

# Chemical Separation and Chromatographic Methods

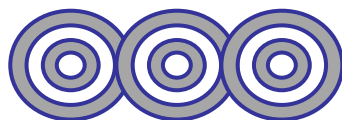
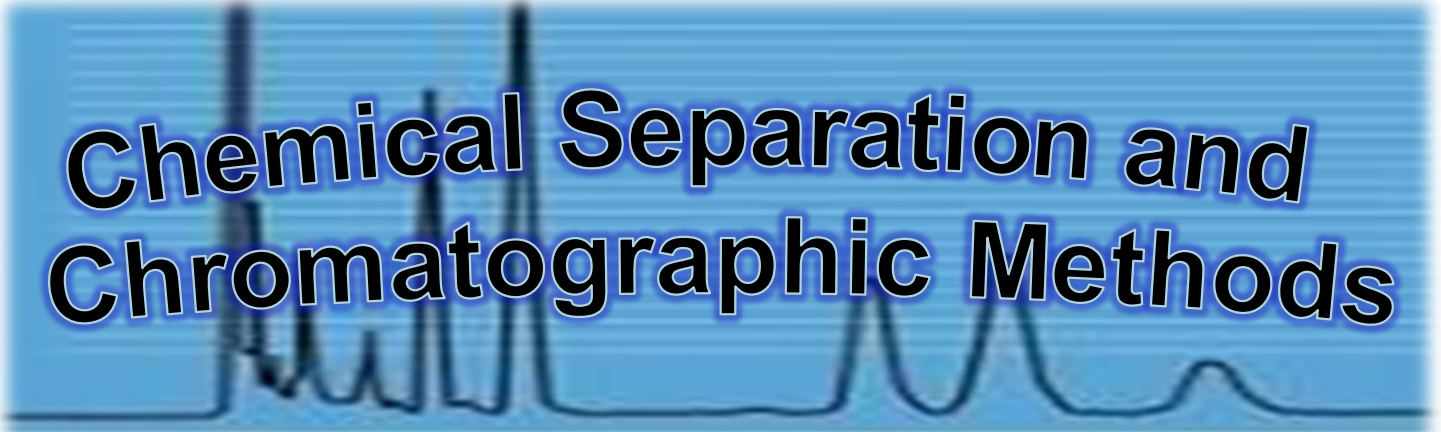

## Gas Chromatography (GC)

**Ahmad Aqel Ifseisi**

Assistant Professor of Analytical Chemistry  
College of Science, Department of Chemistry  
King Saud University

P.O. Box 2455 Riyadh 11451 Saudi Arabia

Building: 05, Office: 1A7 & AA53

Tel. 014674198, Fax: 014675992

Web site: <http://fac.ksu.edu.sa/aifseisi>

E-mail: [ahmad3qel@yahoo.com](mailto:ahmad3qel@yahoo.com)

[aifseisi@ksu.edu.sa](mailto:aifseisi@ksu.edu.sa)



كرسي أبحاث  
المواد المتقدمة  
Advanced Materials  
Research Chair



جامعة  
الملك سعود  
King Saud University



# Gas Chromatography

## Separation by

- **Partition** between gaseous mobile phase and liquid stationary phase supported by inert packing **GLC**.
- **Adsorption** between gaseous mobile phase and solid stationary phase **GSC**.

Separation depends on **temperature**. Based on a wide range of **boiling points** and **polarity**.

Differences in behaviors between the solutes and stationary phases.

# Overview

In GC, the sample is vaporized and injected onto the head of a chromatographic column.

Elution is brought about by the flow of an **inert gaseous** mobile phase, the mobile phase does not interact with molecules of the analyte (i.e., carrier gas); its only function is to transport the analyte through the column.

GC used for **volatile** and **non degradable** compounds by temperature.

Occasionally, it is also possible to **derivatize** (chemically modify) non-volatile and heat degradable target chemicals prior to analysis.

**Derivatization** is a technique used in chemistry which transforms a chemical compound into a product of similar chemical structure, called a derivative.

Generally, a specific functional group of the compound participates in the derivatization reaction and transforms the educt to a derivate of deviating reactivity, solubility, boiling point, melting point, aggregate state, or chemical composition.

Resulting new chemical properties can be used for quantification or separation of the educt.

## For gas chromatography

Derivatization is the process of chemically modifying a compound to produce a new compound which has properties that are suitable for analysis using a GC.

- To permit analysis of compounds not directly amenable to analysis due to, for example, inadequate volatility or stability.
- Improve chromatographic behavior or detectability.

## What does derivatization accomplish?

❖ Increases volatility (i.e. sugars):

- Eliminates the presence of polar OH, NH, & SH groups, the resultant product may be less polar, thus more volatile, allowing analysis by GC.
- Derivatization targets O, S, N and P functional groups (with hydrogens available).
- Polar groups on which give hydrogen bonding relatively nonvolatile compound and tend to adsorb on the active surfaces of the column walls and the solid support. Reduction of this adsorption can be accomplished by derivatization.

❖ Increases detectability, i.e. steroids / cholesterol.

❖ Increases stability.

❖ Enhances sensitivity for Electron Capture Detection (ECD). The introduction of ECD detectable groups, such as halogenated acyl groups, allows detection of previously undetectable compounds.

Bulky and nonpolar groups are often used for this purposes.

## Main types of derivatization

### Silylation

- Replaces active hydrogens (from alcohol) with e.g. TMS (trimethylsilyl group).
- Readily volatilizes the sample. Most prevalent method.

### Alkylation

- Reduces molecular polarity by replacing active hydrogens with an alkyl group.

### Acylation

- Reduces the polarity of amino, hydroxyl, and thiol groups and adds halogenated functionalities to enhances the sensitivity for electron capture detector ECD.

## General silylation reaction

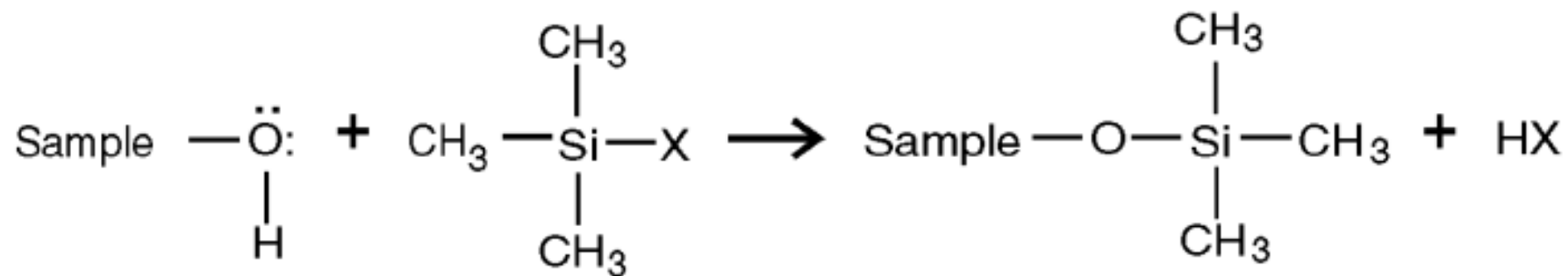

Example;

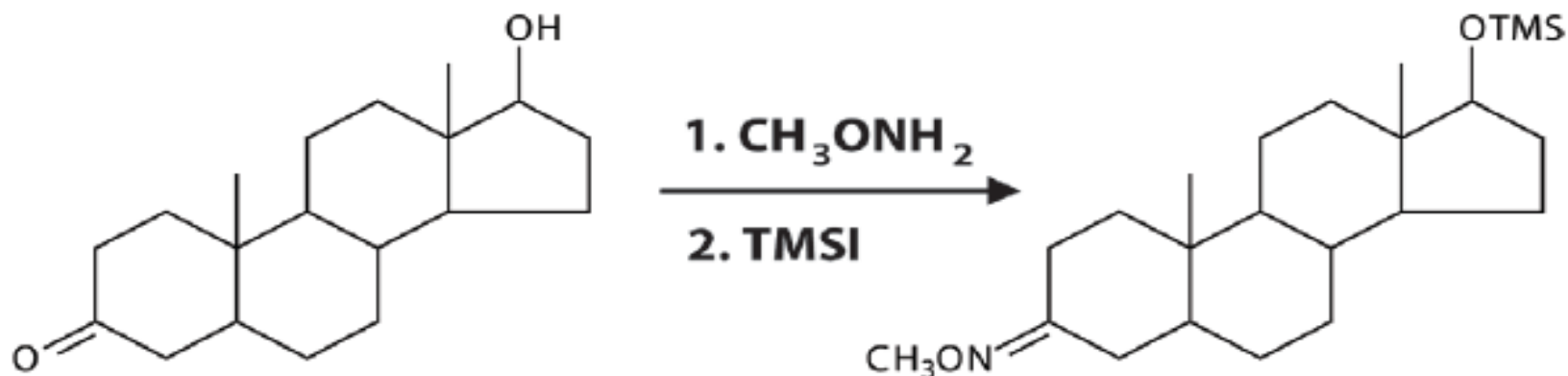

Derivatization reaction of androsterone using TMSI/methoxyamine.

# Overview of GC



Fractional distillation

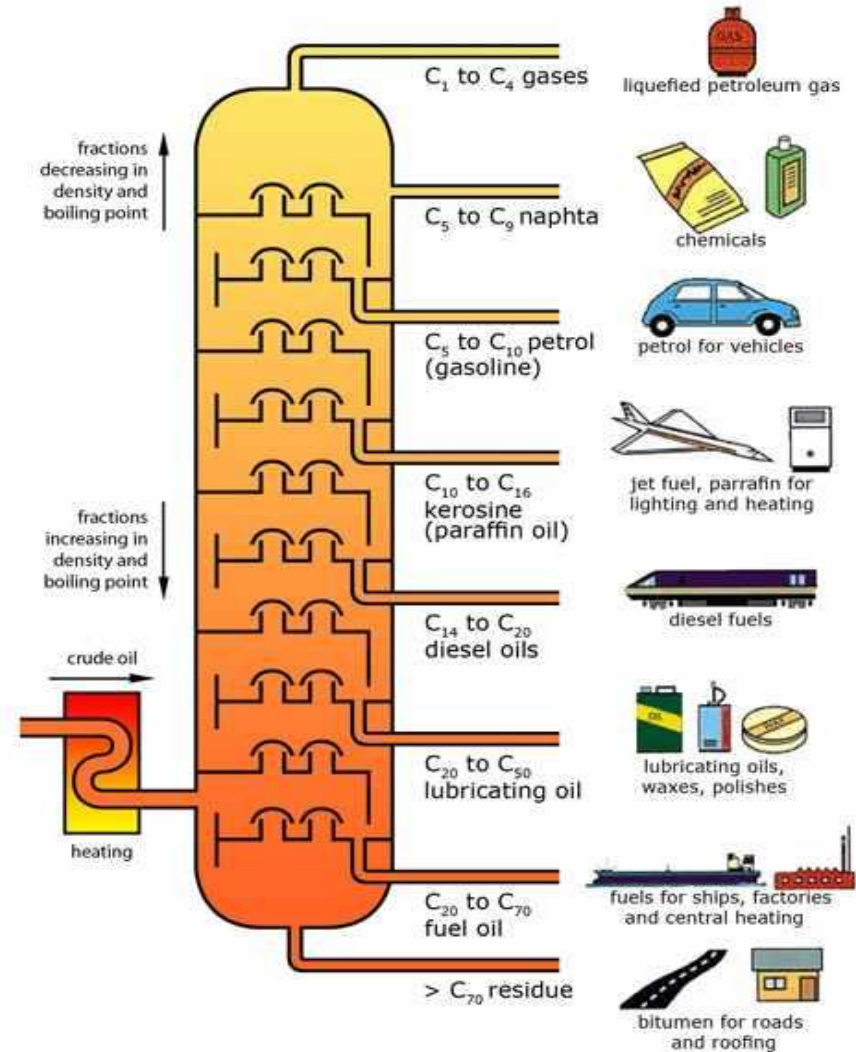



# GC Main Parts

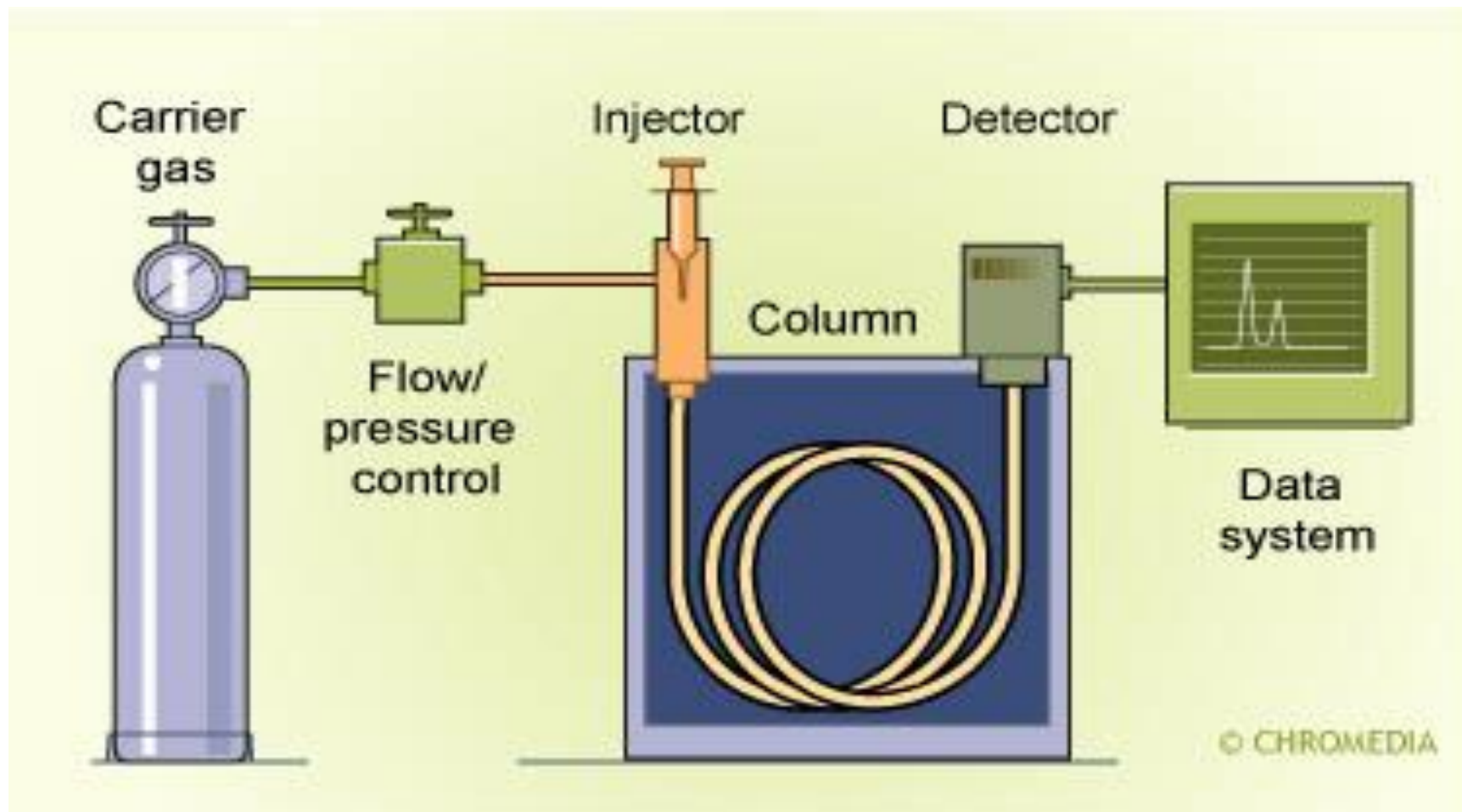

# Main gas chromatograph components

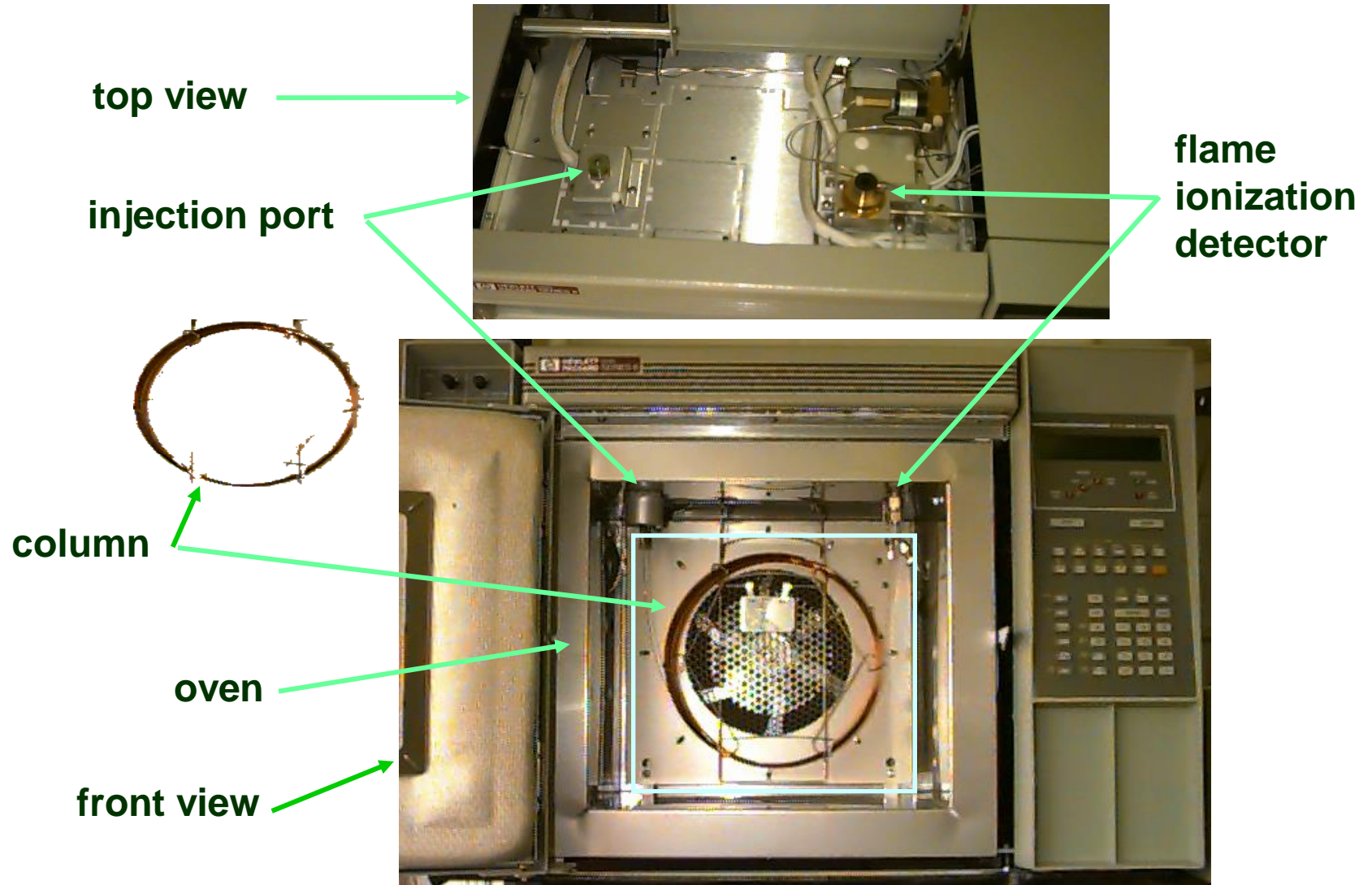

# Carrier Gas

- Chemically inert gases (He, H<sub>2</sub>, N<sub>2</sub> & CO<sub>2</sub>)
- High purity, 99.9995% pure or better
- Free from water and oxygen
- Detector compatibility
- Economic / safety reasons
- Efficiency / speed
- Gas filter used to eliminate impurities such as: water, oxygen, hydrocarbons

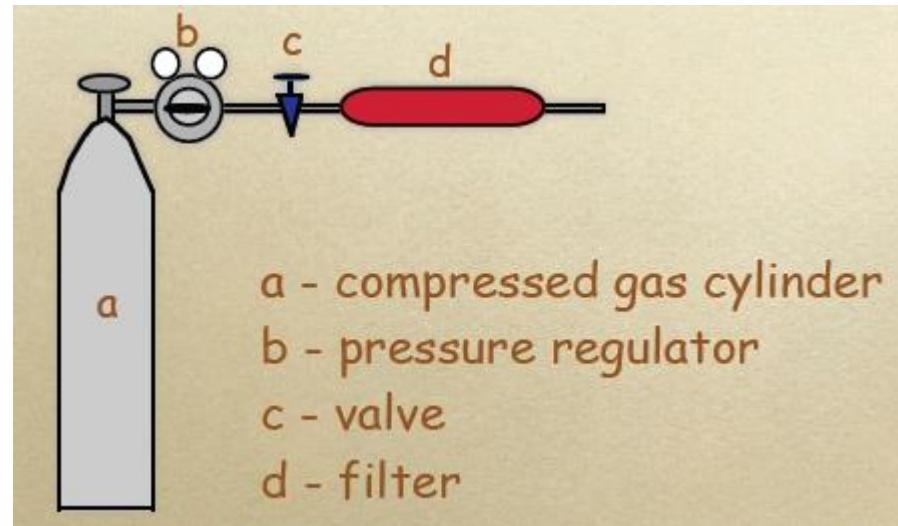

**H<sub>2</sub>**: efficient, cheap and rapid but not safe.

**N<sub>2</sub>**: cheap and safe but less efficient and not inert.

**He**: efficient, rapid, inert and safe but relatively expensive.

# Carrier gas supply

Pressure regulators:

- Reduce pressure of gas
- Control the flow rate



**double stage pressure regulator**

# Flow meters



electronic flow meter



rotameter



$$\text{Flow rate} = \frac{\text{volume (mL) between marks}}{\text{transverse time (min)}}$$



soap bubble flow meter

The gas flow rate is an important parameter in gas chromatography. It must be measured as accurately as possible :

**- Bubble flow meter:**

For the determination of gas flow at the column or detector, simple use and good accuracy.

**- Rotameter:**

Can be used either before or after the column; the flow corresponds to the height of a little ball floating in glass tube which must be first calibrated with the same gas.

**- Electronic pressure control (EPC) :**

Electronic sensor measuring the gas flow rate EPC; gives a rapid and accurate value over a large flow range but it must be first calibrated for the corresponding gas.

# Injector

- Role of injectors
  - Works as an inlet for the sample.
  - It vaporizes and mix the sample with the carrier gas before the sample enters the head of the column.
- The injection volume has a great effect on the quality of the separation.
- The type of column used in the analysis sets the mode of injection.

# Direct vaporization injector

## For packed columns

- Uses a metal tube with a glass sleeve or insert.
- The glass insert is swept by the carrier gas and heated to the vaporization temperature.
- Contains a septum made of silicone rubber that allows the syringe needle to pass through it into the system.

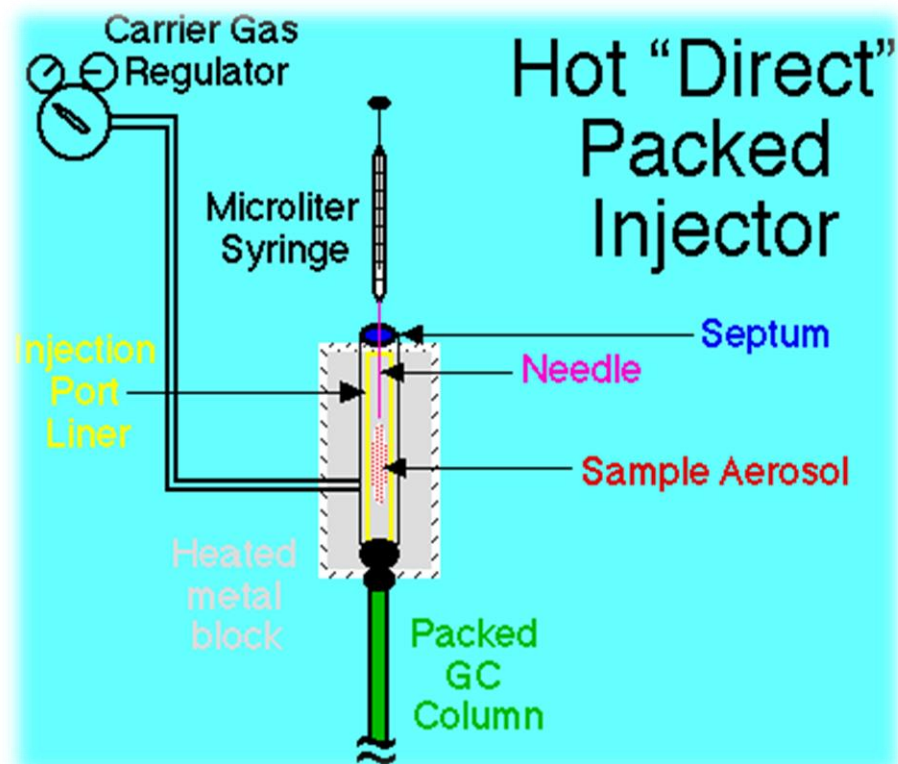



# Split / Splitless injector

## For capillary columns

- Operate in two modes, with or without flow splitting.

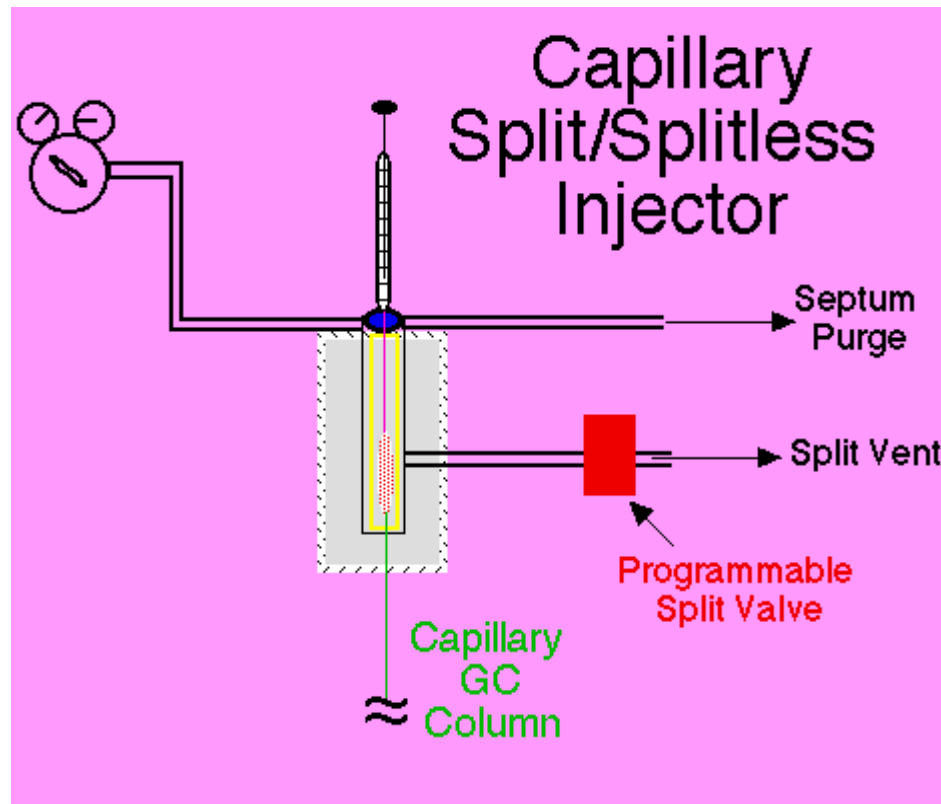

# Split mode

- Carrier gas arrives in the vaporization chamber with a relatively large flow.
- A vent valve separates the carrier gas flow into two parts of which the smallest enters the column.
- The split ratio varies between 1 : 10 and 1 : 500.

## Split Injection

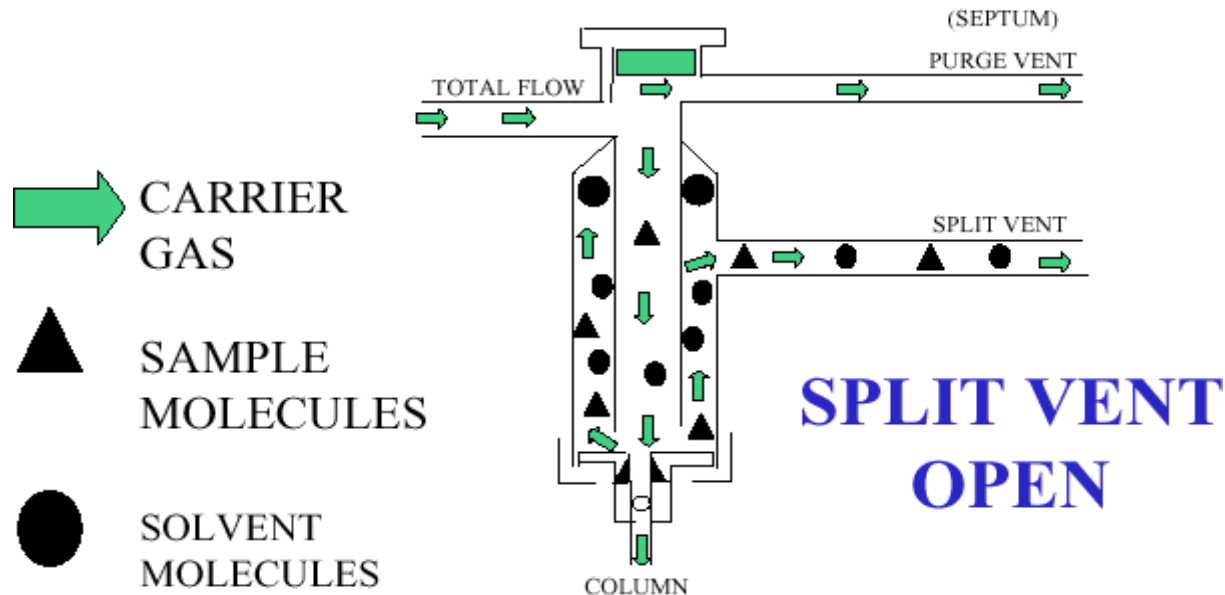

# Splitless mode

- All sample to column.
- Best for quantitative analysis.
- For trace analysis.

## Splitless Injection

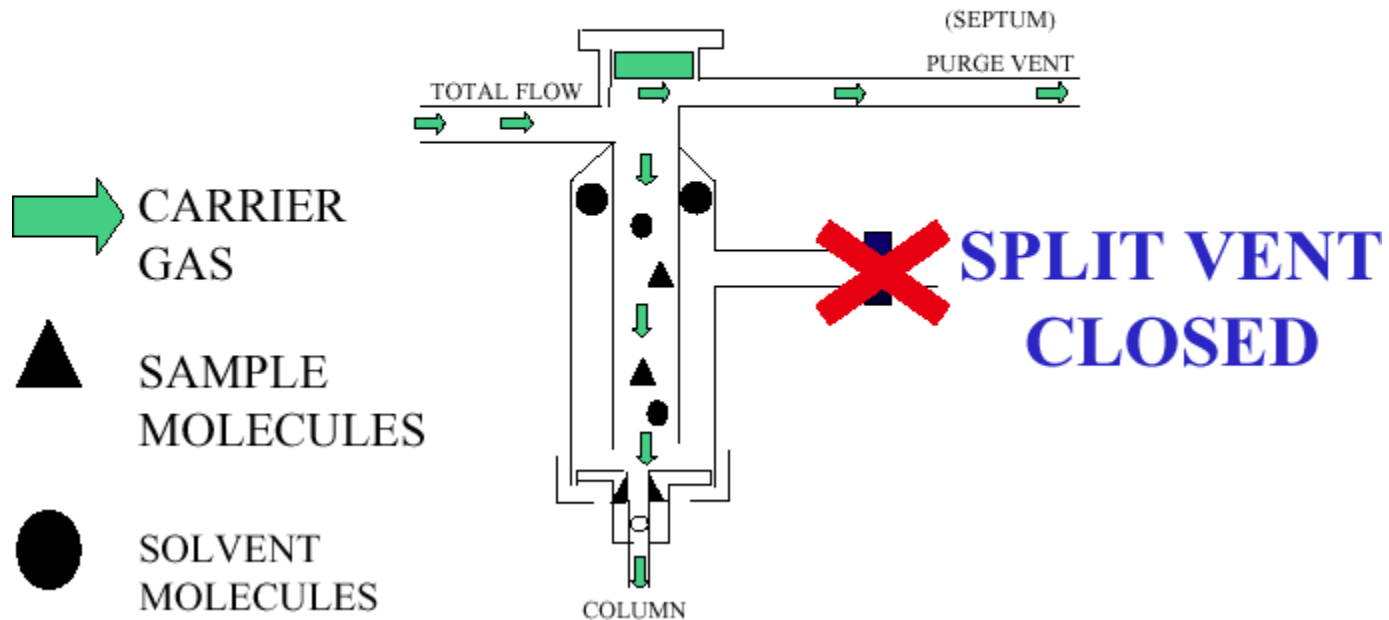

A: Split injection

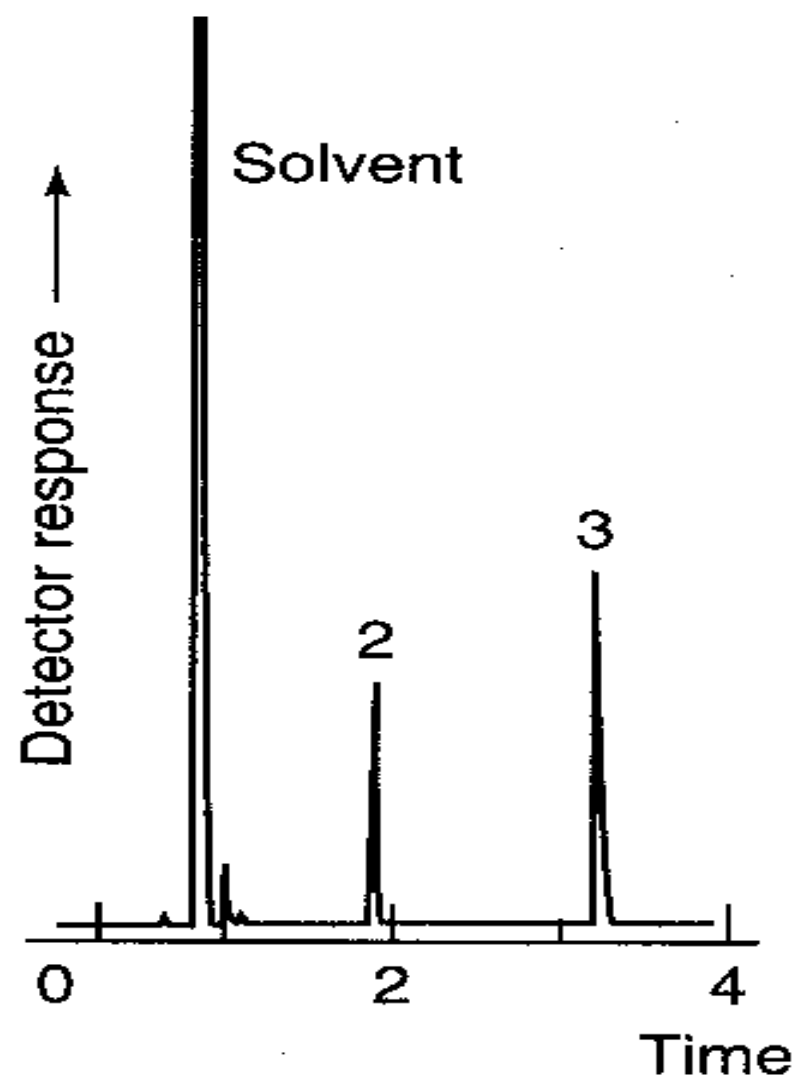

Split vent closed

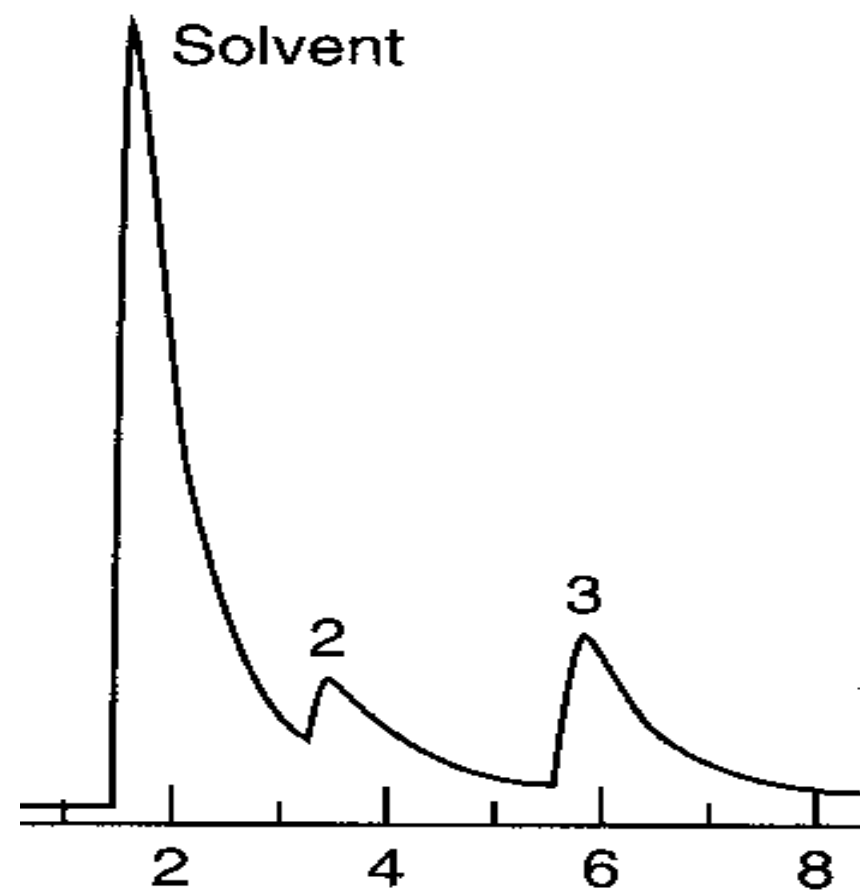

# The septum

- The most common injection method is where a microsyringe is used to inject sample through a **rubber septum** into a vapouriser port at the head of the column.
- It allows an easy injection with a simple syringe and maintains seal to avoid gas leaks.
- The septum material is an elastomere temperature-resistant with a maximum temperature limit which should be respected during operation.
- The septum dimensions (diameter and thickness) depends on the instrument model.
- The septum should be checked and changed periodically.
- The injection port temperature should be less than the limit temperature of the septum.
- A decrease of the carrier gas pressure or an increase of retention times could be due to a damaged septum.

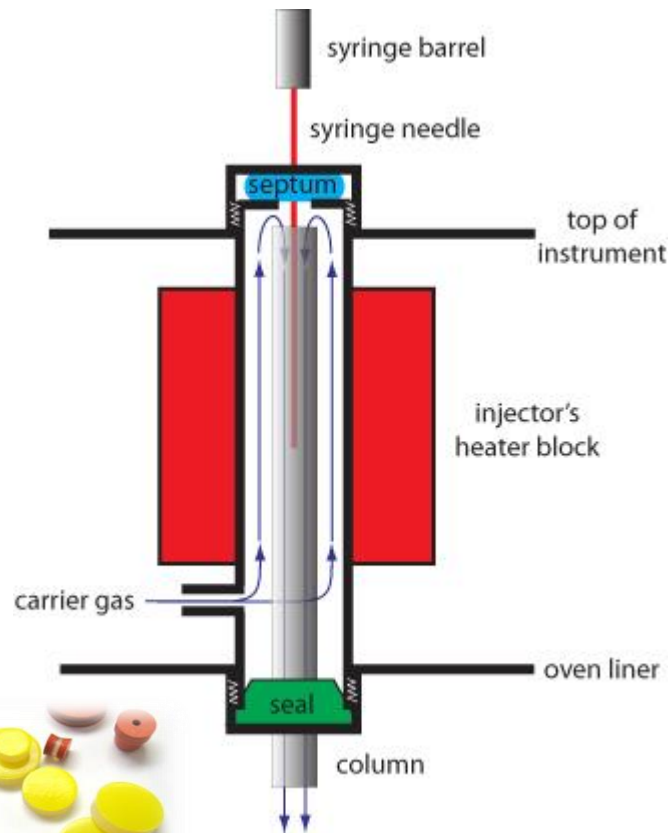

# The liner

- Presents a hot and inert surface and a suitable volume for a rapid vaporisation of the sample.
- The liner is generally made of glass but some models may have also steel liners.
- In some chromatographs the injection port does not have liner, the sample is directly injected in the column then vaporized.
- The liner must be regularly checked or changed, it can be contaminated by degradation or non-volatile products.



Straight tube liner.



Gooseneck design. Useful in trace analysis.



Double gooseneck design. Useful in trace analysis with active compounds and helps prevent backflash.



Cyclo double gooseneck design. Useful for trace, active, and dirty samples.



Recessed gooseneck design. Useful for use with dirty samples.

# Sample injection

It allows a rapid and simple introduction of the sample to be analysed in the gas chromatograph.

There are two main injection systems, depending on the nature of sample:

- **Injection port:** for introduction of liquids and solutions.
- **Sampling loop injection:** for introduction of gas samples.

# Injection port

For introduction and volatilisation of the liquid and solution samples.

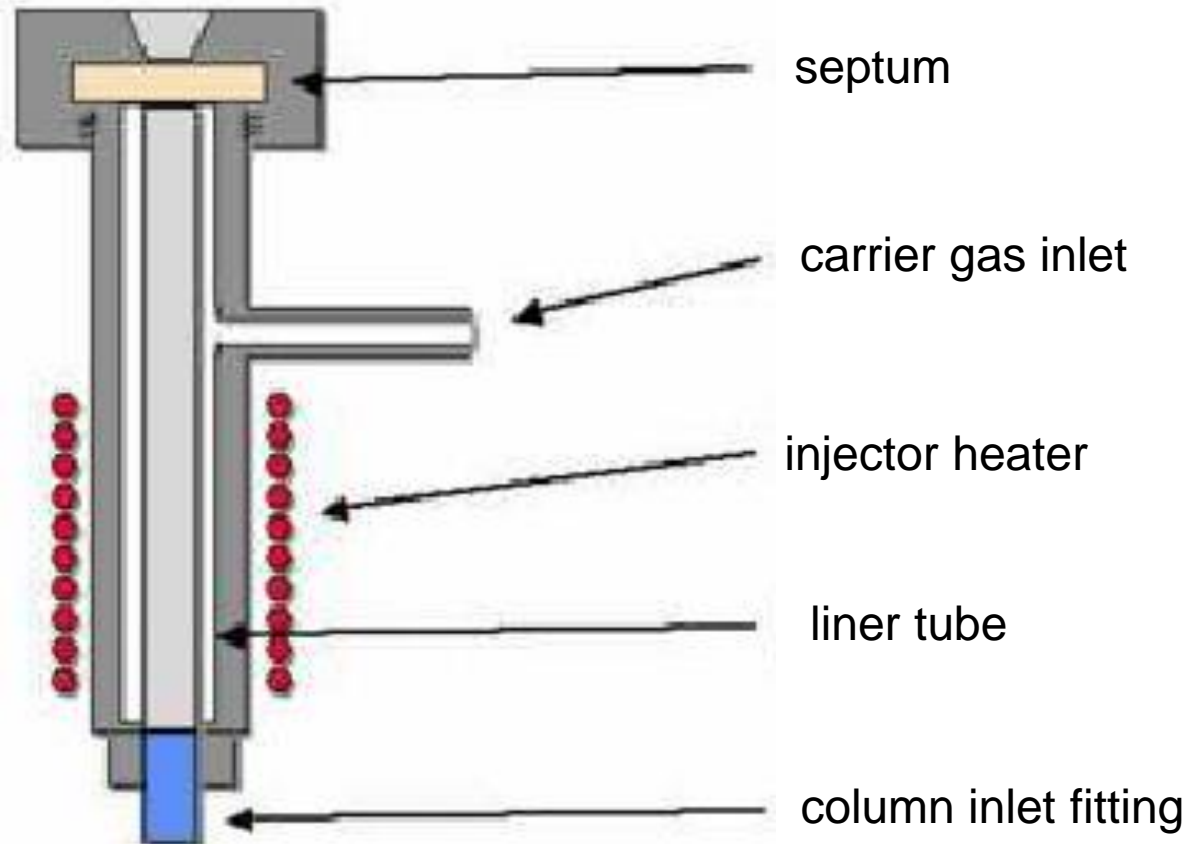



# Injection port for liquid samples

- Allows the rapid introduction and volatilisation of the liquid sample in the chromatograph.
- Injection port temperature must be high enough to quickly evaporate the sample without thermal degradation.
- The injection temperature is 20° higher than the boiling point of the less volatile constituent of the mixture.
- To avoid condensation of the sample in the injection port, the injector temperature must be higher than column temperature:

$$T_{\text{injector}} > T_{\text{column}} \text{ (about } 50^{\circ}\text{C)}$$

- The volume of the injection port must allow the volatilisation of the liquid sample and avoid the excessive dead volume.

# Injection techniques

Bad injection techniques are one of the major sources of errors in gas chromatography, both qualitatively and quantitatively.

if an automatic injector (auto-injector or auto-sampler) is available, it is better than manual injection

- Syringe injection.
- Gas sampling loop/valve.
- Purge and trap.
- Solid phase microextraction (**SPME**).

# Syringe injection

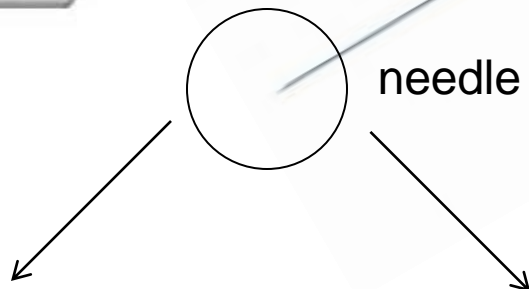
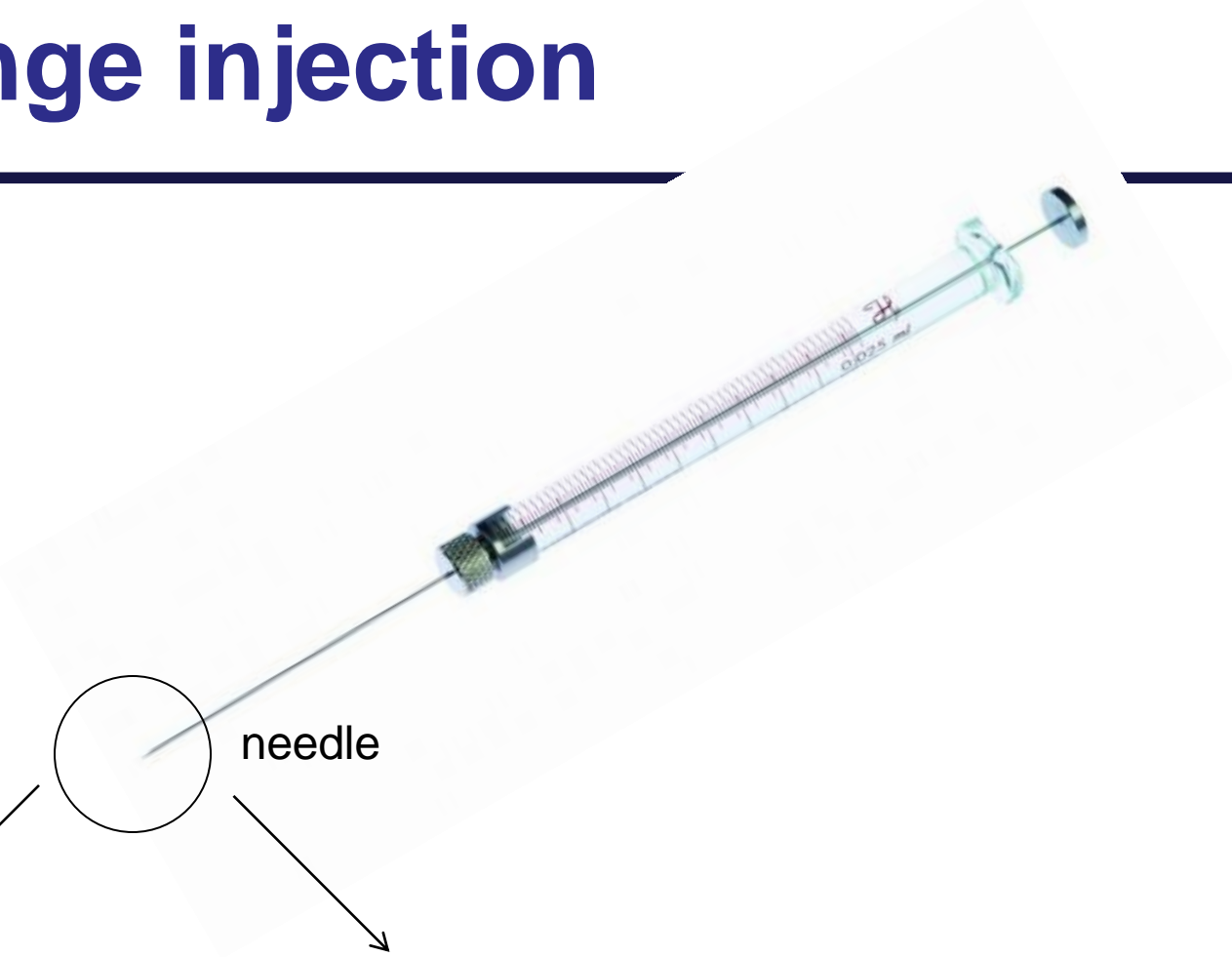
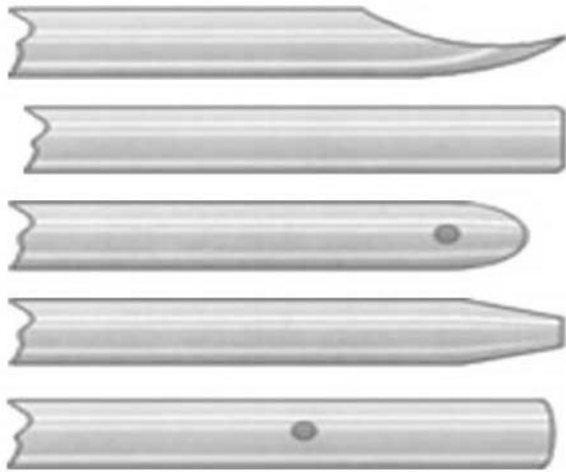

Bevel

Blunt



The syringe used to introduce an accurate volume of the liquid or gas sample in the injector.

Several syringe models are available: from 1mL to several cm<sup>3</sup>, with various options: fixed or removable needle, adaptor, sharp or round needle.



Introduce the sample with a microsyringe:

- Liquids 0.1-10  $\mu\text{L}$  (typical).
- Gases 0.5-5 mL (typical).

## Example (effect on the separation quality)

The sample should be injected and the needle removed from septum as quickly as possible



**slow injection**

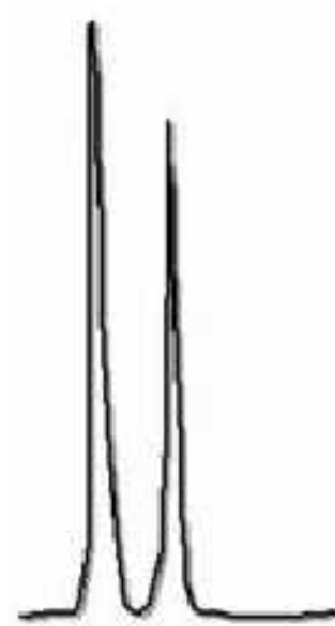

**fast injection**

# Needle volume correction

Because of the remaining sample in the syringe needle

Load sample into syringe

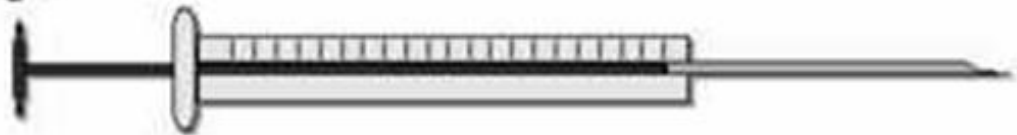

Read the volume



Rapidly inject the sample - remove the syringe

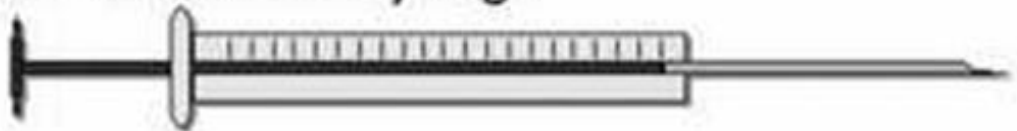

Start run then pull back on syringe



Subtract the needle volume from the total

# Syringe loading methods

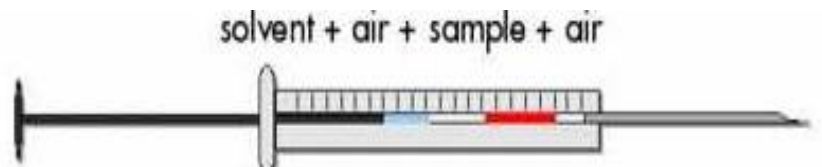
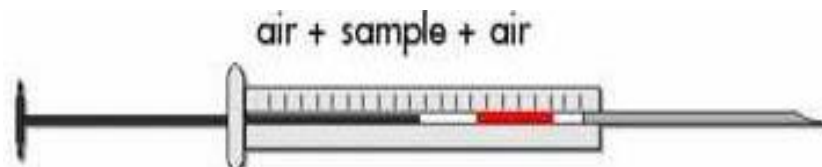
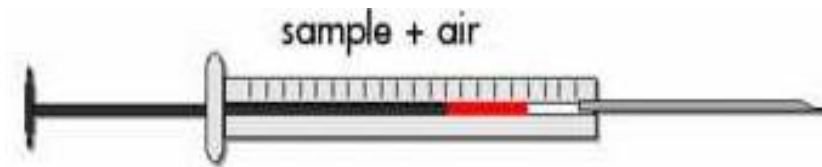
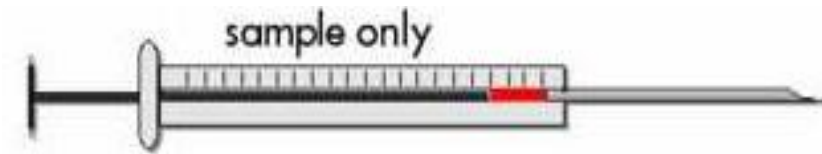

# Hot needle method

- Draw sample into syringe barrel.
- Draw 2-3 $\mu$ L air into barrel.
- Insert needle into injection port and allow to heat for a few seconds.
- Rapidly inject sample and withdraw the needle.
- Sample should be injected as a plug.

This insures that all sample is injected and the hot needle assist in solvent volatilization.

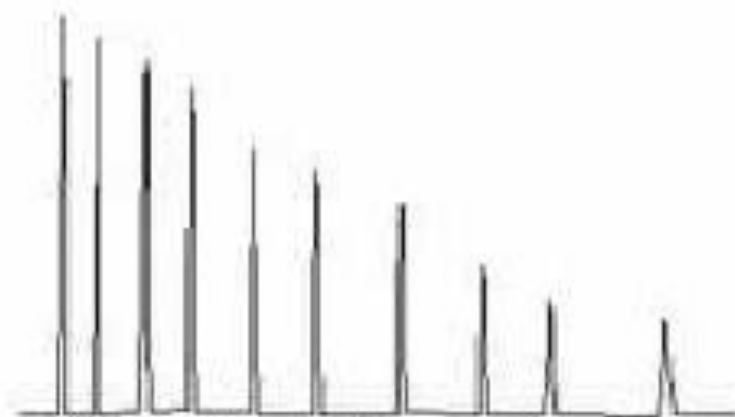

Filled needle method

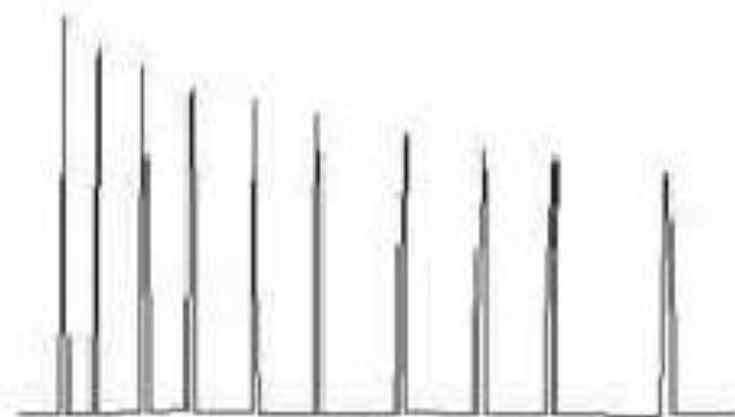

Hot needle method



# Gas sampling loop / valve

- Introducing a constant amount of a gas can be difficult with a syringe.
- Valves give better reproducibility.
- Require less skill.
- Can be easily automated.



6 port valve

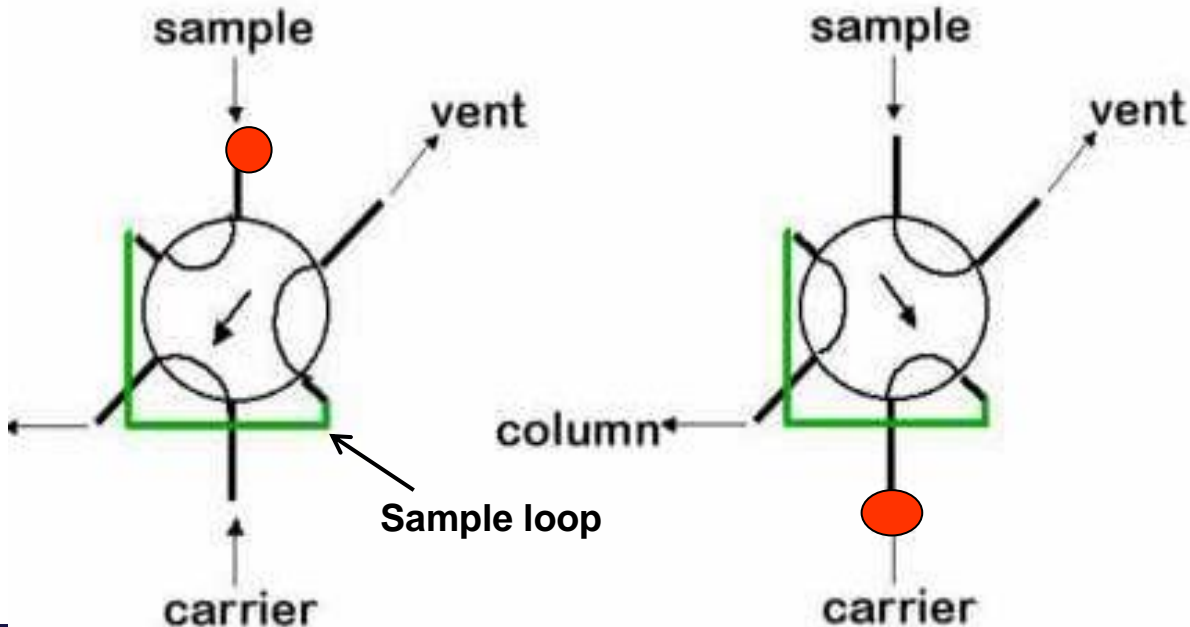

# Purge and Trap

- The sample is permanently purged with carrier gas, which carries the analytes to the trapping medium.
- Lower detection limit.
- Useful for concentrating insoluble or poorly soluble volatile organic compounds (VOCs).

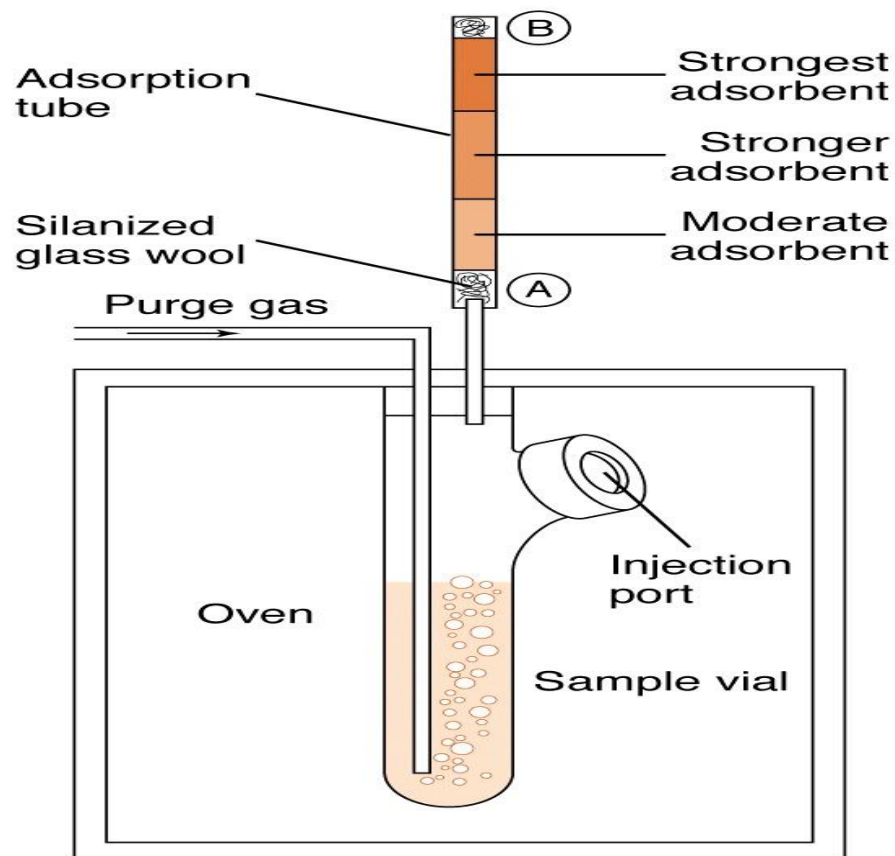

# Purge and trap step

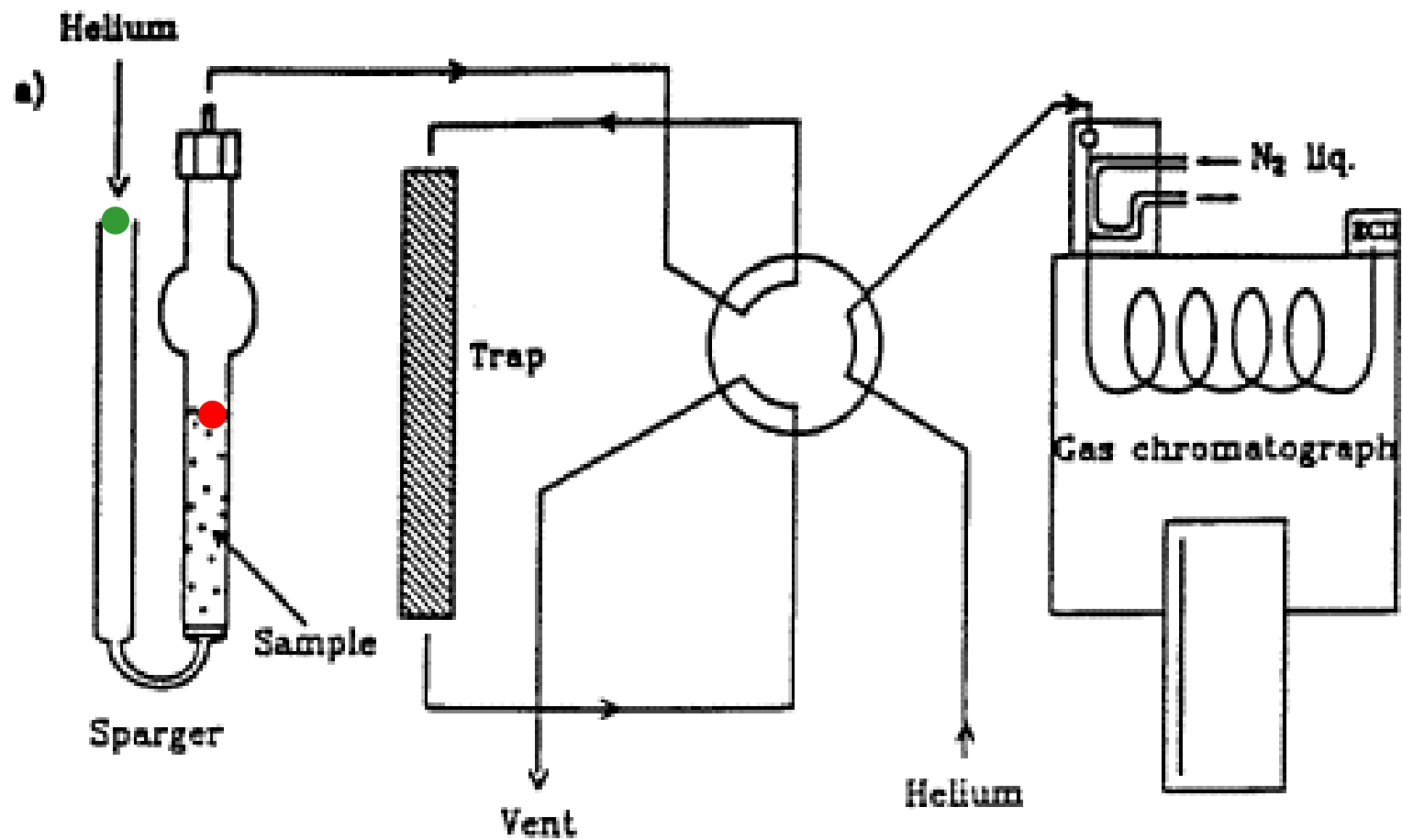

# Desorption step

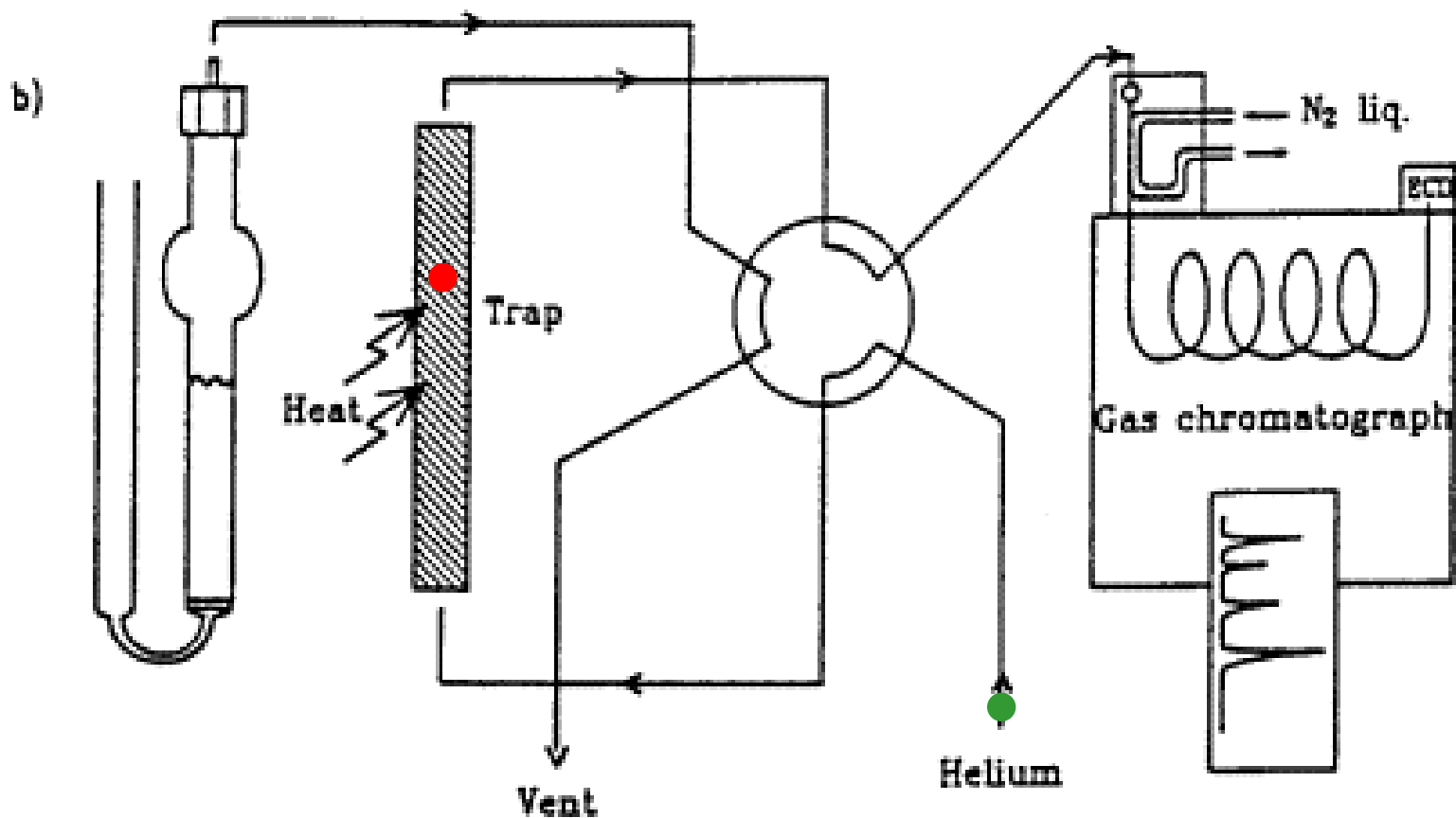

# Solid Phase Microextraction (SPME)

A technique that uses a short, thin, silica fused rod which is coated with absorbent polymer (fiber) for extraction of compounds.

Principle: Equilibrium partitioning of compounds between the fiber and liquid sample.

It is fast, sensitive, inexpensive, portable and solvent-free.

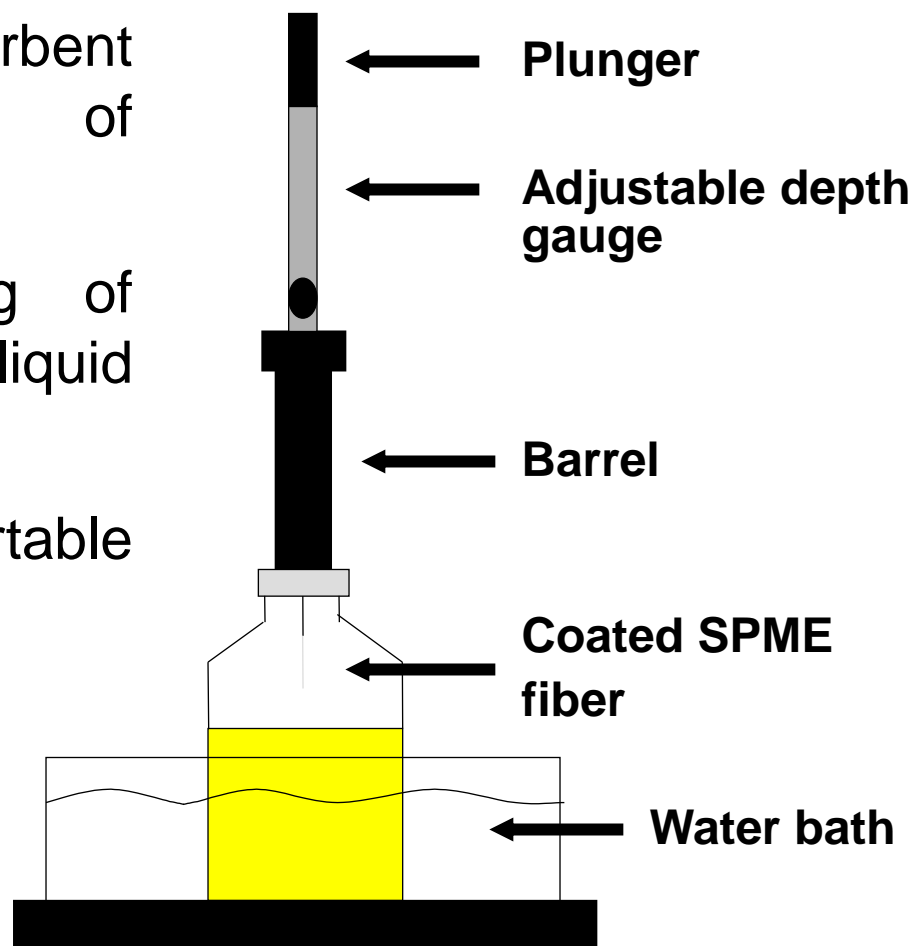

Pierce sample septum with metal needle

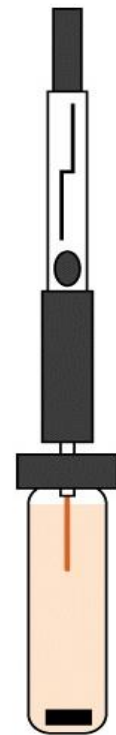
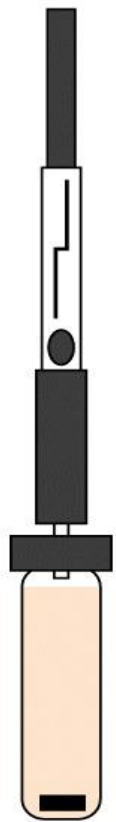

Retract fiber and withdraw needle



Expose fiber to solution or headspace for fixed time with stirring

Pierce chromatography septum with metal needle

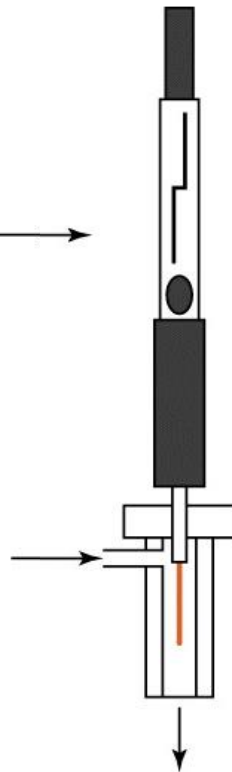
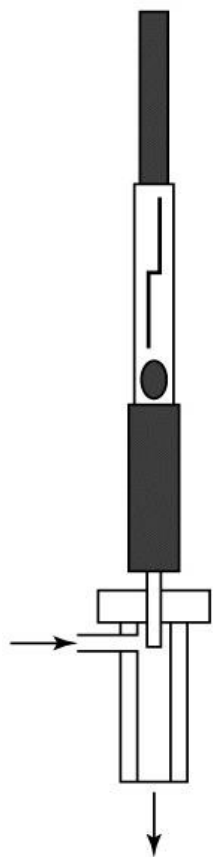

Retract fiber and withdraw needle

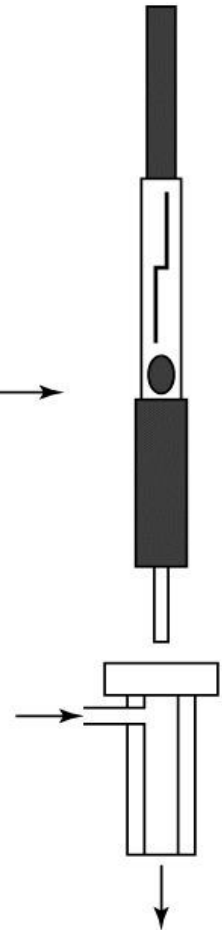

Expose hot fiber to carrier gas for fixed time

# Oven

Column temperature is an important variable that must be controlled for precise work, so the column is ordinarily housed in a thermostated oven.

The optimum column temperature depends upon the **boiling point** of the sample and the degree of separation required.

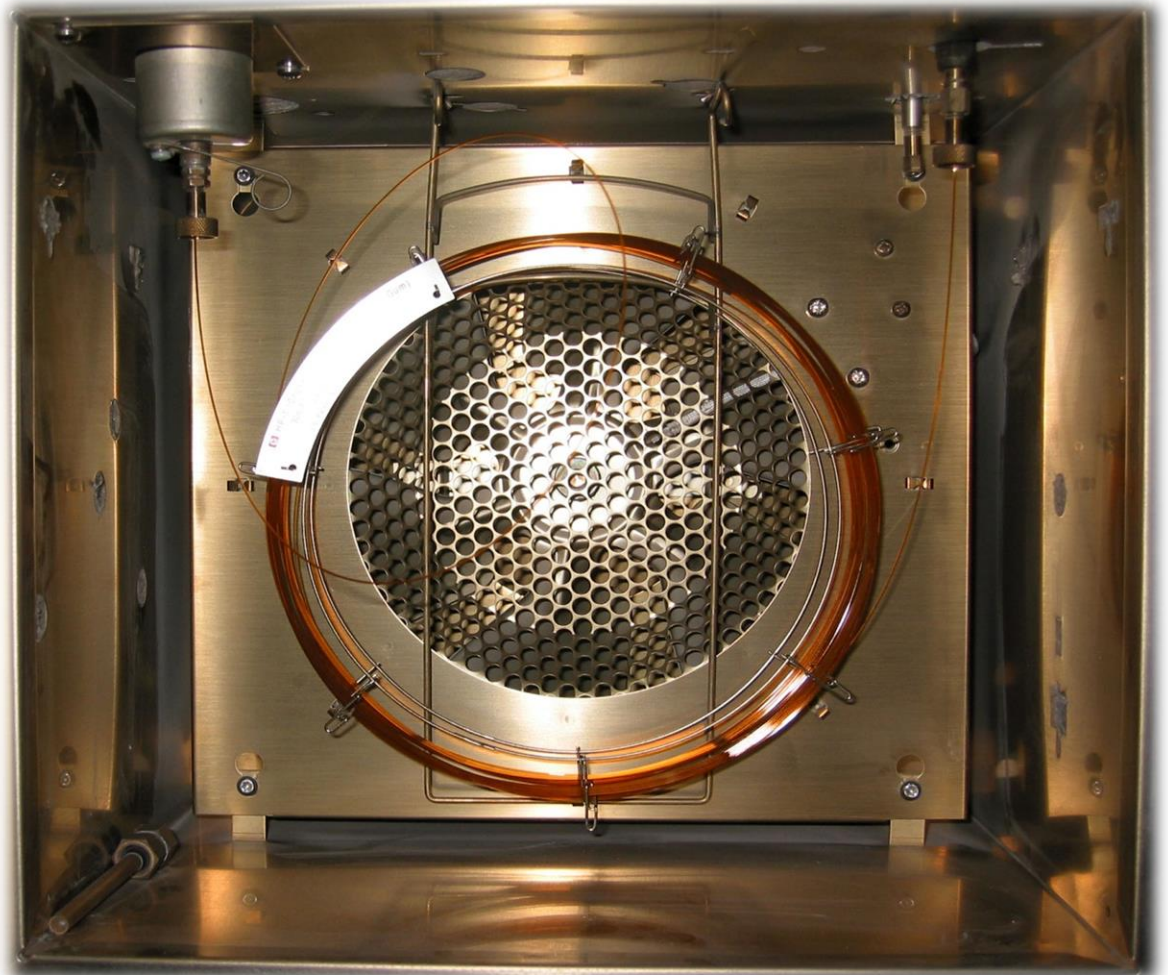

# Temperature control

↙

## Isothermal

150 °C

A horizontal line representing a constant temperature of 150 °C over time.

↘

## Gradient

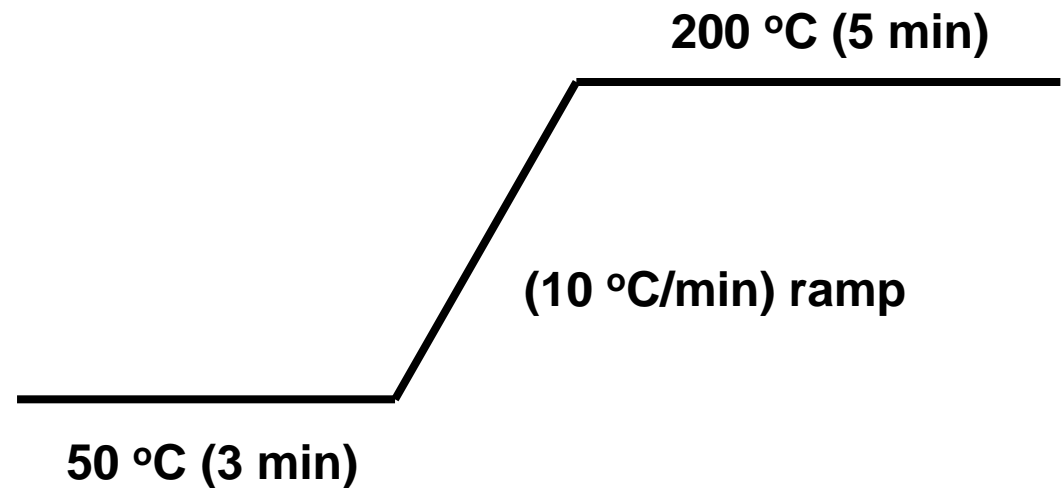

Some GC's allow for a more complex program



If the temperature is held constant during the entire analysis it is isothermal.

For samples with a broad boiling range, it is often desirable to employ **temperature programming**.

Temperature program vary the temperature during the analysis.

- With homologues, the retention time increases exponentially with the number of carbon.
- As  $t_R$  increases, width increases and the height decreases, making detection impossible after a few peaks have eluted.
- Since solubility of a gas in a liquid decreases as temperature goes up, we can reduce the retention of a material by increasing  $T_{\text{column}}$ .

# Temperature program

## Factors to consider

- Changes in volatility of solutes.
- Stability of solutes.
- Flow rate changes.
- Stability of stationary phase.

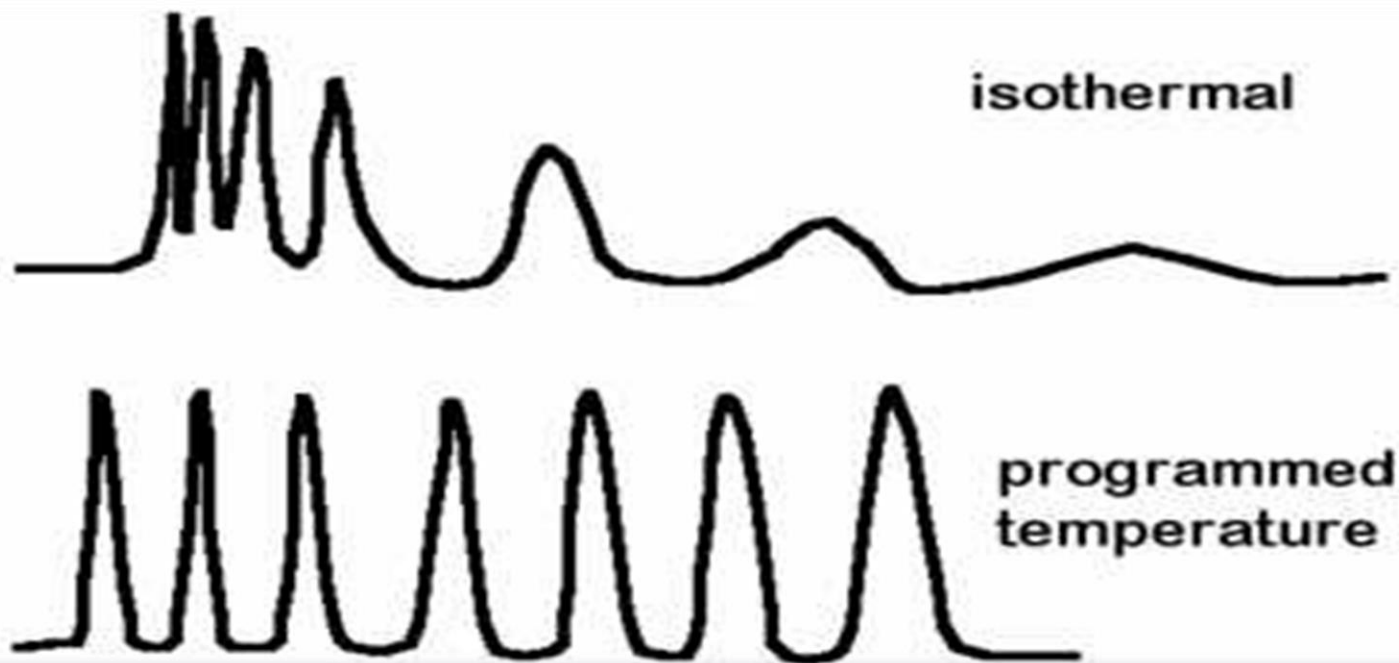

# Column

Although it's usually the smallest part, the column is considered the most important component in any column chromatographic system (heart of chromatographic system).

Columns can be classified by tubing diameter and packing type.

- Packed columns.
- Open tubular capillary columns.
  - Wall-coated open tubular (**WCOT**)
  - Support-coated open tubular (**SCOT**)
  - Fused silica open tubular (**FSOT**)
- Monolithic columns.

A broad variety of tube sizes (dimensions) and materials, such as stainless steel, fused silica and glass tubes, have been used as molds for GC



# Packed columns

- Made of stainless steel or glass.
- Diameters between 2 and 4 mm.
- Length from 0.5 to 5 m.
- Filled with porous particles, which act as support of the stationary liquid phase.
- The internal surface of the tube is treated to avoid catalytic interactions with the sample.
- Carrier gas flow rate of typically 10 to 40 mL/min (high gas consumption).
- Although they are still used in approximately 10% of cases for routine GC work, packed columns are not well adapted to trace analyses.

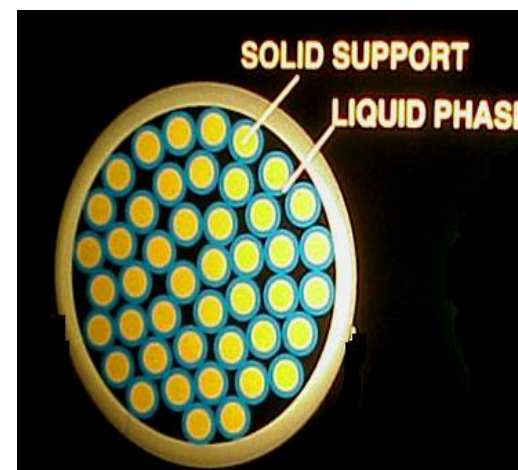
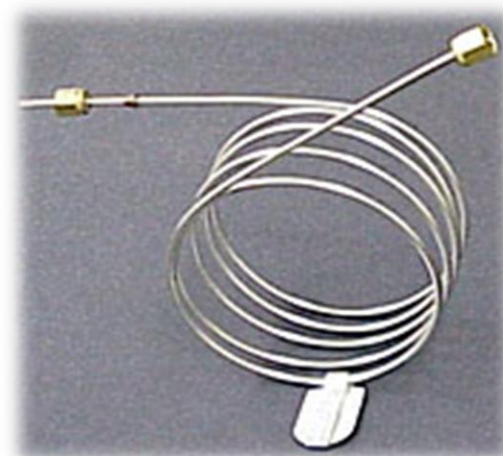

# Open tubular columns

- Made of fused silica.
- The internal diameter varies from 0.1 to 0.5 mm - length from 5 to 100 m.

Open tubular columns are three classes:

- **WCOT** columns:

Wall coated open tubular, are simply tubes coated with a thin layer of the stationary phase, which is the most popular one.

- **SCOT** columns:

Support coated open tubular, in which a stationary phase is a solid support film coated with stationary liquid phase.

- **PLOT** columns:

Porous layer open tubular, in which the inner surface of the capillary is lined with a thin films of a support material, that designed to increase the loading capacity of the column.

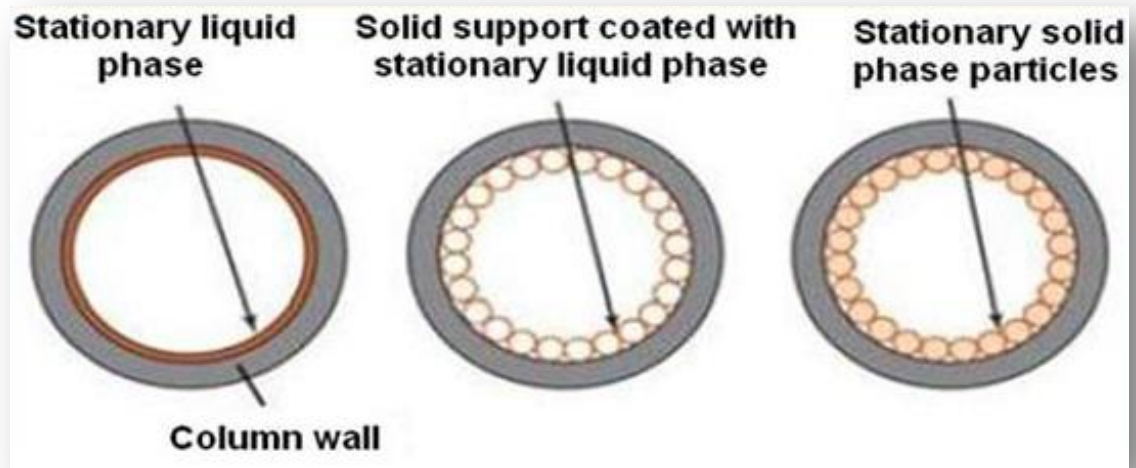

Fused silica is a synthetic quartz of high purity. A protective coating is applied to the outer surface with polyimide being the most common coating material. The polyimide coating is responsible for the brownish color of fused silica capillary columns.

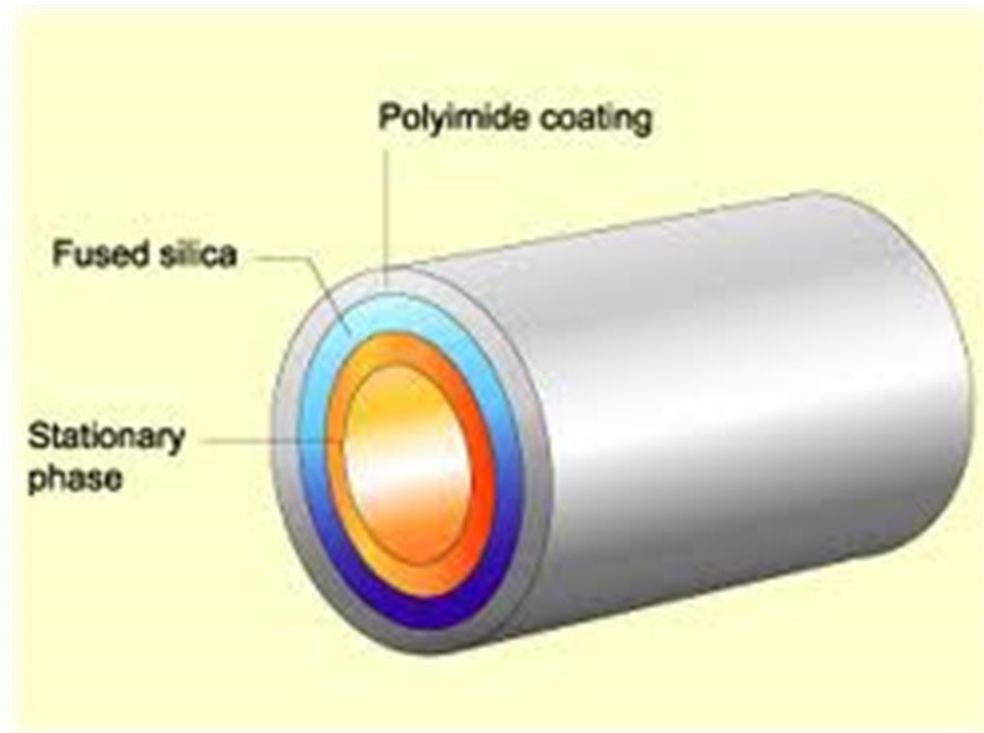
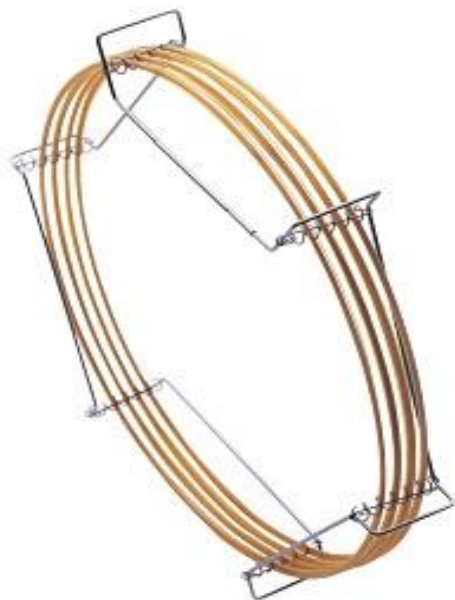

# Monolithic columns

Monoliths are a single block piece of continuous materials made of highly porous rods with two types of bimodal pore structure distribution (macropores and mesopores).

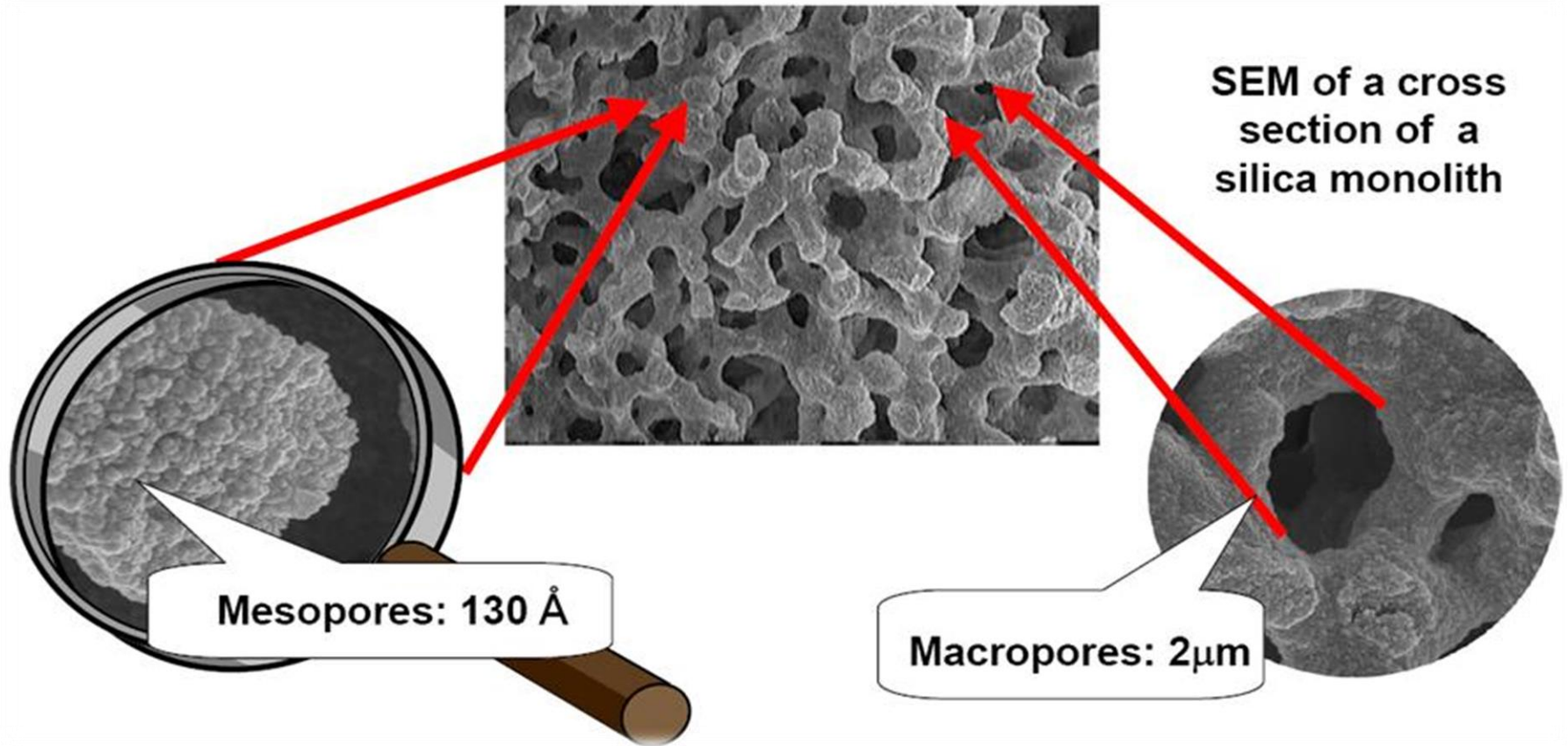

SEM of the macroporous and mesoporous structures in a monolithic silica rod. Macropores dramatically increase the column porosity, which reduce the analysis time, while mesopores form the fine porous structure and provide large active surface area for high efficiency separations.



**Two types of monolithic columns have been developed for chromatography:**

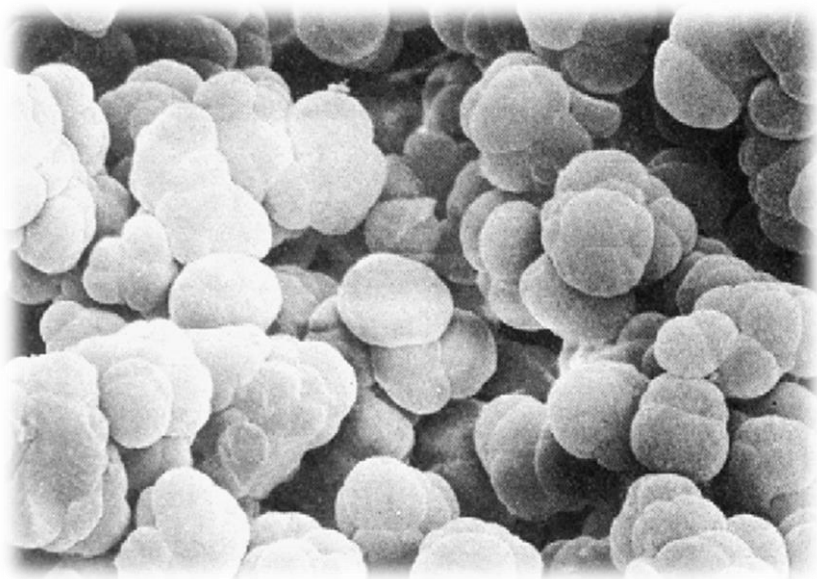

**Organic polymers  
e.g. polymethacrylates, polystyrenes  
or polyacrylamides**

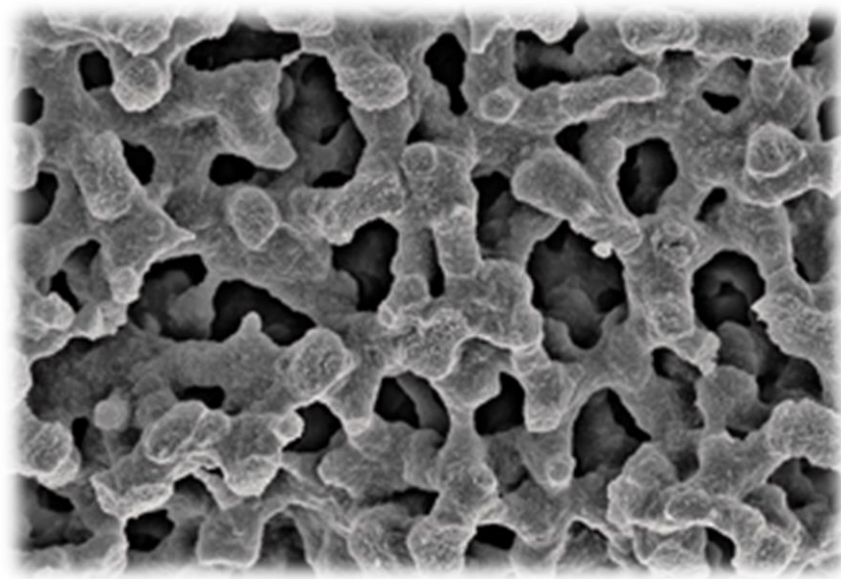

**Inorganic polymers  
e.g. polysilicates,**

# Packed vs. Capillary columns

	Packed	Capillary
length, M	0.5 - 5	5 - 100
ID, mm	2 - 4	0.1 - 0.7
flow, ml/min	10 - 60	0.5 - 15
head pressure, psig	10 - 40	3 - 40
total plates	4000	250,000
capacity	10 $\mu$ g/peak	100ng/peak
film thickness, $\mu$ m	1 - 10	0.1 - 8

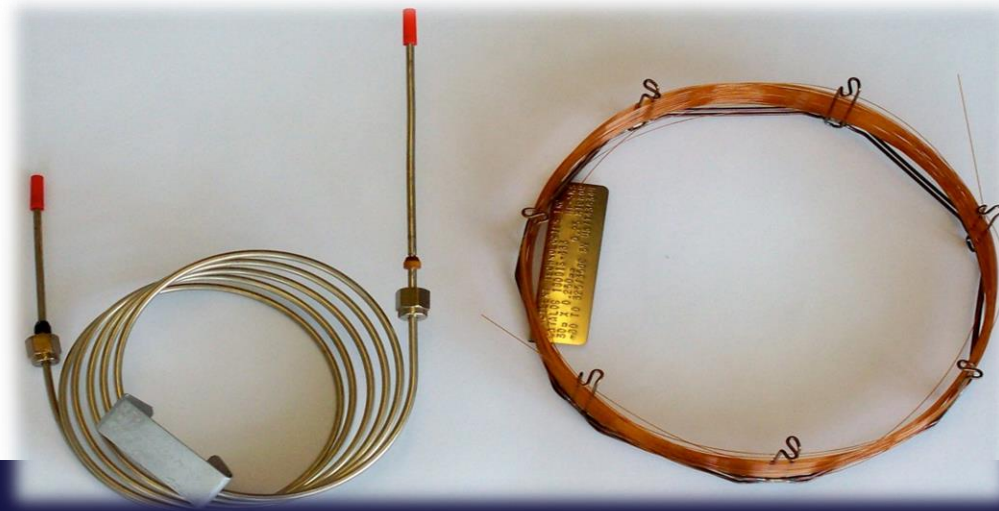

# Packed vs. Open tubular columns

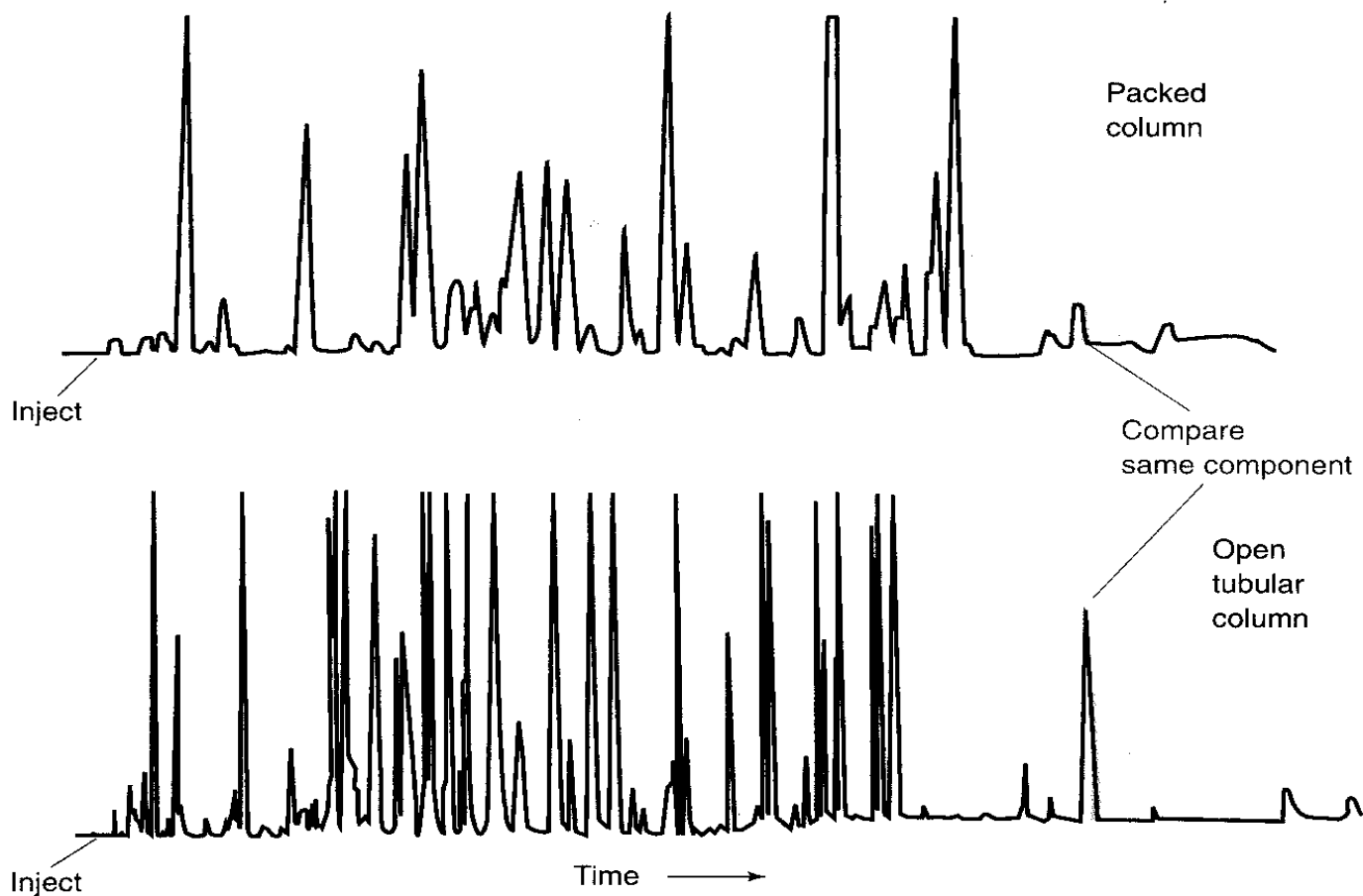

**Figure 24-3** Gas chromatographic separation of a perfume oil on a 2-mm-diameter  $\times$  1.5-m-long packed column (upper trace) and a 0.25-mm-diameter  $\times$  30-m-long open

# Principle of separation

Like dissolve like (like attract like)

Non-polar stationary phases best for non-polar analytes

Polar stationary phases best for polar analytes

Stationary Phase	Common Trade Name	Maximum Temperature, °C	Common Applications
Polydimethyl siloxane	OV-1, SE-30	350	General-purpose nonpolar phase; hydrocarbons; polynuclear aromatics; drugs; steroids; PCBs
Poly(phenylmethyldimethyl) siloxane (10% phenyl)	OV-3, SE-52	350	Fatty acid methyl esters; alkaloids; drugs; halogenated compounds
Poly(phenylmethyl) siloxane (50% phenyl)	OV-17	250	Drugs; steroids; pesticides; glycols
Poly(trifluoropropyldimethyl) siloxane	OV-210	200	Chlorinated aromatics; nitroaromatics; alkyl-substituted benzenes
Polyethylene glycol	Carbowax 20M	250	Free acids; alcohols; ethers; essential oils; glycols
Poly(dicyanoallyldimethyl) siloxane	OV-275	240	Polyunsaturated fatty acids; rosin acids; free acids; alcohols

# Polysiloxanes ...

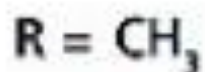
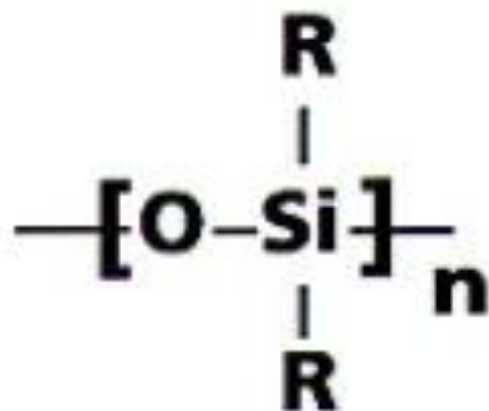

methyl



cyanopropyl

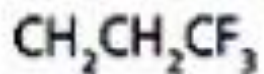

trifluoropropyl



phenyl

# Stationary phases

100% dimethyl  
polysiloxane  
*Least polar phase*

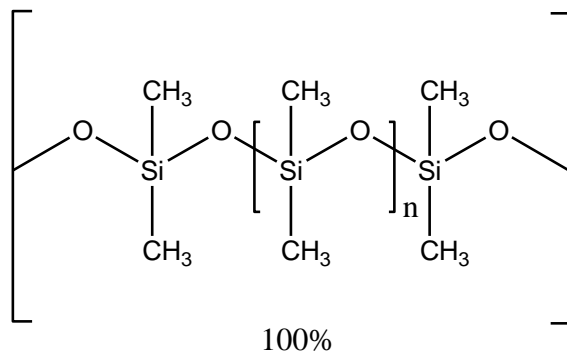

5% diphenyl  
95% dimethyl  
polysiloxane  
*Non-polar phase*

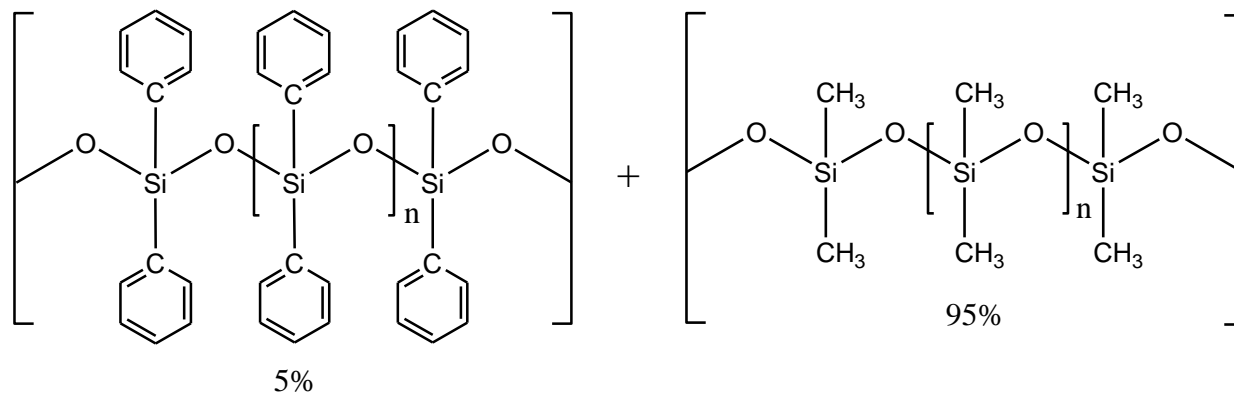

14%  
cyanopropylphenyl  
86% dimethyl  
polysiloxane  
*polar phase*

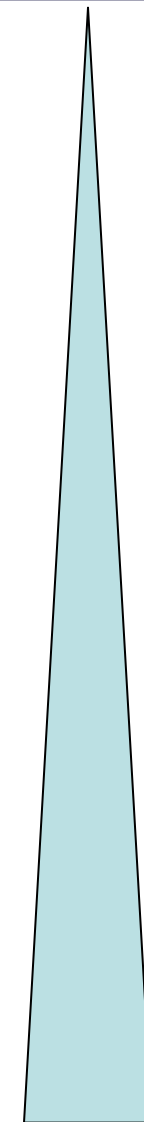
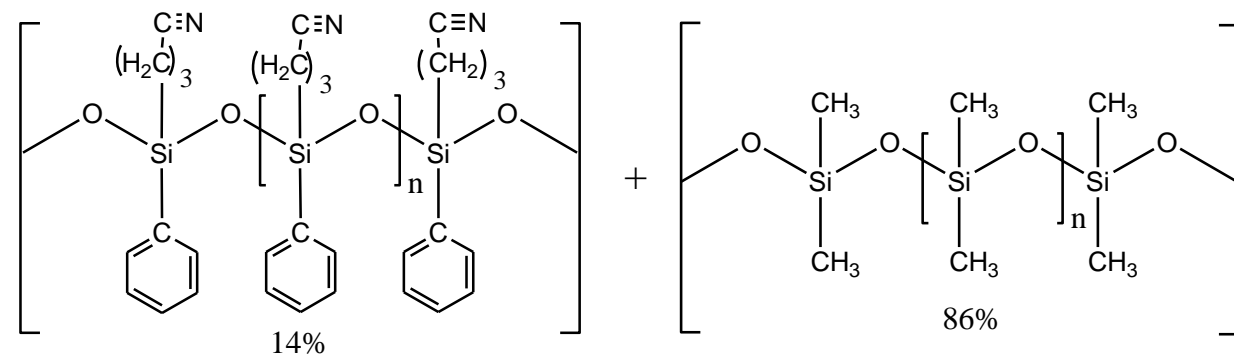

**Polarity**

# Detector

- The detector serve to detect the appearance of analytes at the end of the column (convert a physical or chemical property to electrical signal).
- Provide information about the identity of analytes.
- Generates an electrical signal proportional to the sample concentration.
- Must be hot enough (20 to 30 °C above the column temperature).

# Properties of ideal detector

**The ideal detector for GC has the following characteristics:**

- Adequate sensitivity.
- Good stability and reproducibility.
- Rapidly respond to concentration changes (short response time).
- Large linear range response.
- A temperature range from room temperature to at least 400°C.
- Low sensitivity to variation in flow, pressure and temperature.
- Produces an easily handled signal.
- Stable with respect to noise and drift.
- Nondestructive of sample.

**No detector exhibits all these characteristics.**



# Flame Ionization Detector (FID)

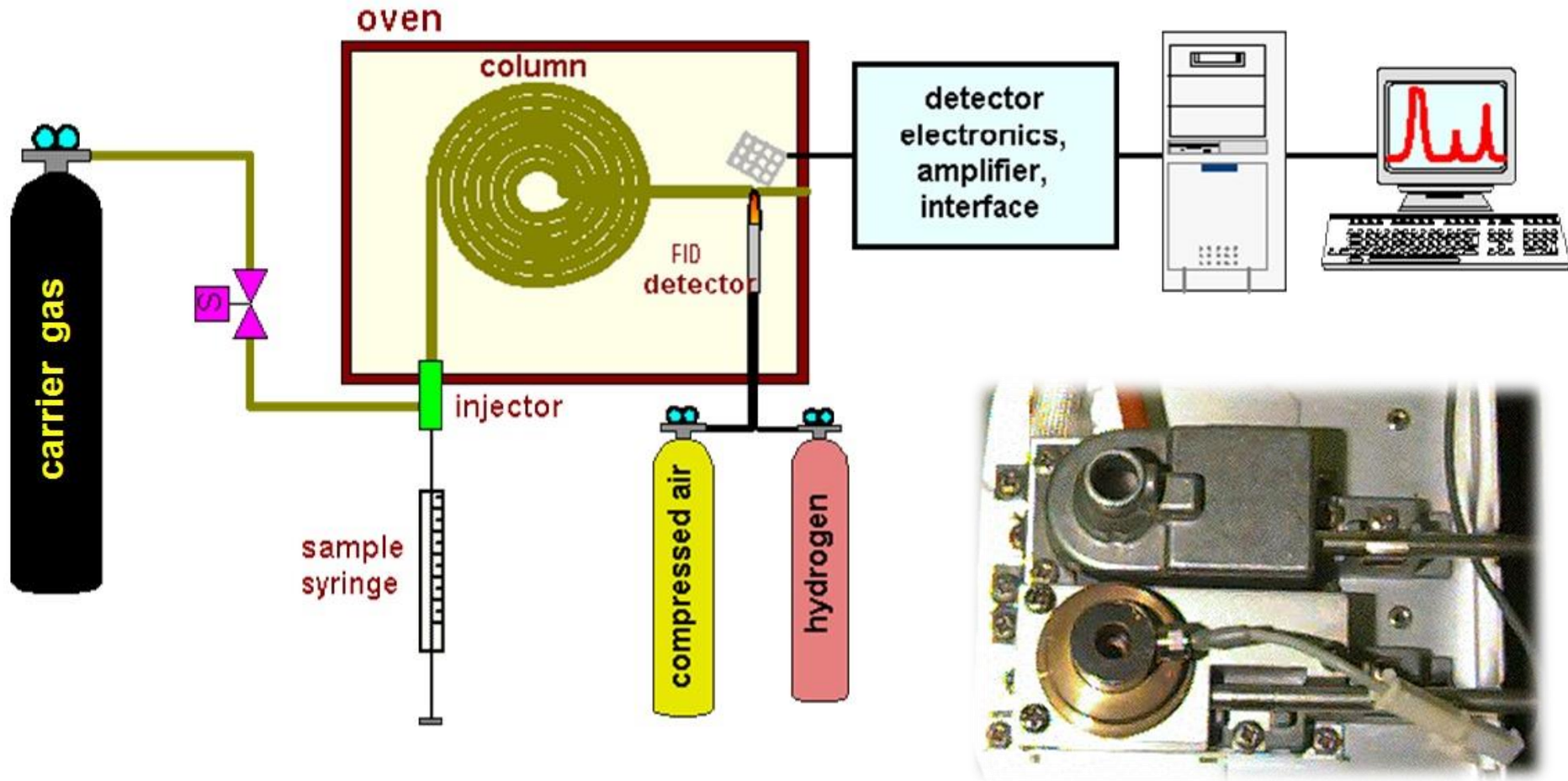

The effluent from the column is mixed with hydrogen and air, and ignited.

# Mode of detection

-Organic compounds burning in the flame produce ions and electrons (current) which can conduct electricity through the flame.

-Two electrodes are used to provide a potential difference. A large electrical potential is applied at the burner tip, and a collector electrode is located above the flame.

-The current resulting from the pyrolysis of any organic compound is measured which is proportional to the carbon content of the molecule entering.

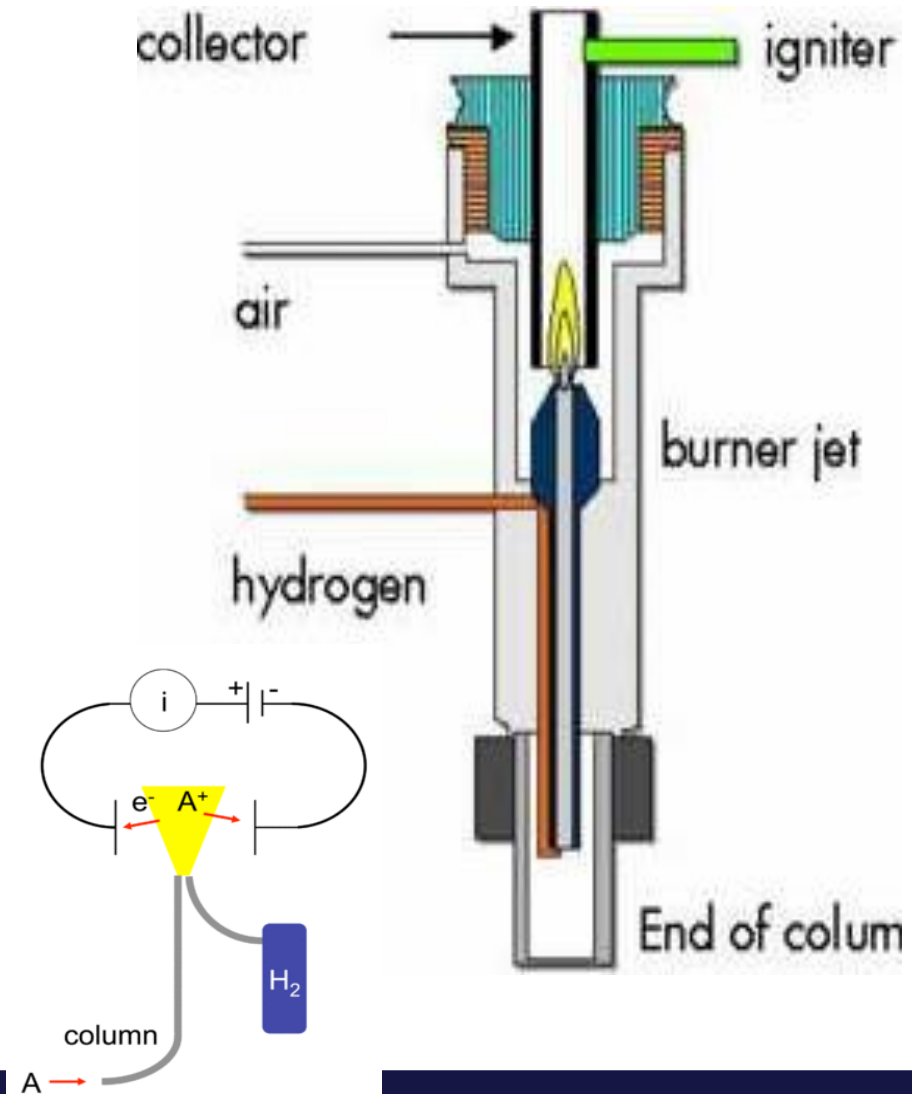

# FID response

Response is based on the number of carbon and if other elements like halogens or oxygen are present which reduce combustion.

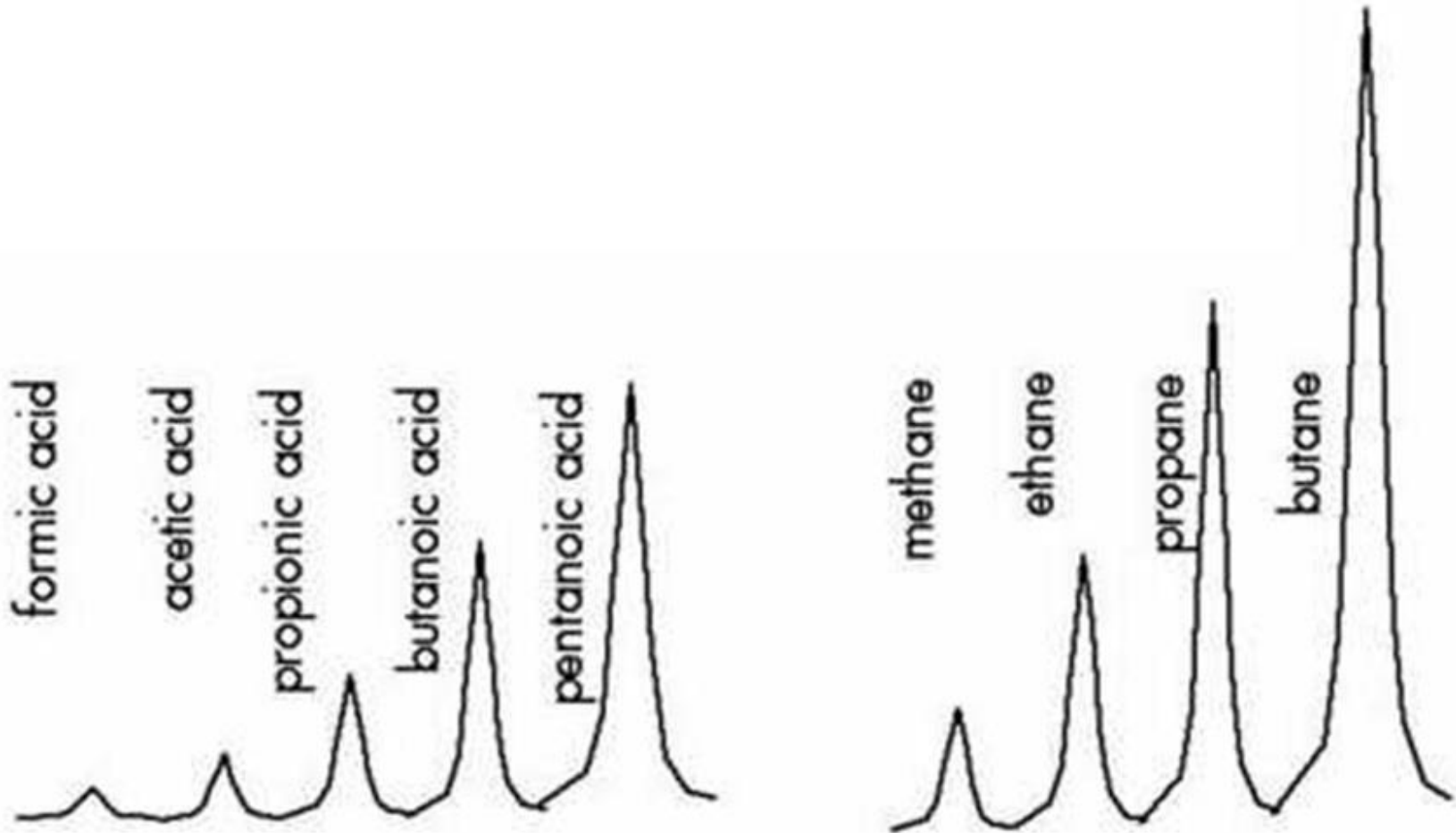

# Characteristics

- FID is a general detector for organic compounds.
- Specific, sample must be combustible (must contain **C** and **H** atoms).
- Cost: FID is relatively inexpensive to acquire and operate.
- Low maintenance requirements: Apart from cleaning or replacing the FID jet, these detectors require no maintenance.
- Has high sensitivity.
- FIDs can measure organic substance concentration at very low and very high levels (limit of detection about 5pg carbon / second).
- Large linear range response, range about  $10^7$ .
- Rugged construction: FIDs are relatively resistant to misuse.
- Low noise.
- Destructive, it destroys the sample.
- FID flame oxidizes all compounds that pass through it; all hydrocarbons and oxygenates are oxidized to carbon dioxide and water and other heteroatoms are oxidized according to thermodynamics.

# Compounds with little or no FID response

- Noble gases (**He**, ....., etc)
- **NH<sub>3</sub>**
- **NO<sub>x</sub>**
- **H<sub>2</sub>O**
- **CO<sub>2</sub>**
- **CO**
- **CS<sub>2</sub>**
- **O<sub>2</sub>**
- **N<sub>2</sub>**
- Perhalogenated compounds, CHCl<sub>3</sub>, CCl<sub>4</sub>, chlorofluorocarbon (CFCs)
- Formic acid
- Formaldehyde

In some systems, CO and CO<sub>2</sub> can be detected in the FID using a methanizer, which is a bed of Ni catalyst that reduces CO and CO<sub>2</sub> to methane, which can be in turn detected by the FID.

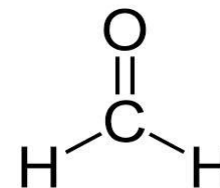
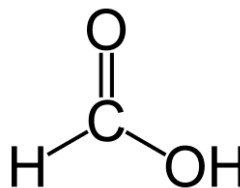
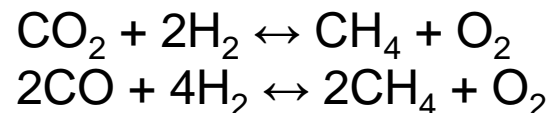

# Thermal Conductivity Detector (TCD)

The thermal conductivity detector (TCD), also known as a **Katharometer**, is a bulk property detector and a chemical specific detector commonly used in gas chromatography.

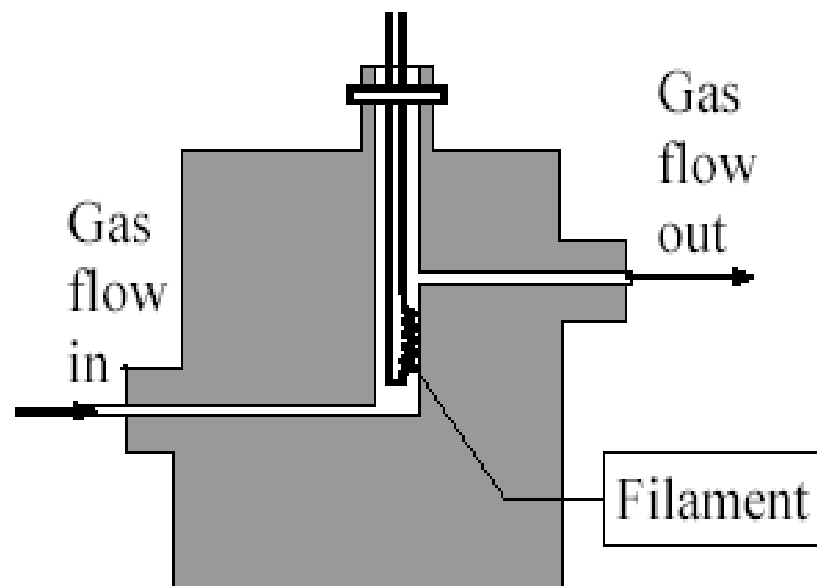

# Mode of detection

The TCD consists of an electrically heated filament in a temperature-controlled cell.

Change in resistance of a wire based on variations in the thermal conductivity of the gas evolving from a column.

This detector senses changes in the thermal conductivity of the column effluent and compares it to a reference flow of carrier gas.

Since most compounds have a thermal conductivity much less than that of the common carrier gases of He or H<sub>2</sub>, when an analyte elutes from the column the effluent thermal conductivity is reduced, and a detectable signal is produced.

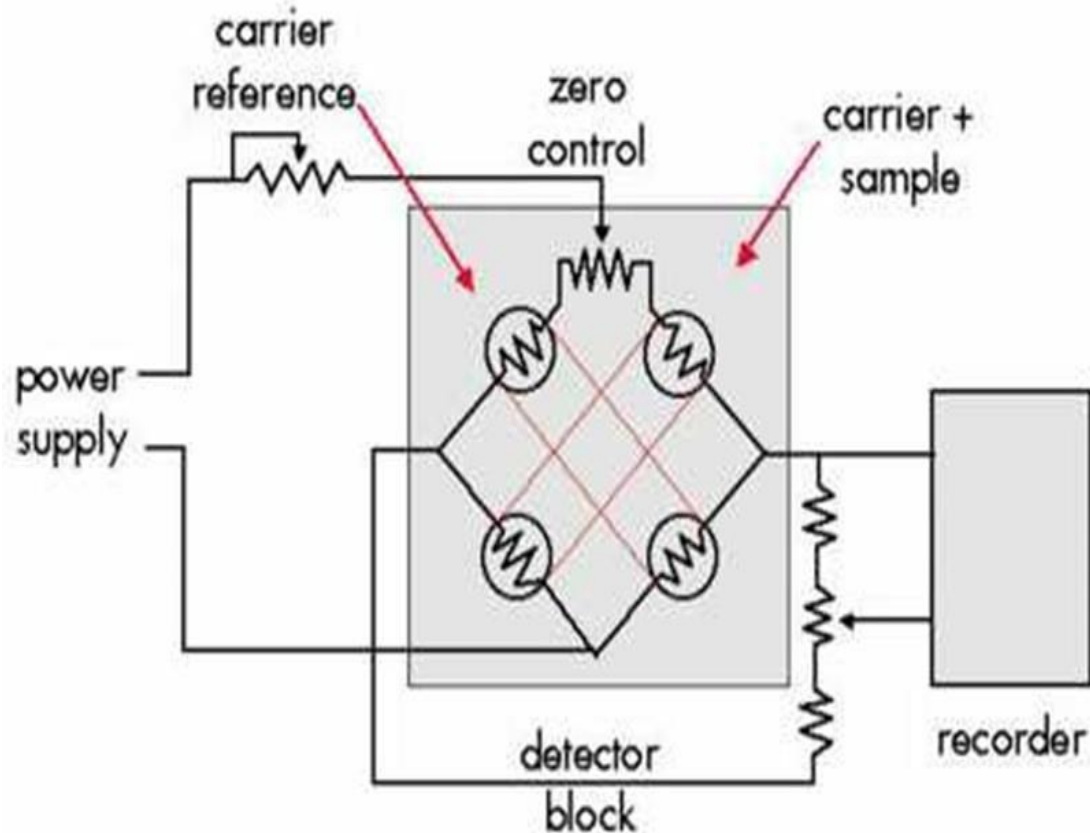

# Characteristics

- Compares the thermal conductivity of two gas flows-pure carrier gas (reference gas) and carrier gas plus components (column effluent).
- Response is universal and proportional to concentration.
- Best gases for TCD: H<sub>2</sub> or He, because of highest thermal conductivity.
- While hydrogen has the largest thermal conductivity value, He is commonly used – less reactive.
- H<sub>2</sub> will give a negative peak when He is the carrier gas.
- Nondestructive, doesn't destroy the sample.
- Limit of detection about 400pg / mL carrier.
- Linear range about 10<sup>6</sup>.



# TCD vs. FID response

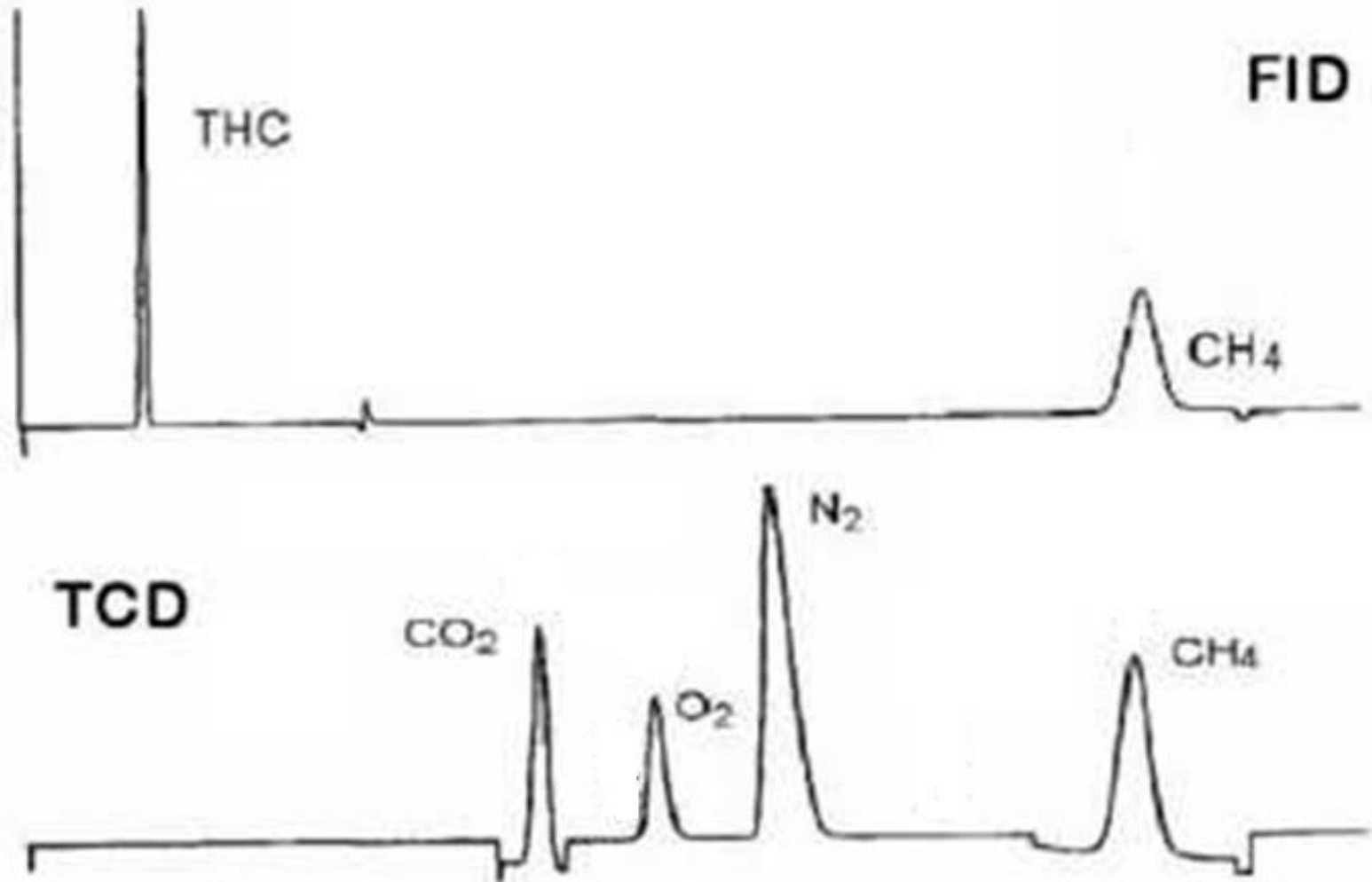

# Electron Capture Detector (ECD)

An **electron capture detector (ECD)** is a device for detecting atoms and molecules in a gas through the attachment of electrons via electron capture ionization.



# Mode of detection

The electron capture detector is used for detecting electron-absorbing components (high electronegativity) in the output stream of a gas chromatograph.

The ECD uses a radioactive beta particle (electron) emitter in conjunction with a so-called makeup gas flowing through the detector chamber ( $^{63}\text{Ni}$ ).

Usually,  $\text{N}_2$  is used as makeup gas, because it exhibits a low excitation energy, so it is easy to remove an electron from a nitrogen molecule.

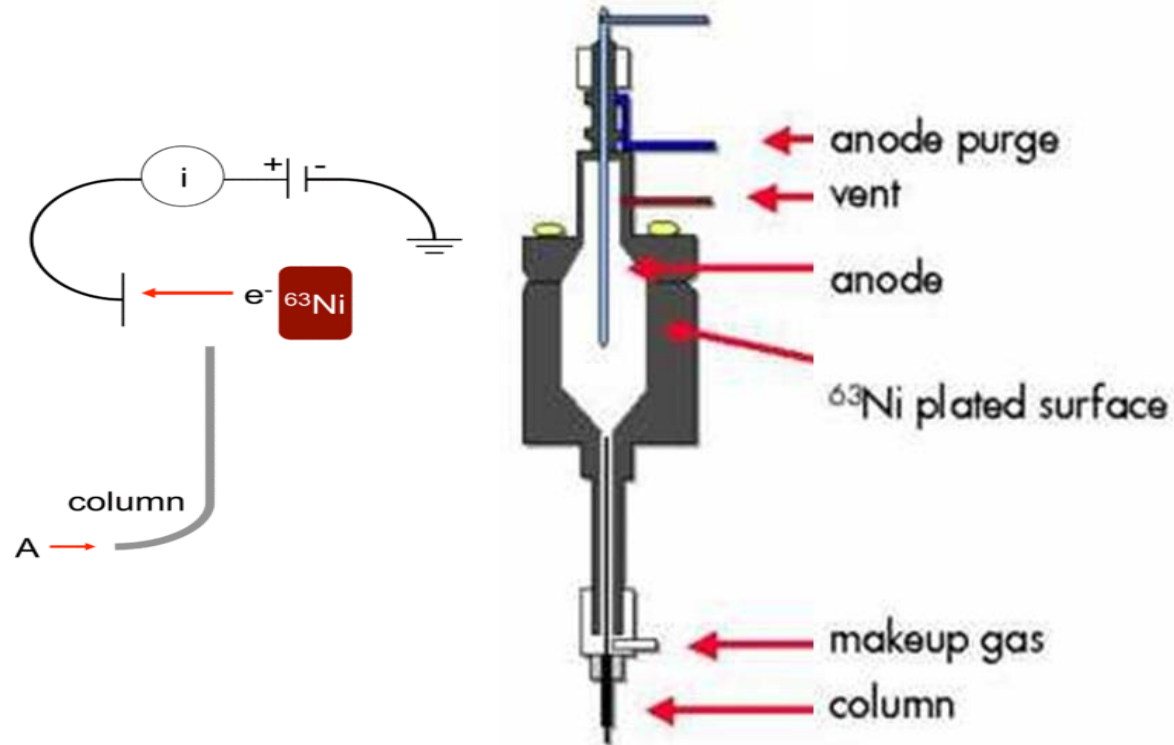

The electrons emitted from the electron emitter collide with the molecules of the makeup gas, resulting in many more free electrons. The electrons are accelerated towards a positively charged anode, generating a current.

# Characteristics

- Depend on the absorption of beta particles (electrons) by species containing Electrophores, reducing the current.
- Specific – sample must contain a gas phase electrophore.
- ECD detectors are particularly sensitive to halogens, organometallic, nitriles, or nitro and conjugated double bonds compounds.
- Nondestructive.
- Limit of detection about 0.1pg Cl / second.
- Linear range about  $10^4$ .
- Provides excellent trace analysis for halogenated compounds such as pesticides and CFCs, even at levels of only one part per trillion (ppt), thus revolutionizing our understanding of the atmosphere and pollutants.
- Major problem – detector is radioactive.

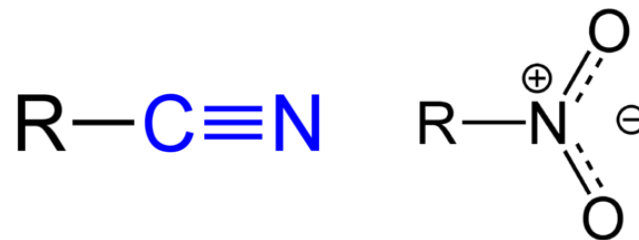

# ECD relative responses

$10^0$	hydrocabons
$10^1$	esters, ethers
$10^2$	alcohols, ketones, monochlorides, amines
$10^3$	monobromides, dichlorides
$10^4$	anhydrides, trichlorides
$10^5 -$	poly halogenated, mono and diiodo
$10^6$	

# Nitrogen-Phosphorous Detector (NPD)

The **nitrogen–phosphorus detector (NPD)** or **thermionic specific detector (TSD)** or **thermionic detector (TID)** is a type of detector commonly used with gas chromatography

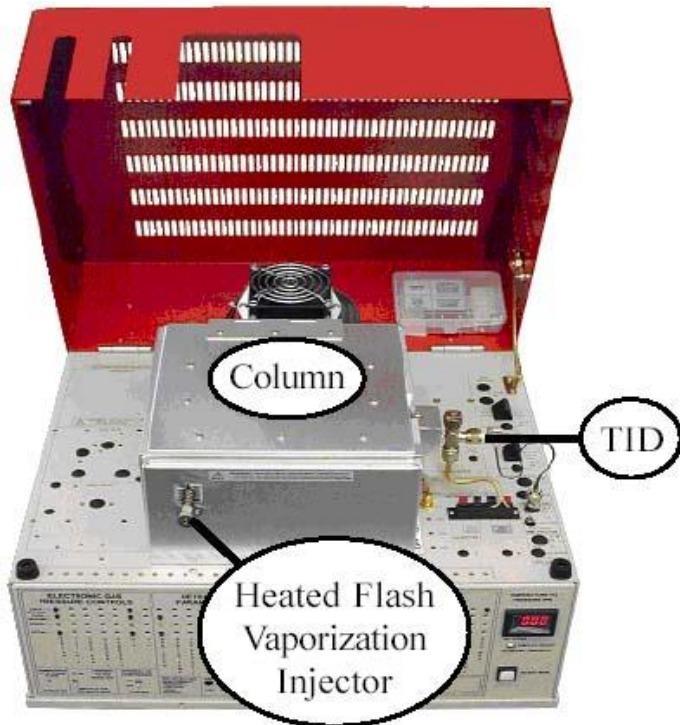

# Mode of detection

Similar in structure to FID (essentially a modified FID). The column effluent is mixed with  $H_2$ , passes through the flame tip, a rubidium or cesium bead, which is mounted over the nozzle, ignites the hydrogen (by acting catalytically), and forms a cold plasma (having a temperature of 600-800°C).

This temperature tends to produce a large number of ions from P or N containing molecules. The output current is proportional to the number of ions collected. It is sensed by an electrometer, converted to digital form, and sent to an output device.

A concentration of hydrogen gas is used such that it is just below the minimum required for ignition. The low hydrogen/air ratio cannot sustain a flame, minimizing hydrocarbon ionization, while the alkali ions on the bead surface facilitate ionization of N- or P-organic compounds.

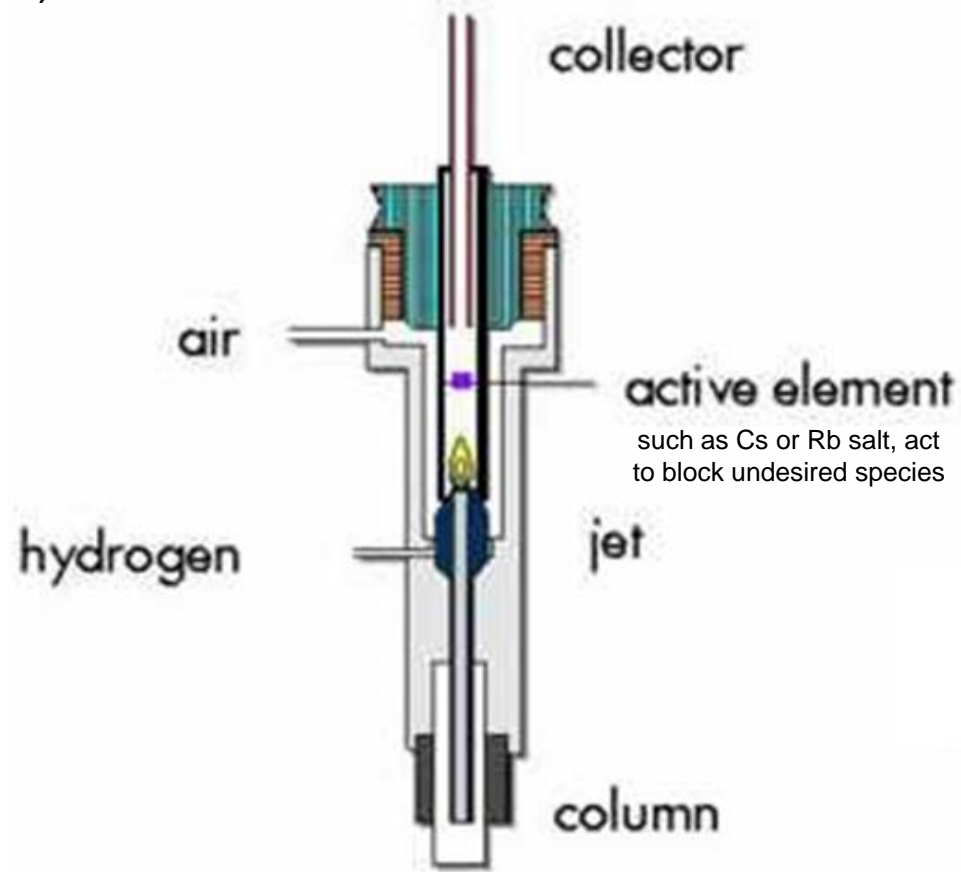

# Characteristics

- Specific – compounds must contain nitrogen or phosphorous.
- Destructive.
- Its response to P atom is approximately 10 times greater than to a N atom and  $10^4$  larger than a C atom.
- Limit of detection about 0.4 pg N / second.  
about 0.2 pg P / second.
- Linear range about  $10^4$ .
- Compared with the FID, TID is approximately 500 times more sensitive for compounds containing P and 50 times more sensitive for N compounds.
- Useful for detecting many pesticides and azo-compounds.



# Hyphenated GC methods

- **GC** can be attached to a second instrument that will produce qualitative and/or quantitative data.
- The combination of a chromatographic and spectral method.
- Exploit advantage of each method.
- Chromatograph - produce pure fraction from your sample.
- Spectral method - yield qualitative information about a pure component.

**e.g.,**

- (1) **Mass spectrometry (GC-MS)**
- (2) **Infrared spectrometry (GC-FTIR)**
- (3) **Nuclear magnetic resonance (GC-NMR)**
- (4) **Atomic absorption spectroscopy (GC-AAS)**
- (5) **Atomic emission spectroscopy (GC-AES)**
- (6) **Inductively coupled plasma - mass spectrometry (GC-ICP-MS)**

# Mass Spectrometry (GC-MS)

- Synergistic combination of two powerful analytic techniques.
- The gas chromatography separates the components of a mixture in time.
- The mass spectrometer provides information that aids in the structural identification of each component.
- Uses the difference in mass-to-charge ratio ( $m/e$ ) of ionized atoms or molecules to separate them from each other.

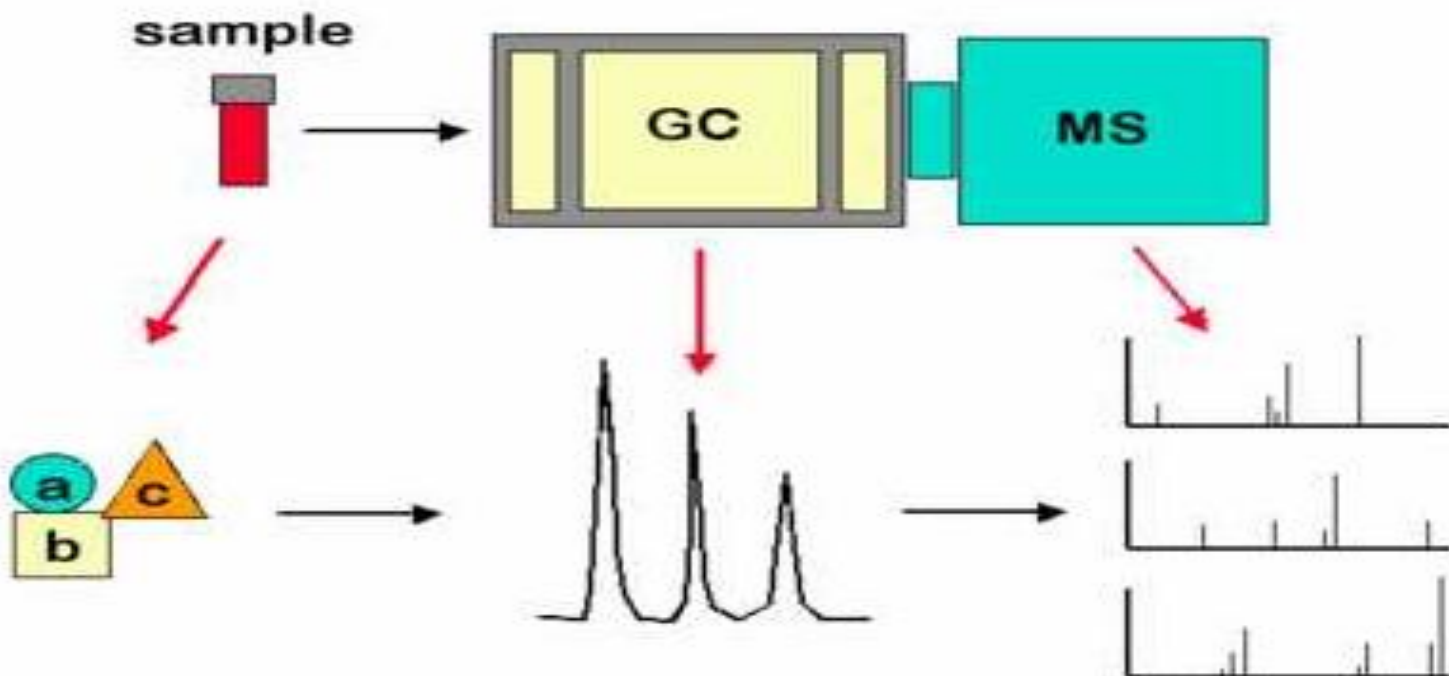

## The general operation of a mass spectrometer is:

- Result of the GC goes through an ionizer where it is bombarded by a high energy electron beam.
- This beam breaks the complex molecules into a standard set of fragments.
- The ionized samples then go through magnetic field which deflects ion according to mass to charge ratio.
- A detector picks up the fragments of a certain mass.
- Each peak of a chromatogram becomes a “fingerprint” of the compound.
- The fingerprints are compared with a library to identify the compounds.

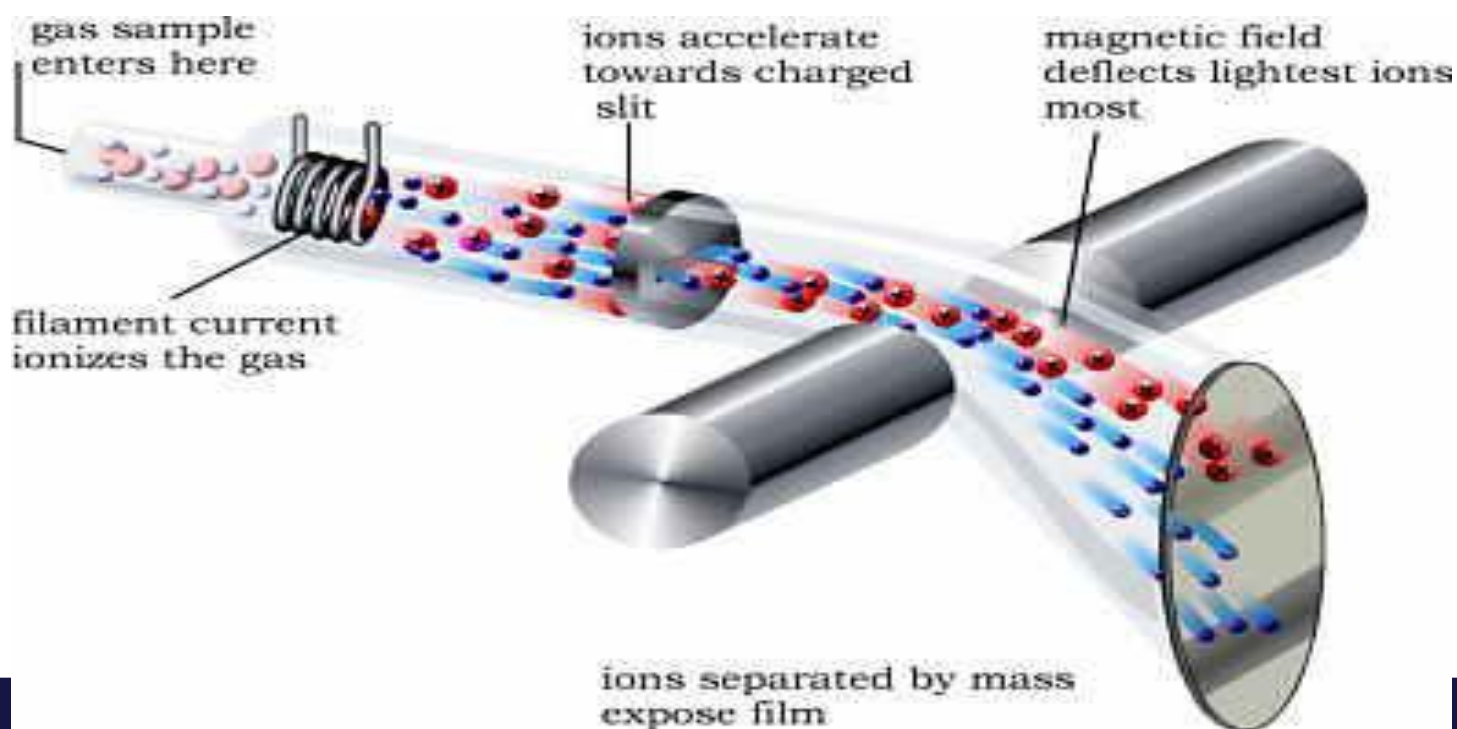

# Infrared Spectrometry (GC-FTIR)

- GC with IR can enable the separation and identifying the compounds.
- Gas Chromatograph partitions the sample as it passes through the column.
- Is especially useful for qualitative analysis of functional groups and other structural features.
- Very sensitive.
- Very expensive.

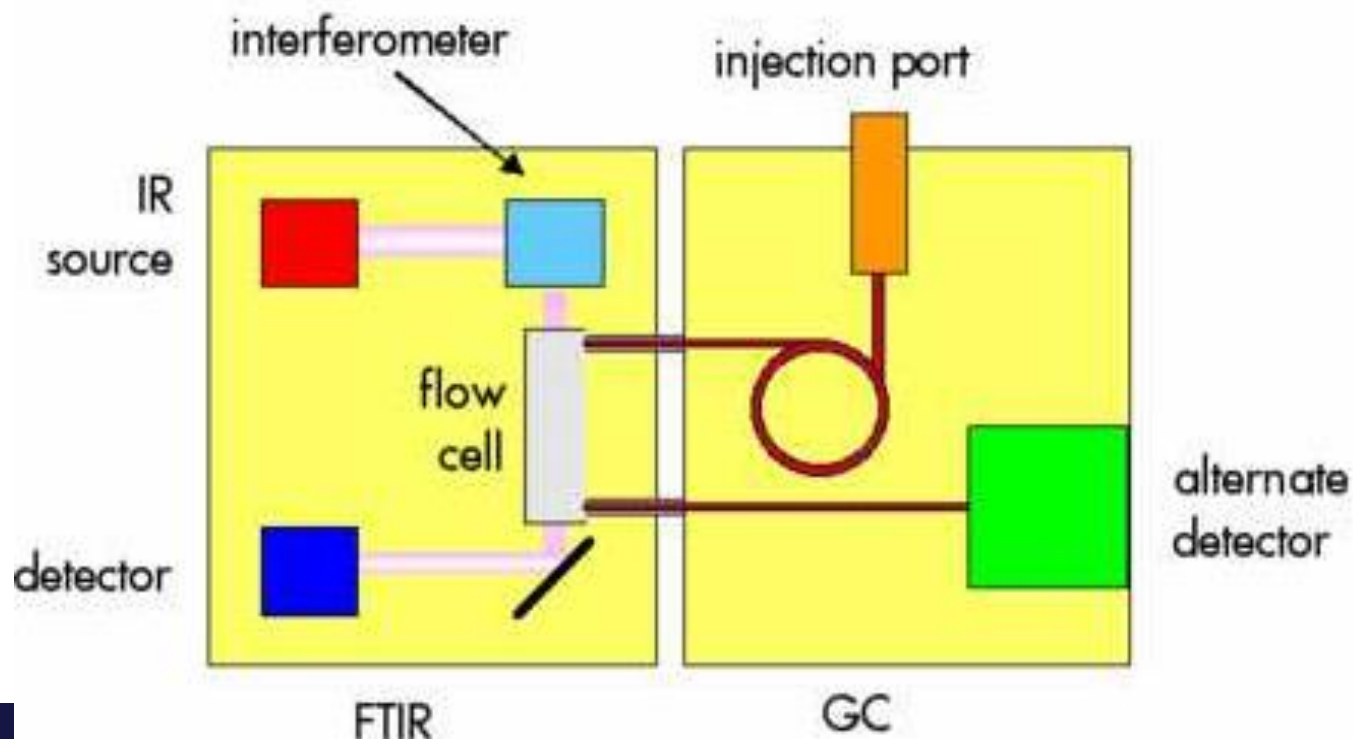

## Gas Chromatographic Detectors

Type	Applicable Samples	Typical Detection Limit
Flame ionization	Hydrocarbons	0.2 pg/s
Thermal conductivity	Universal detector	500 pg/mL
Electron capture	Halogenated compounds	5 fg/s
Mass spectrometer	Tunable for any species	0.25–100 pg
Thermionic	Nitrogen and phosphorous compounds	0.1 pg/s (P) 1 pg/s (N)
Electrolytic conductivity (Hall)	Compounds containing halogens, sulfur, or nitrogen	0.5 pg Cl/s 2 pg S/s 4 pg N/s
Photoionization	Compounds ionized by UV radiation	2 pg C/s
Fourier transform IR	Organic compounds	0.2 to 40 ng

# GC detectors sensitivities and ranges

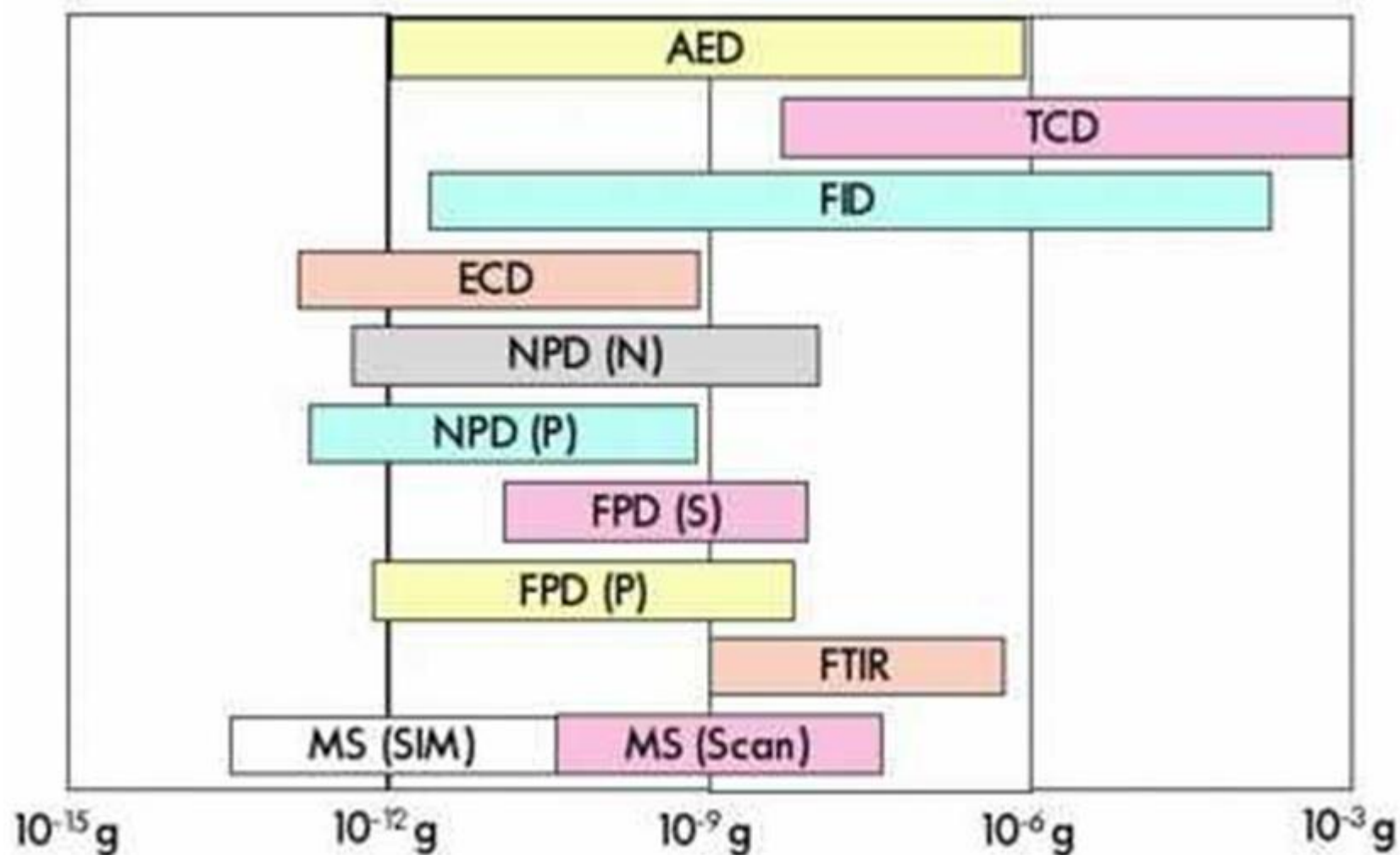

# Factors influencing the GC separation

## The major interrelated factors to consider

- Column length
- Column internal diameter
- Film thickness (for open tubular columns)
- Carrier gas type
- Carrier gas velocity
- Column temperature
- Type of detector

