

Chem 458

Gas Chromatography

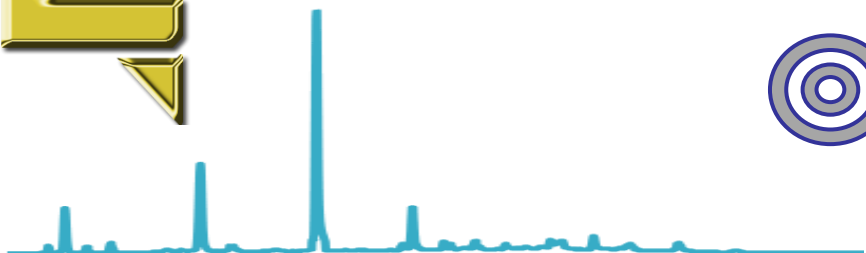
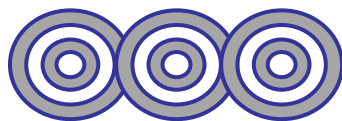

Ahmad Aqel Ifseisi

Associate Professor of Analytical Chemistry
College of Science, Department of Chemistry
King Saud University

P.O. Box 2455 Riyadh 11451 Saudi Arabia

Building: 05, Office: 2A149, Lab: 2A127

Tel. 014674198, Fax: 014675992

Web site: <http://fac.ksu.edu.sa/aifseisi>

E-mail: ahmad3qel@gmail.com

aifseisi@ksu.edu.sa



Gas Chromatography: An Overview

Gas chromatography (**GC**) is a common type of chromatography in which the mobile phase is **gas** used in analytical chemistry for separating and analyzing compounds that can be vaporized without decomposition.

Separation by

- Partition** between gaseous mobile phase and liquid stationary phase supported by inert packing (**GLC**).
- Adsorption** between gaseous mobile phase and solid stationary phase (**GSC**).

Gas Chromatography Analysis

In GC, the sample is **vaporized** and **injected** onto the head of a chromatographic column.

Elution is brought about by the flow of an **inert gaseous** mobile phase, the mobile phase does not interact with molecules of the analyte (i.e., carrier gas); its only function is to transport the analyte through the column.

After separation, the compounds are respectively detecting using suitable detectors.

Vaporization



Injection



Elution



Separation



Detection



Petroleum Refinery

Separation depends on **temperature**.
Based on a wide range of **boiling points** and **polarity**.

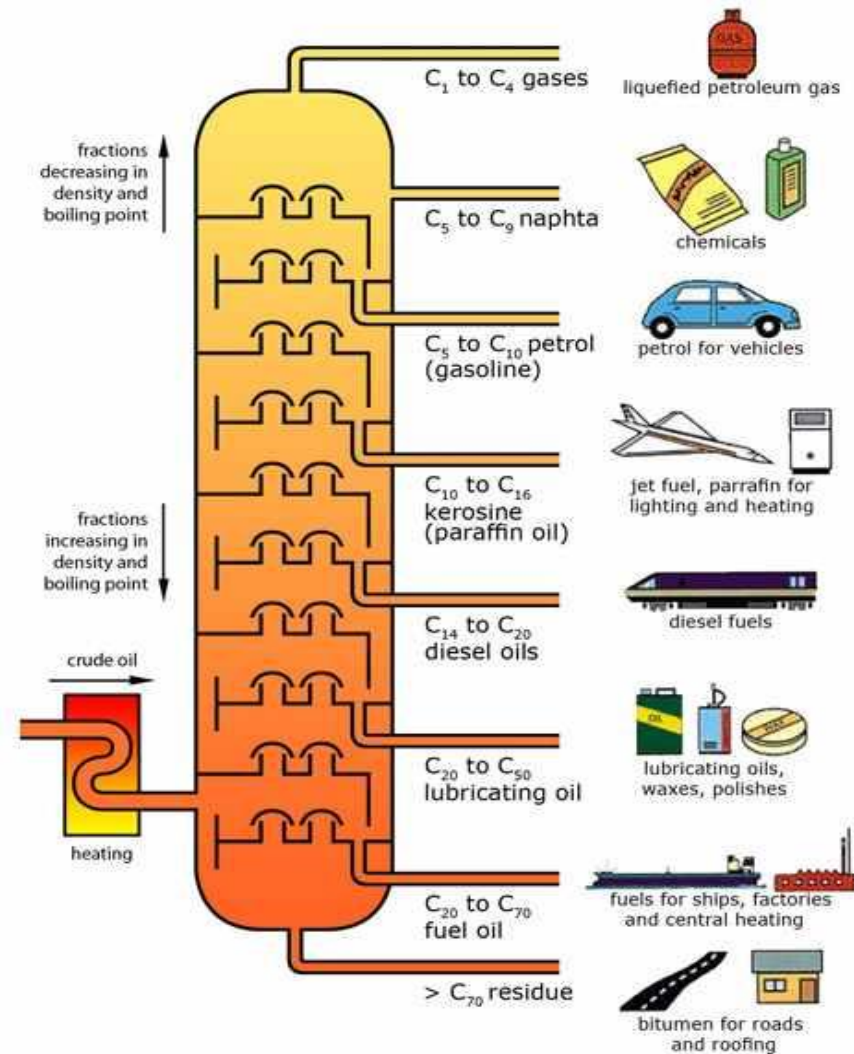

Fractional Distillation

GC used for **volatile** and **non degradable** compounds by temperature.

Occasionally, it is also possible to **derivatize** (chemically modify) non-volatile and heat degradable target chemicals prior to analysis.

Derivatization in GC is the process of chemically modifying a compound to produce a new compound which has properties that are suitable for analysis using a GC. Bulky and nonpolar groups are often used for this purposes.

What does derivatization accomplish?

- Increases volatility.
- Increases stability.
- Increases detectability.
- Enhances sensitivity for detection.

Main types of derivatization

Silylation

-Replaces active hydrogens (from alcohol) with e.g. TMS (trimethylsilyl group). Readily volatilizes the sample. Most prevalent method.

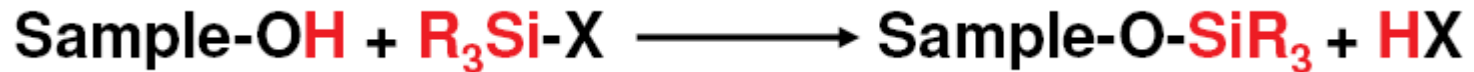

Alkylation

-Reduces molecular polarity by replacing active hydrogens with an alkyl group.

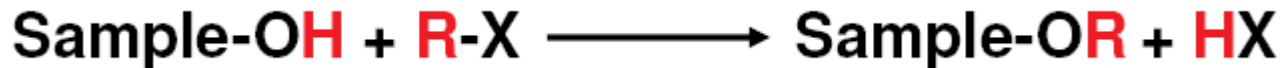

Acylation

-Reduces the polarity of amino, hydroxyl and thiol groups and adds halogenated functionalities to enhance the sensitivity for GC detectors such as electron capture detector (ECD).

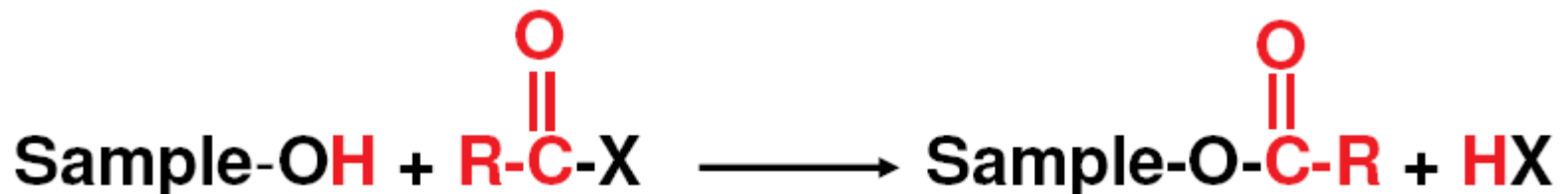

General silylation reaction

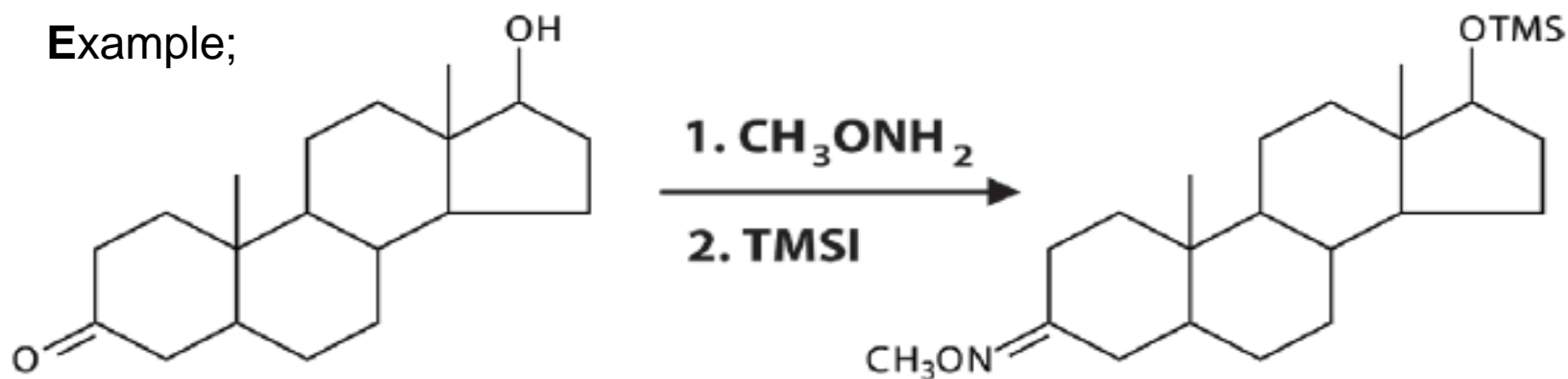
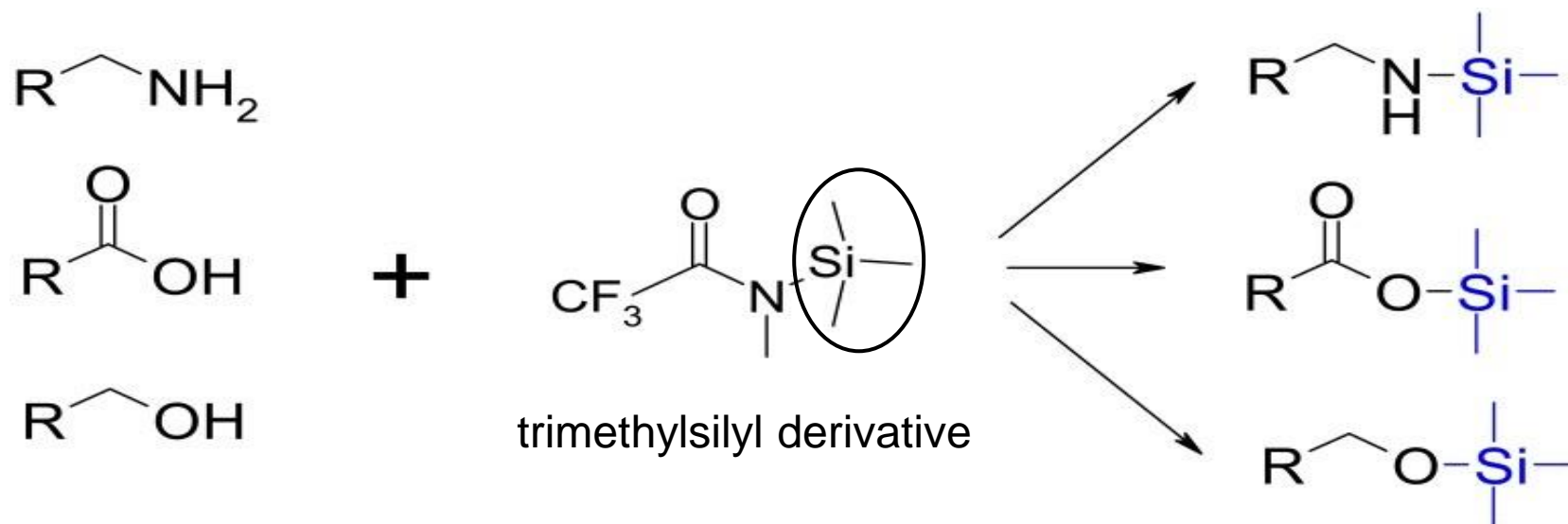

Derivatization reaction of androsterone using TMSI/methoxyamine.

GC Physical Components

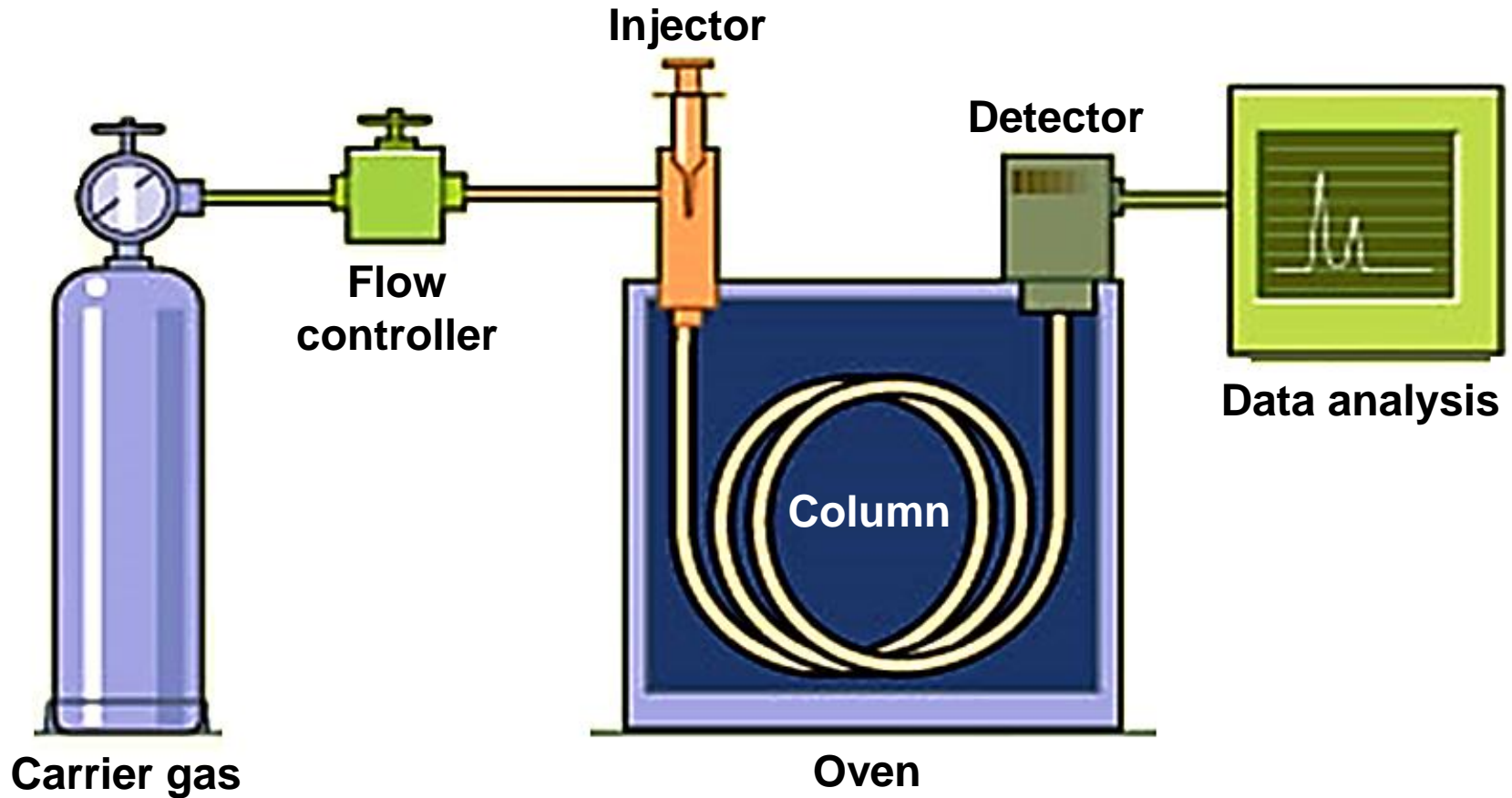
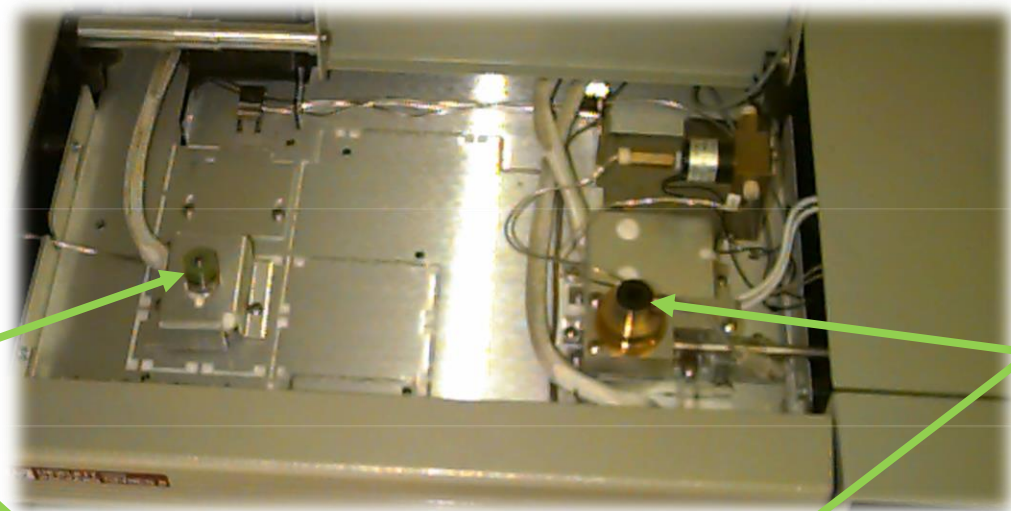

Diagram of a GC

Top & front views of gas chromatograph

Top view



injection port

flame ionization detector



column

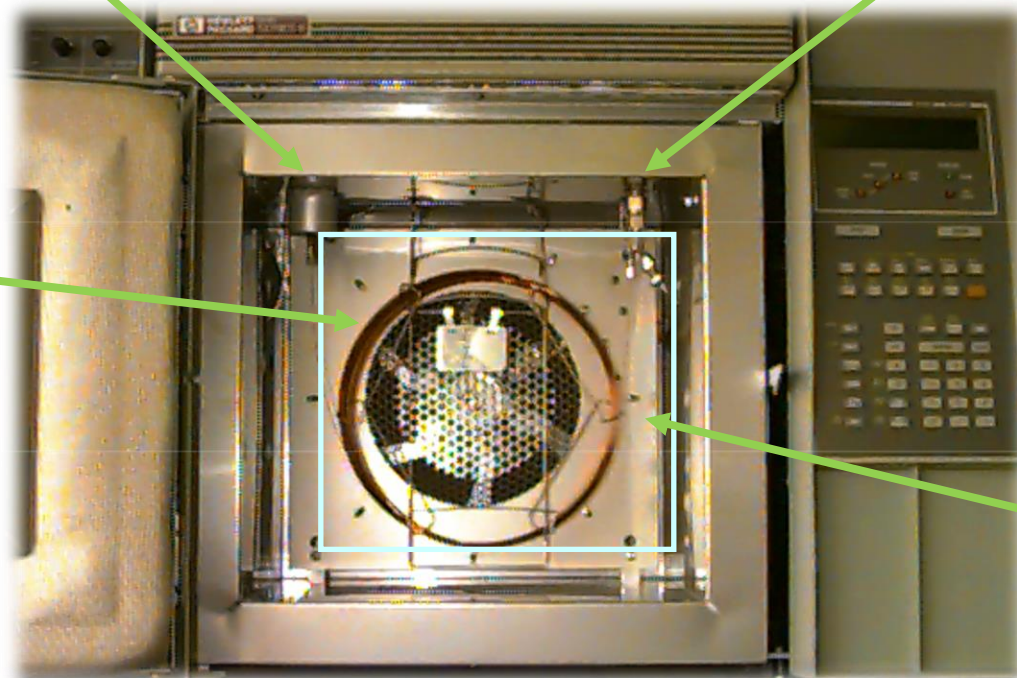

oven

Front view

Carrier Gas

- Chemically inert gases (He, H₂, N₂ & CO₂)
- High purity, 99.9995% pure or better
- Free from water and oxygen
- Detector compatibility
- Economic / safety reasons
- Efficiency / speed
- Gas filter used to eliminate impurities such as: water, oxygen and hydrocarbons

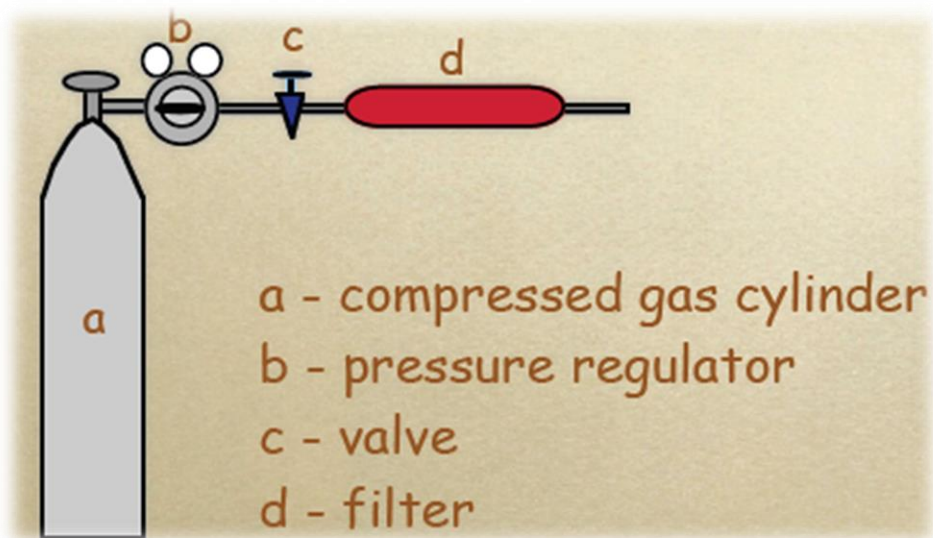

H₂: efficient, cheap and rapid but not safe.

N₂: cheap and safe but less efficient and not inert.

He: efficient, rapid, inert and safe but relatively expensive.

Carrier gas supply

Pressure regulators:

- Reduce pressure of gas
- Control the flow rate



double stage pressure regulator

Flow meters



$$\text{Flow rate} = \frac{\text{volume (mL) between marks}}{\text{transverse time (min)}}$$



soap bubble flow meter



- Electronic pressure control or electronic flow meter
- Constant flow
- Constant pressure



rotameter

Injector

Role of injectors

- Works as an inlet for the sample.
- It vaporizes and mix the sample with the carrier gas before the sample enters the head of the column.

The injection volume has a great effect on the quality of the separation.

The type of column used in the analysis sets the mode of injection.

Direct vaporization injector

For packed columns

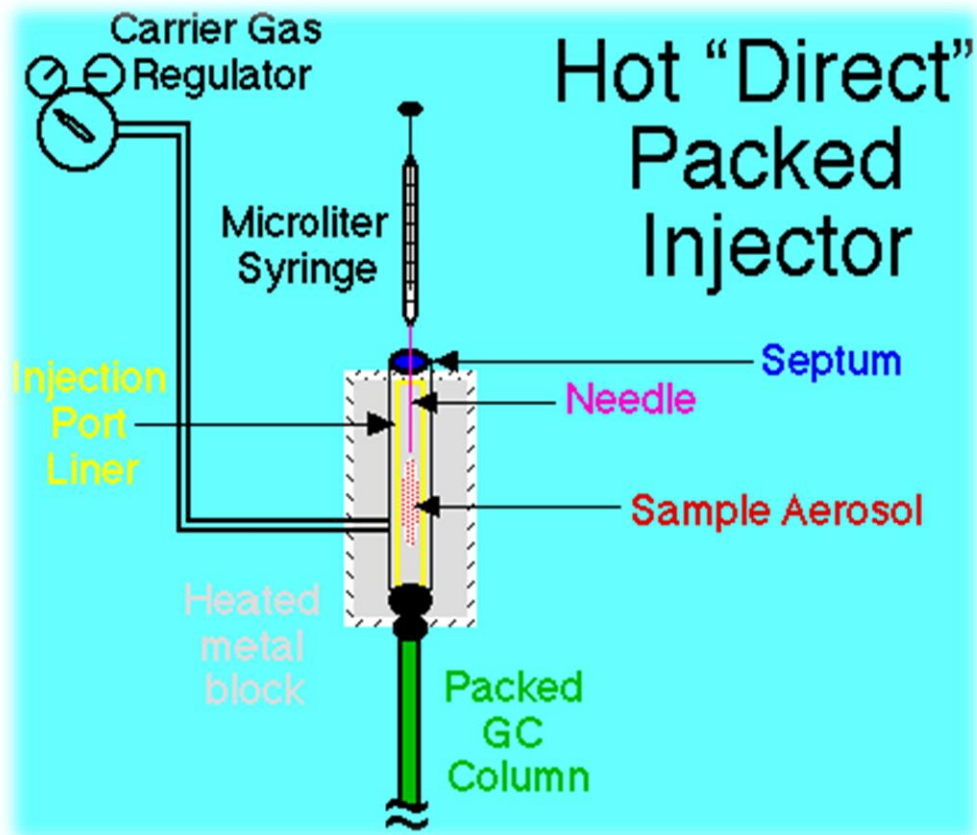
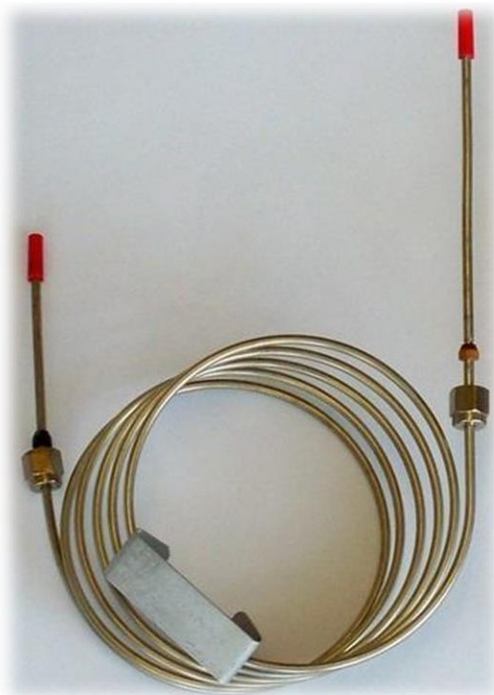

Split / Splitless injector

For capillary columns

-Operate in two modes, with or without flow splitting.

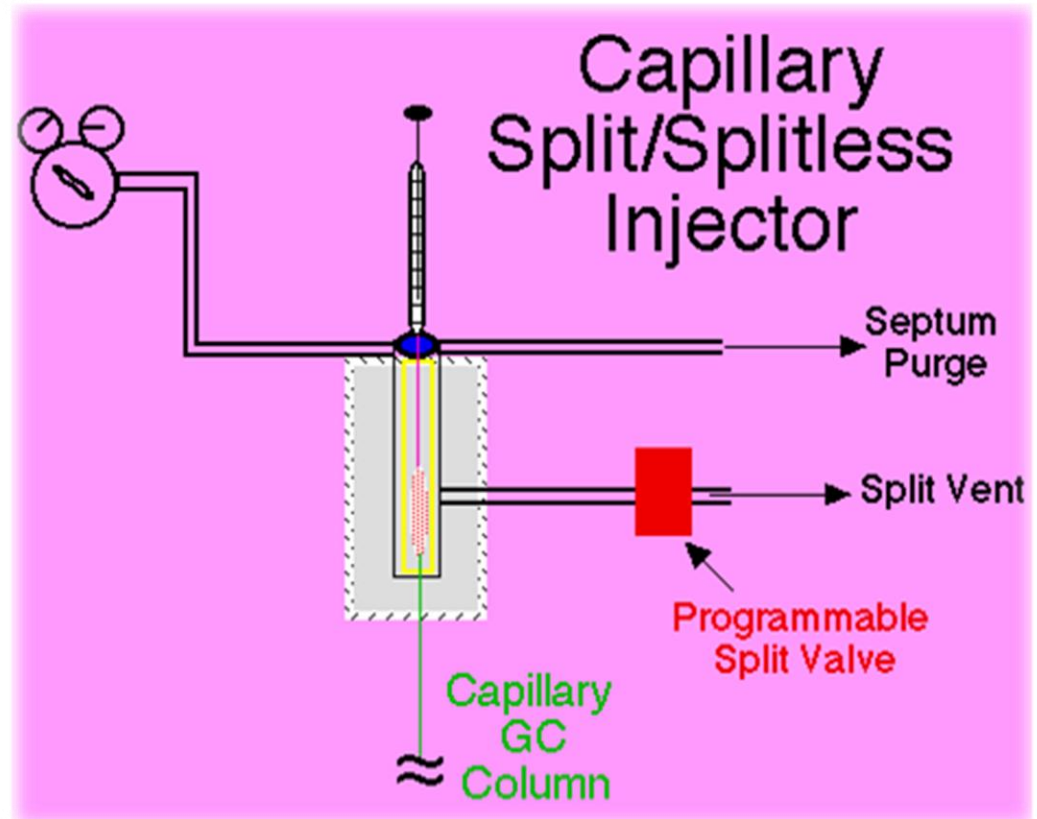

Split mode

- Carrier gas arrives in the vaporization chamber with a relatively large flow.
- A vent valve separates the carrier gas flow into two parts of which the smallest enters the column.
- The split ratio varies between 1:10 and 1:500.

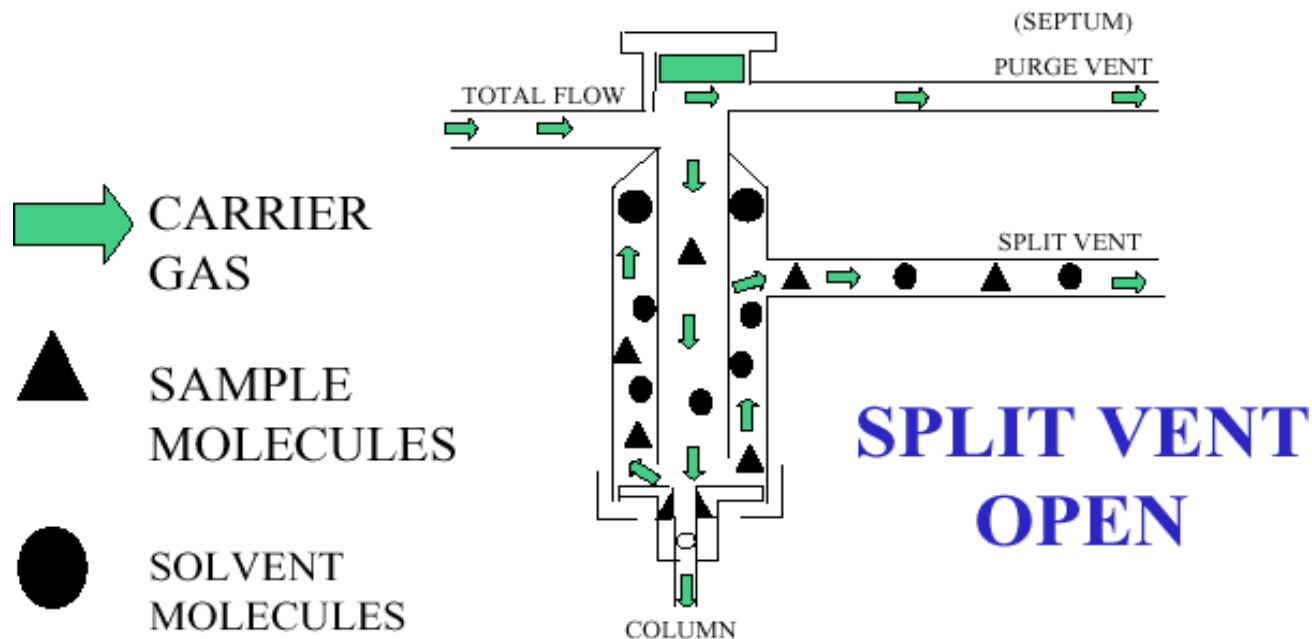

Splitless mode

- All sample to column.
- Best for quantitative analysis.
- For trace analysis.

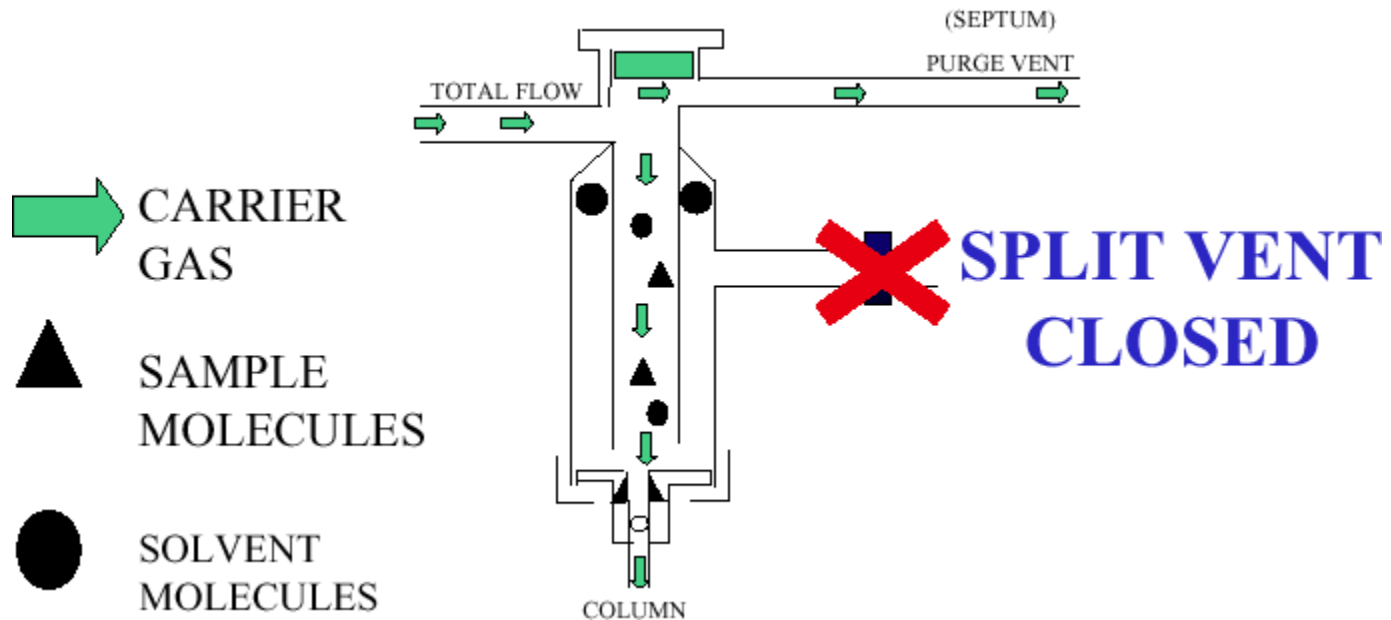

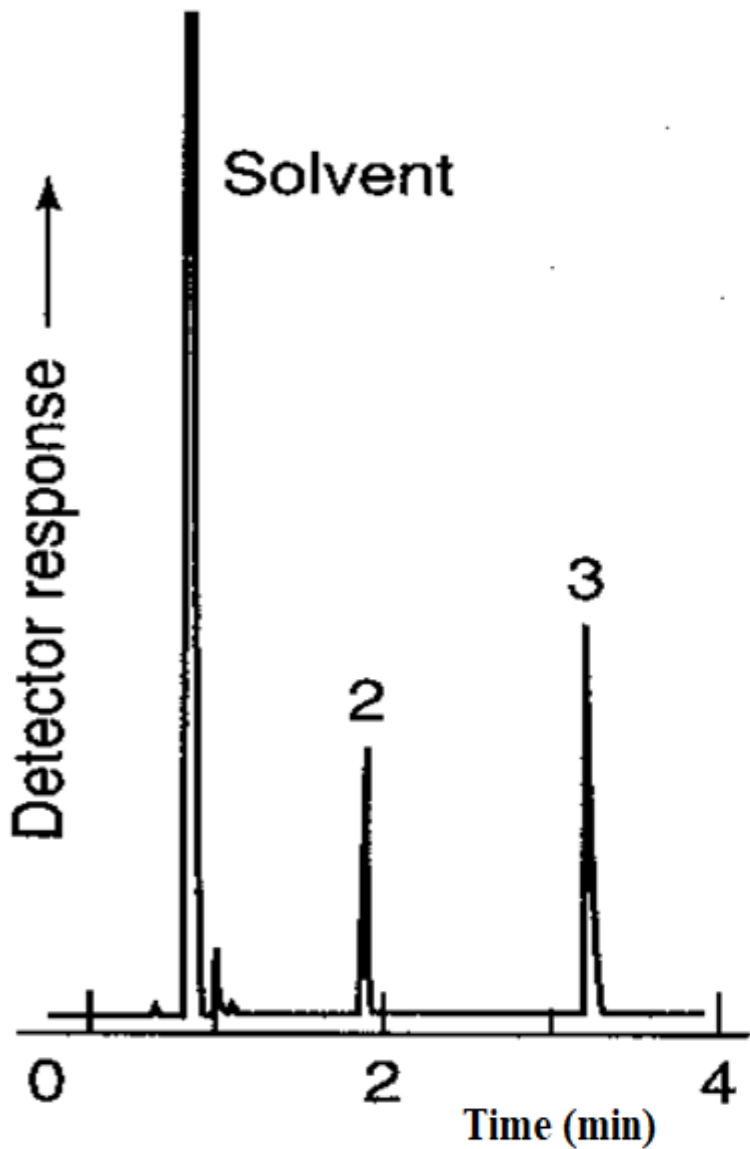

Split mode injection

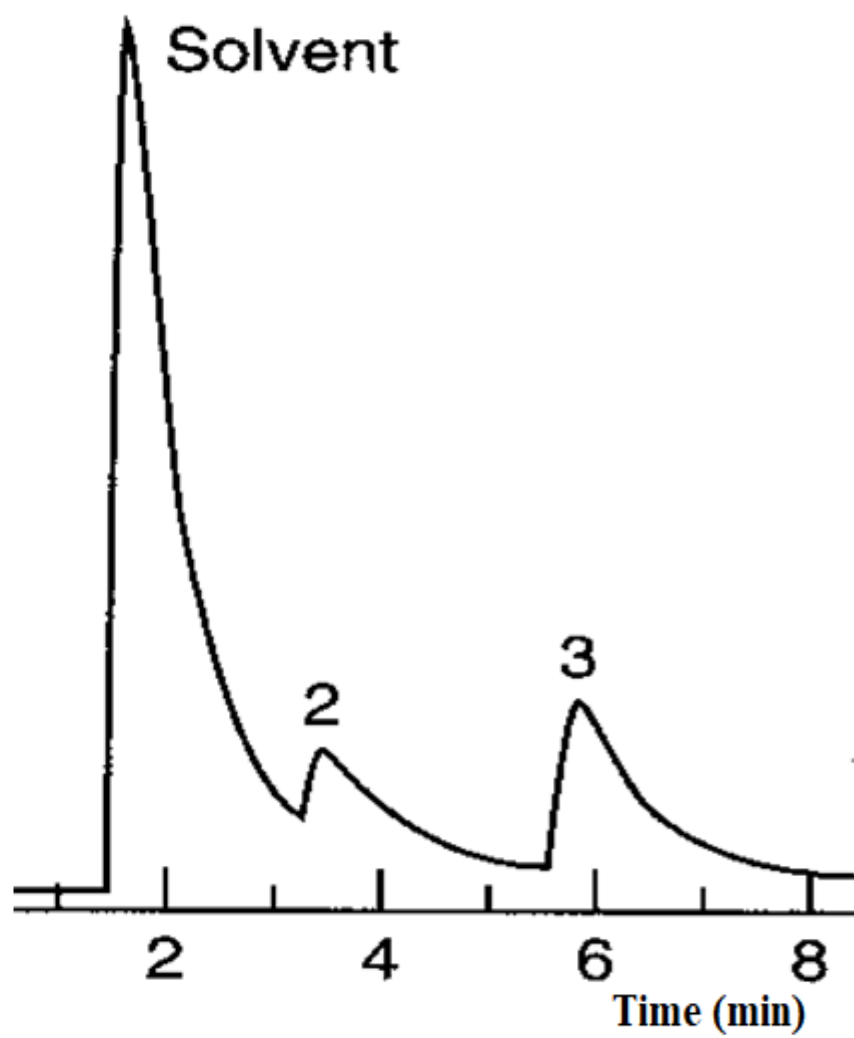

Splitless mode injection

Sample injection

It allows a rapid and simple introduction of the sample to be analysed in the gas chromatograph.

There are two main injection systems, depending on the nature of sample:

-Injection port: for introduction of liquids and solutions.

-Sampling loop injection: for introduction of gas samples.

Injection port

For rapid introduction and volatilisation of the liquid and solution samples.

-Injection port temperature must be high enough to quickly evaporate the sample without thermal degradation.

-The injection temperature is 20° higher than the boiling point of the less volatile constituent of the mixture.

-To avoid condensation of the sample in the injection port, the injector temperature must be higher than column temperature:

$$T_{\text{injector}} > T_{\text{column}} \text{ (about } 50^{\circ}\text{C)}$$

-The volume of the injection port must allow the volatilisation of the liquid sample and avoid the excessive dead volume.

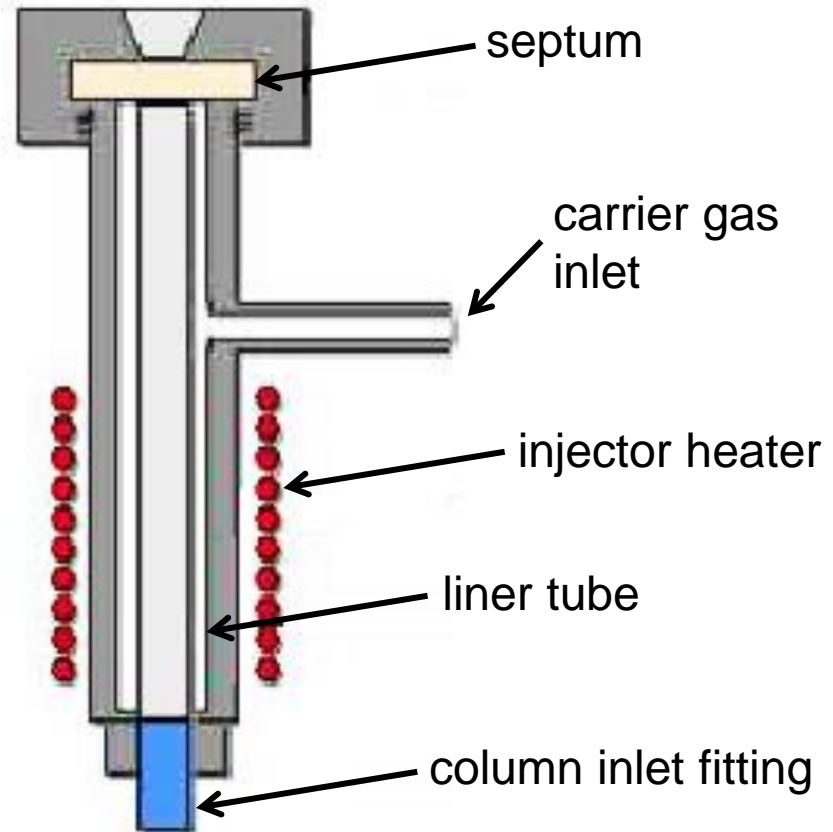

Injection techniques

Bad injection techniques are one of the major sources of errors in gas chromatography, both qualitatively and quantitatively.

If an automatic injector (auto-injector or auto-sampler) is available, it is better than manual injection

- Syringe injection.
- Gas sampling loop/valve.
- Purge and trap.
- Solid phase microextraction (**SPME**).

Syringe injection

The syringe used to introduce an accurate volume of the liquid or gas sample in the injector.

Several syringe models are available: from 1 mL to several millilitres, with various options: fixed or removable needle, adaptor, sharp or round needle.



Microsyringe

Injection volume:

- Liquids 0.1–10 μL (typical).
- Gases 0.5–5 mL (typical).



Adaptor, can be used to help control the injected volume

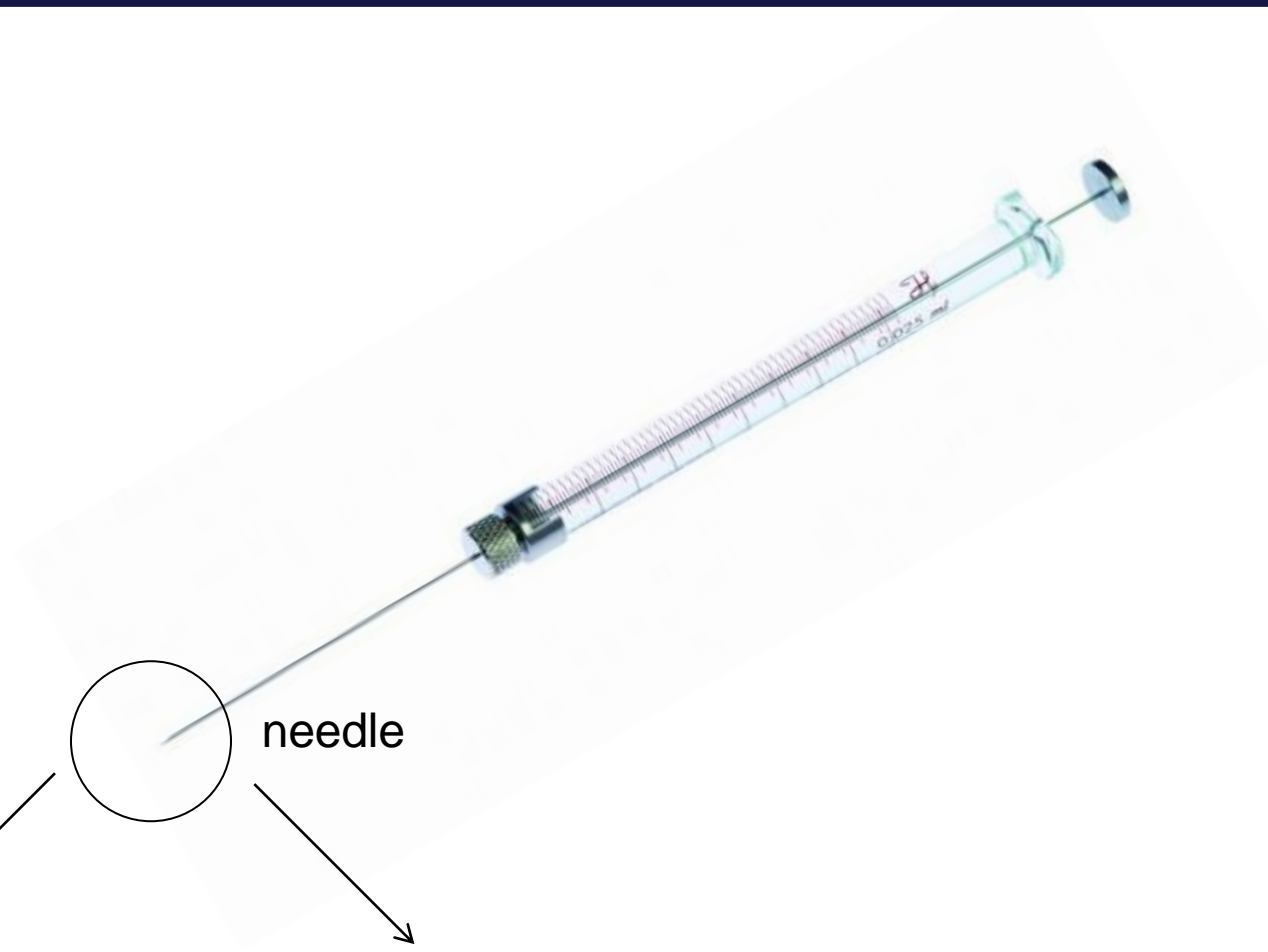
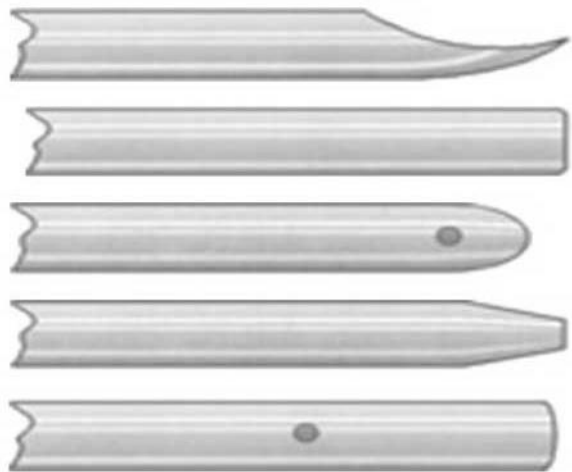

needle

Bevel

Blunt



Oven

Column temperature is an important variable that must be controlled for precise work, so the column is ordinarily housed in a thermostated oven.

The optimum column temperature depends upon the **boiling point** of the sample and the degree of separation required.

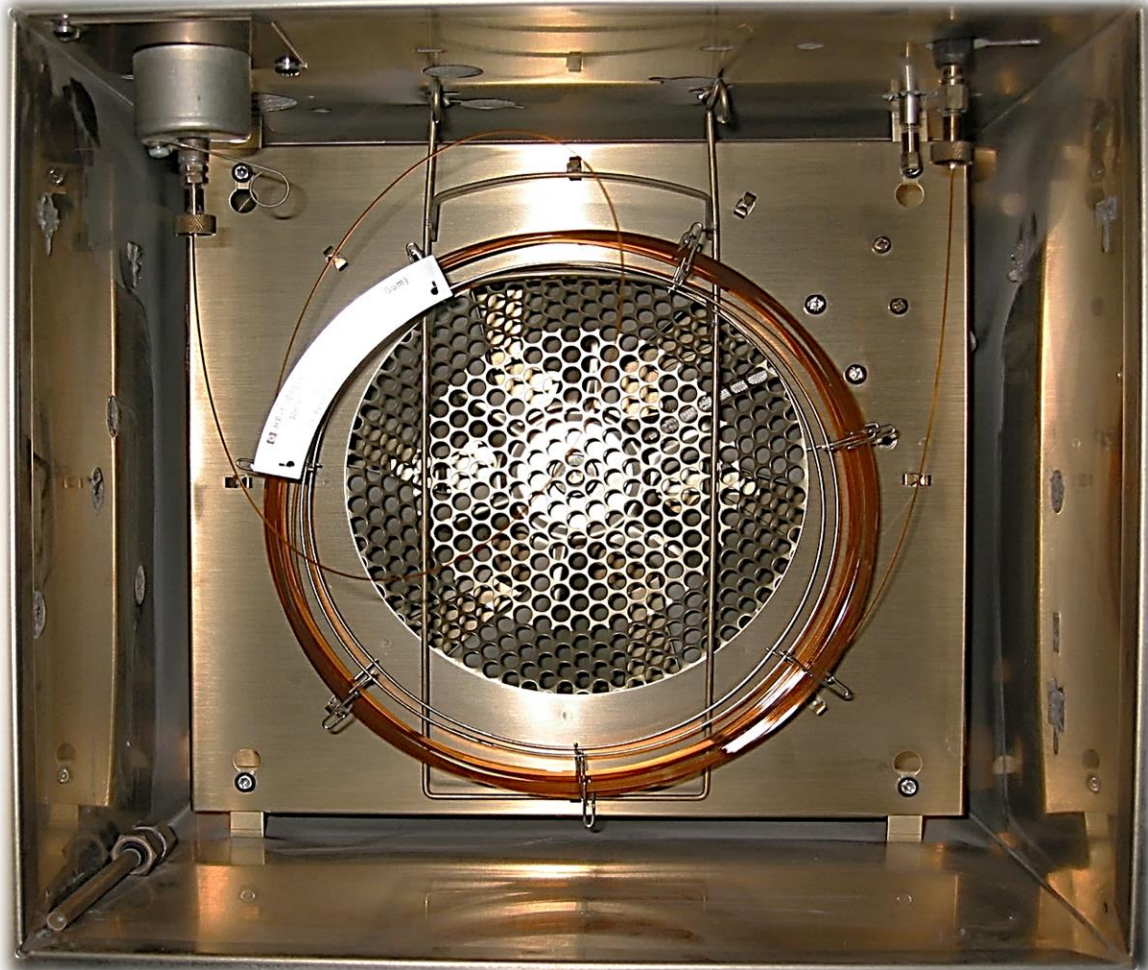

Temperature control

↓

Isothermal

150 °C

A horizontal line representing a constant temperature of 150 °C.

↓

Gradient

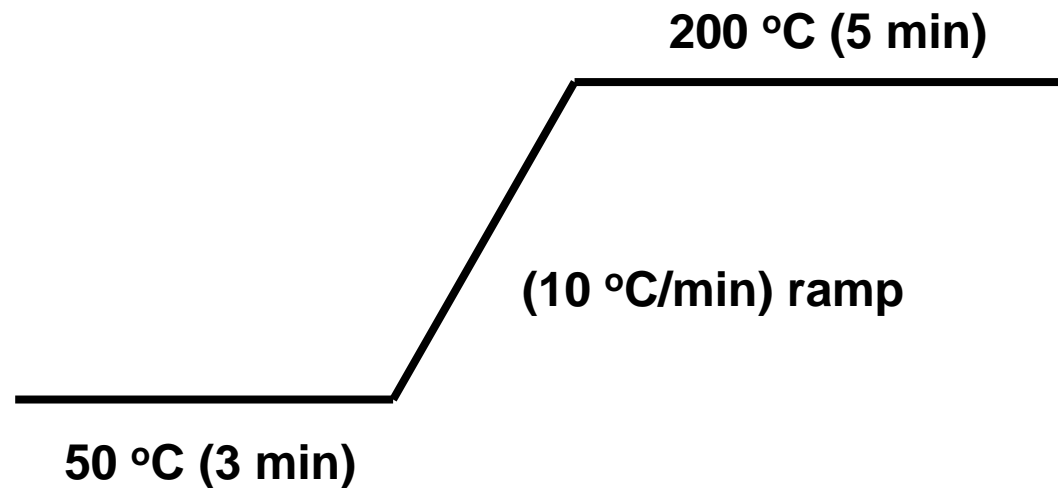

Some GC's allow for a more complex program

Temperature program

Factors to consider

- Changes in volatility of solutes.
- Stability of solutes.
- Flow rate changes.
- Stability of stationary phase.

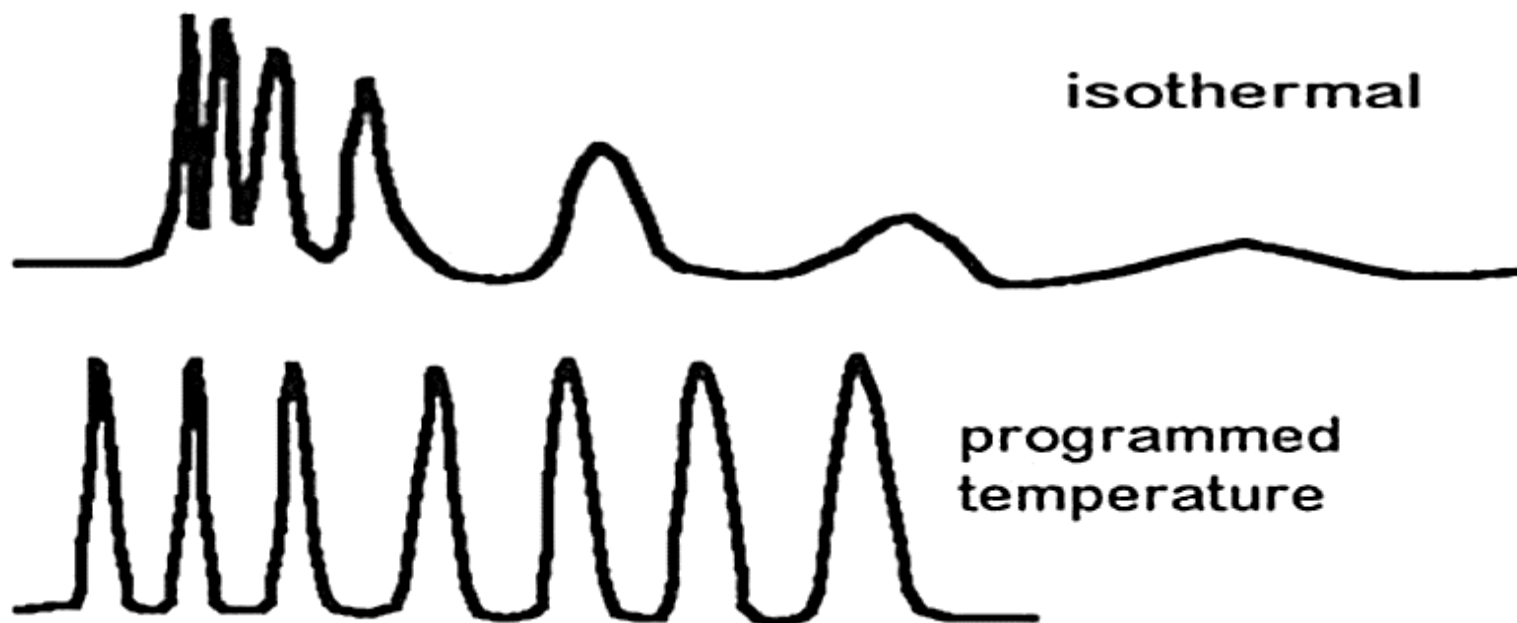

Column

Although it's usually the smallest part, the column is considered the most important component in any column chromatographic system (heart of chromatographic system).

Columns can be classified by tubing diameter and packing type.

- **Packed columns.**
- **Open tubular capillary columns.**
 - Wall-coated open tubular (WCOT)
 - Support-coated open tubular (SCOT)
 - Porous layer open tubular (PLOT)

A broad variety of tube sizes (dimensions) and materials, such as stainless steel, fused silica and glass tubes, have been used as molds for GC.

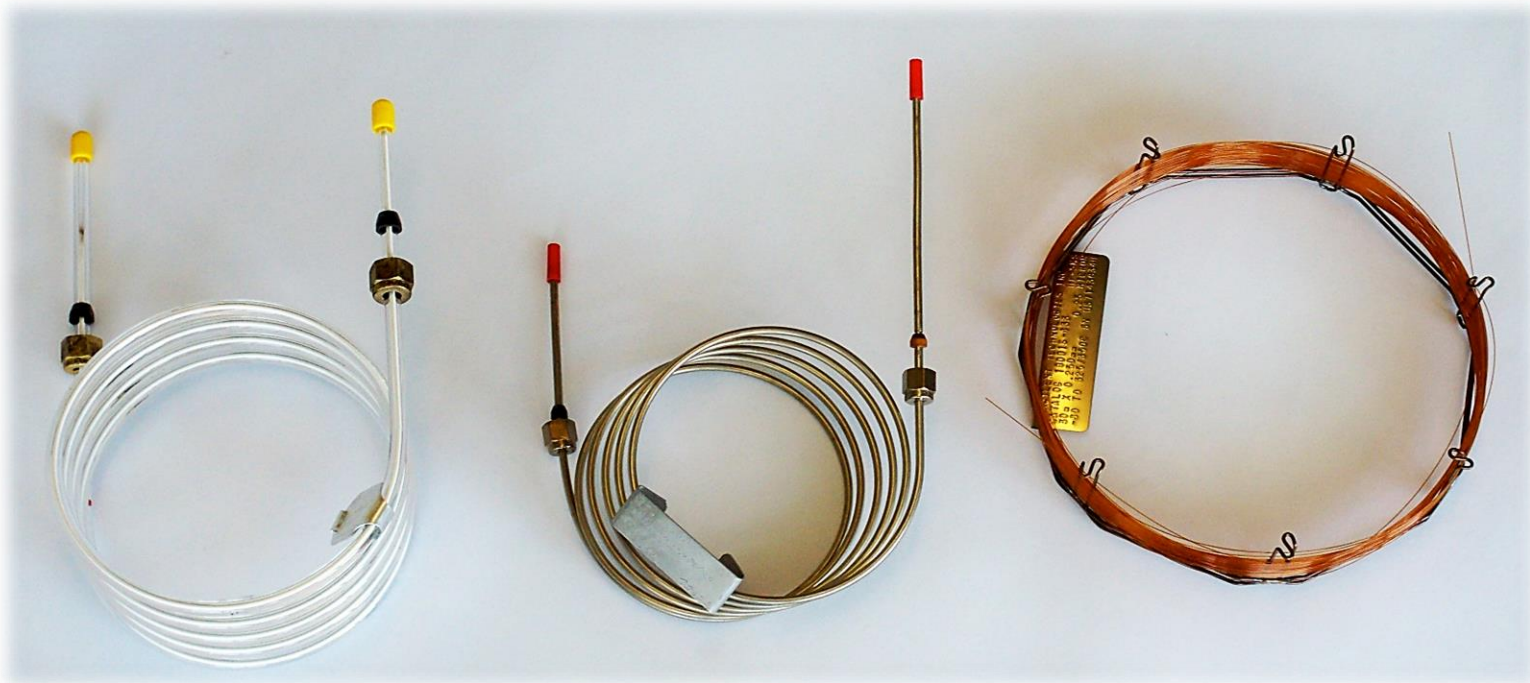

Packed vs. Open tubular capillary columns

	Packed column	Open tubular column
Length, m	0.5–5	5–100
Internal diameter, mm	2–4	0.1–0.5
Flow rate, mL/min	10–60	0.5–10
Head pressure, psig	10–40	3–40
Total plates	5,000	250,000
Capacity, $\mu\text{g}/\text{peak}$	10	0.1
Film thickness, μm	1–10	0.1–8

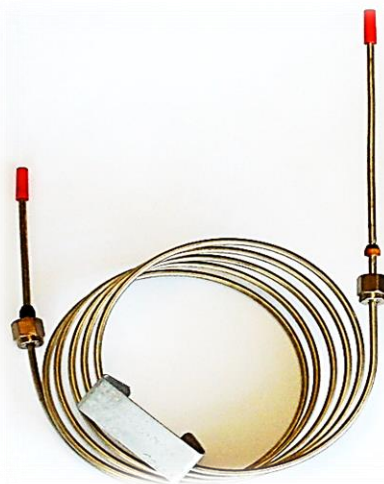
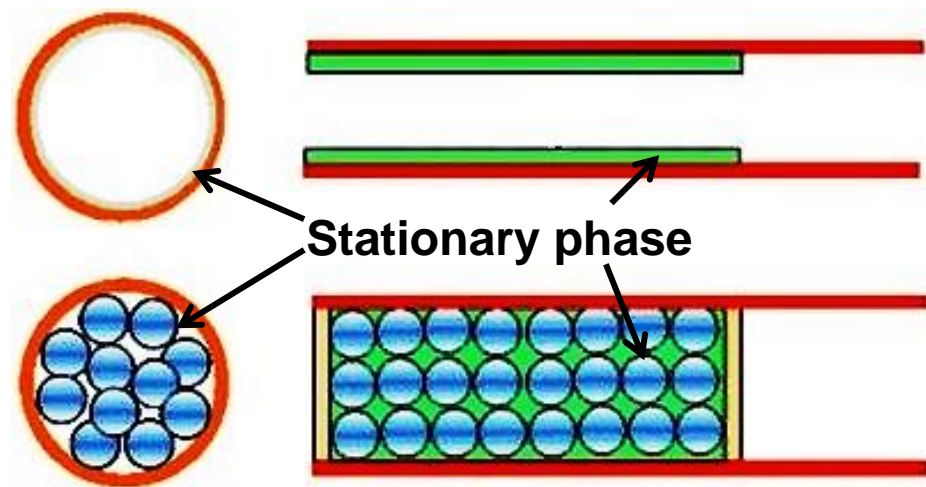

Fused silica is a synthetic quartz of high purity. A protective coating is applied to the outer surface with polyimide being the most common coating material. The polyimide coating is responsible for the brownish color of fused silica capillary columns.

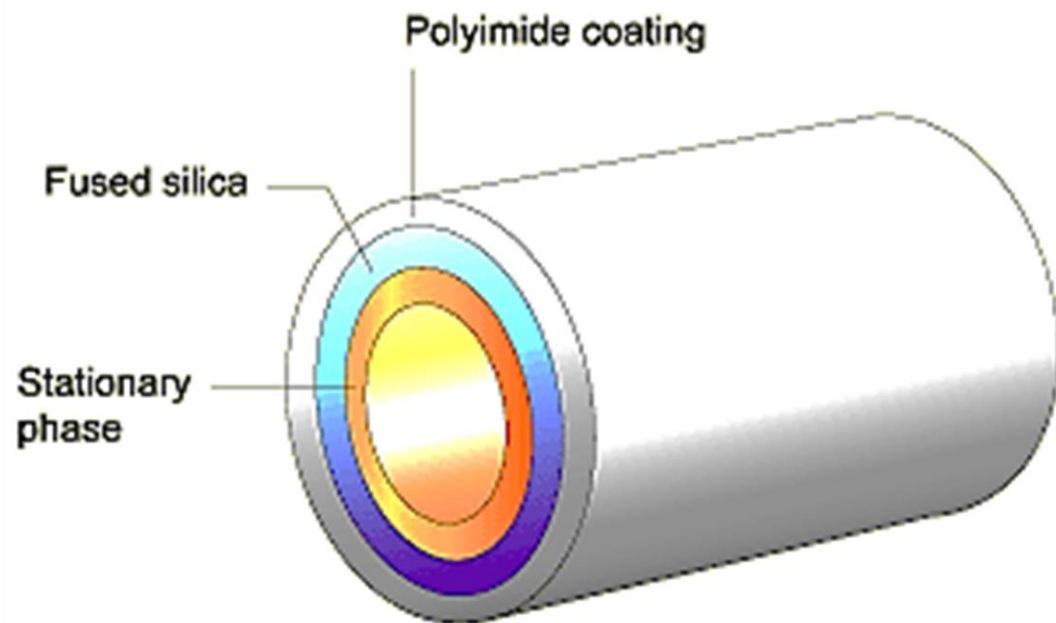

Packed vs. Open tubular columns

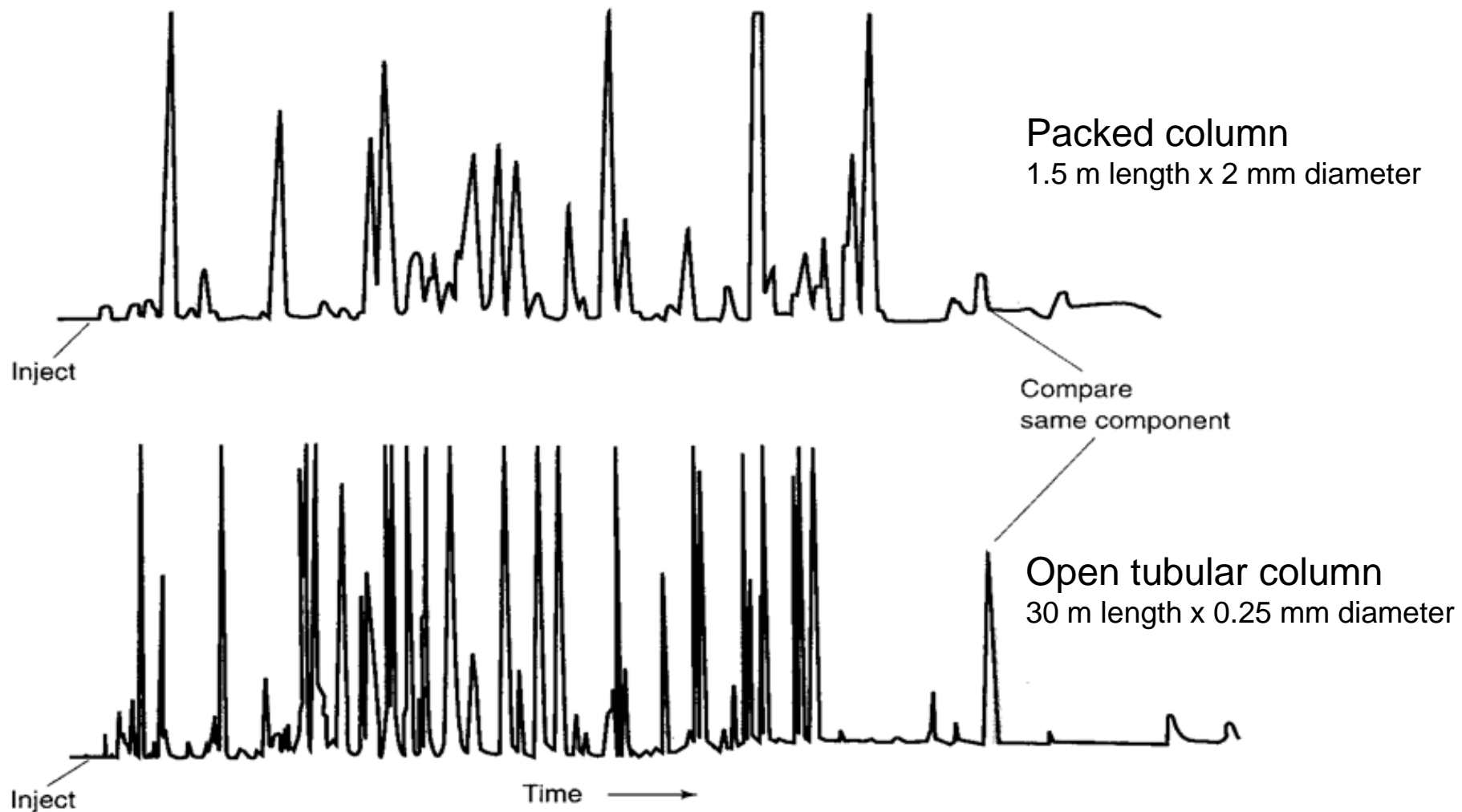

GC separation of a perfume oil

Polysiloxanes ...

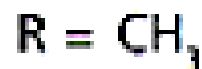
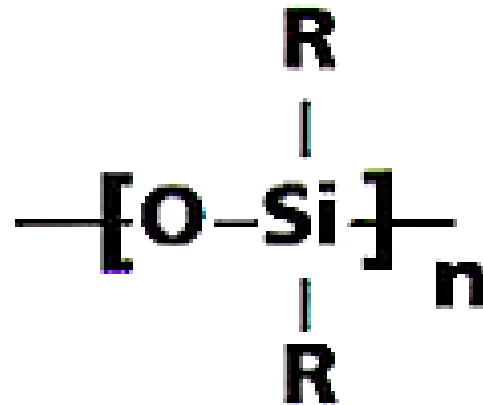

methyl



cyanopropyl



trifluoropropyl



phenyl

Stationary phases

100% dimethyl
polysiloxane
Least polar phase

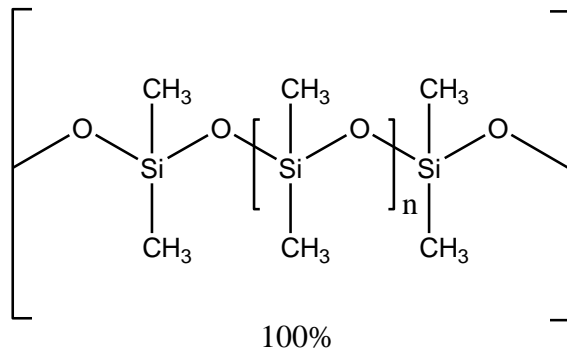

5% diphenyl
95% dimethyl
polysiloxane
Non-polar phase

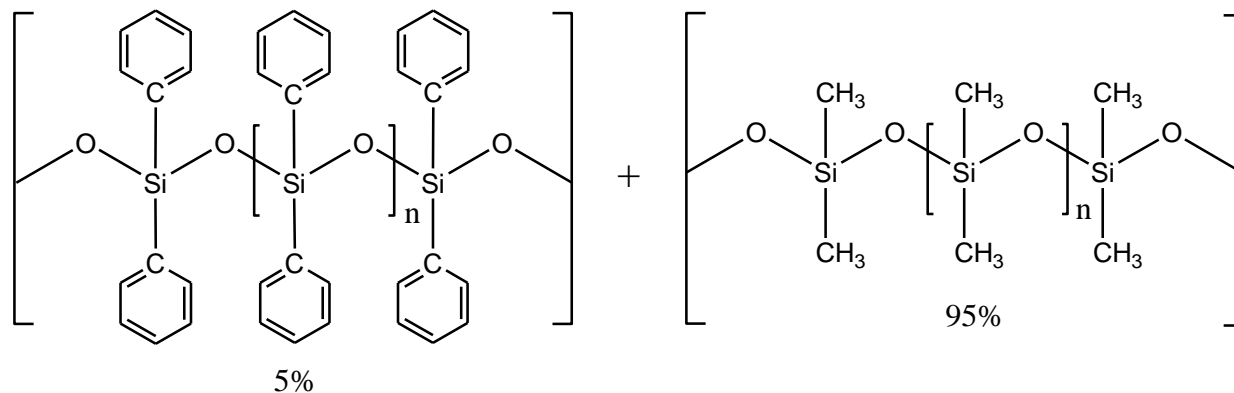

14%
cyanopropylphenyl
86% dimethyl
polysiloxane
polar phase

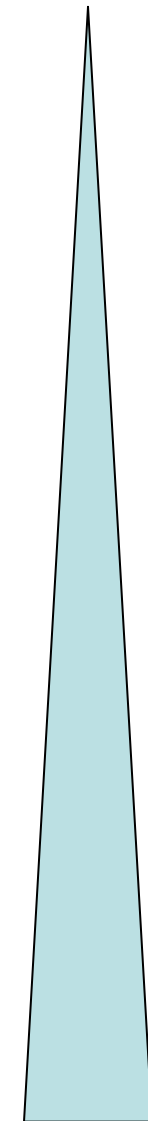
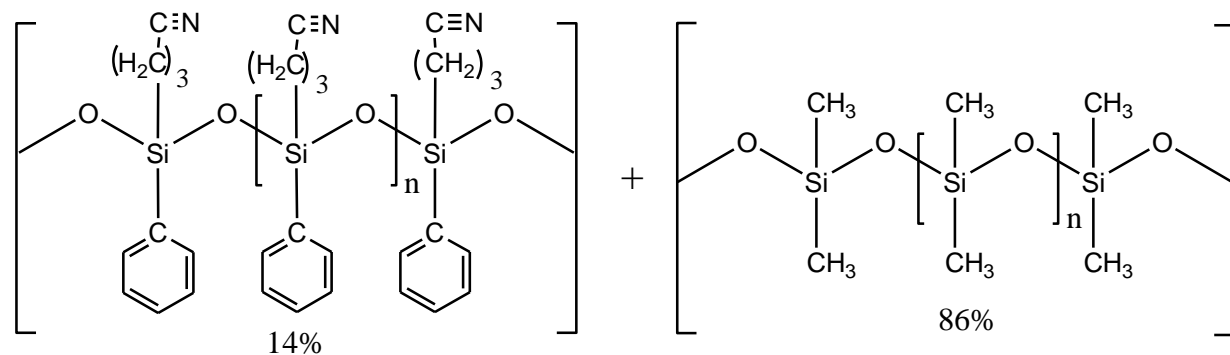

Polarity

Principle of separation

Like dissolve like (like attract like)

Non-polar stationary phases best for non-polar analytes

Polar stationary phases best for polar analytes

Stationary Phase	Common Trade Name	Maximum Temperature, °C	Common Applications
Polydimethyl siloxane	OV-1, SE-30	350	General-purpose nonpolar phase; hydrocarbons; polynuclear aromatics; drugs; steroids; PCBs
Poly(phenylmethyldimethyl) siloxane (10% phenyl)	OV-3, SE-52	350	Fatty acid methyl esters; alkaloids; drugs; halogenated compounds
Poly(phenylmethyl) siloxane (50% phenyl)	OV-17	250	Drugs; steroids; pesticides; glycols
Poly(trifluoropropyldimethyl) siloxane	OV-210	200	Chlorinated aromatics; nitroaromatics; alkyl-substituted benzenes
Polyethylene glycol	Carbowax 20M	250	Free acids; alcohols; ethers; essential oils; glycols
Poly(dicyanoallyldimethyl) siloxane	OV-275	240	Polyunsaturated fatty acids; rosin acids; free acids; alcohols

Detector

Modern detectors use a sensitive **transducer** to convert a chemical or physical property, such as pH or photon intensity, to an easily measured electrical signal, such as a voltage or current.

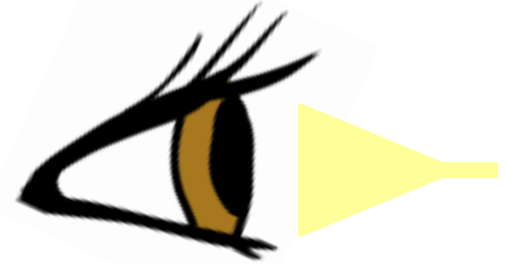

- In chromatography, the detector serve to detect the appearance of analytes at the end of the column.
- Generates an electrical signal proportional to the sample concentration.
- Provide information about the identity of analytes.
- Must be hot enough (20 to 30 °C above the column temperature).

GC detectors

GC and detector in the same instrument.

Examples...

- Flame Ionization Detector (**FID**)
 - Thermal Conductivity Detector (**TCD**)
 - Electron Capture Detector (**ECD**)
 - Nitrogen-Phosphorous Detector (**NPD**)
-

Hyphenated GC methods; GC attached to a second instrument.
Exploit advantage of each method.

Examples...

- Mass Spectrometry (**GC-MS**)
- Infrared Spectrometry (**GC-FTIR**)
- Nuclear Magnetic Resonance (**GC-NMR**)
- Atomic Absorption Spectroscopy (**GC-AAS**)
- Atomic Emission Spectroscopy (**GC-AES**)
- Inductively Coupled Plasma-Mass Spectrometry (**GC-ICP-MS**)

Flame Ionization Detector (FID)

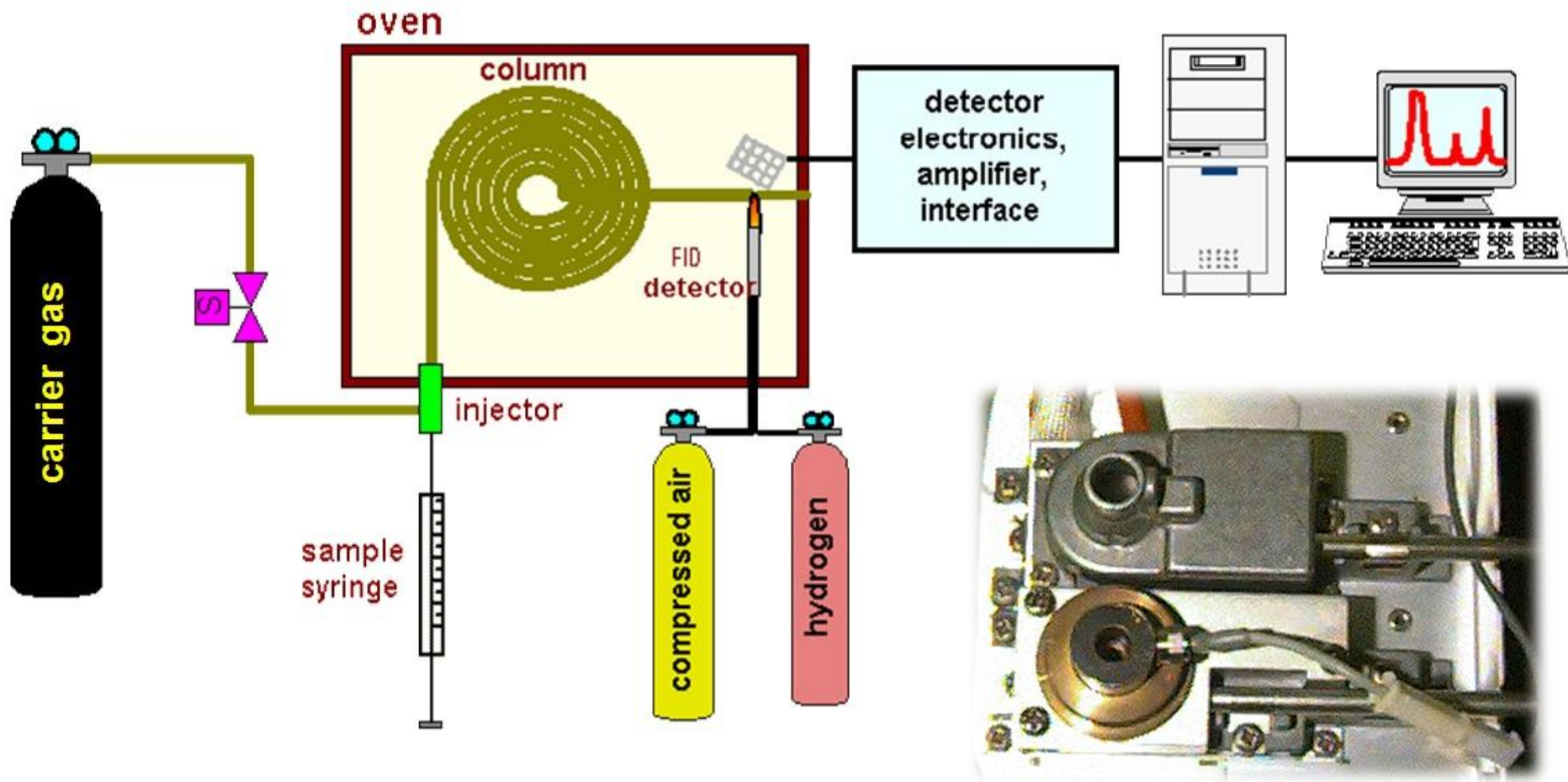

The effluent from the column is mixed with hydrogen and air and ignited.

Mode of detection

-Organic compounds burning in the flame produce ions and electrons (current) which can conduct electricity through the flame.

-Two electrodes are used to provide a potential difference. A large electrical potential is applied at the burner tip, and a collector electrode is located above the flame.

-The current resulting from the pyrolysis of any organic compound is measured which is proportional to the carbon content of the molecule entering.

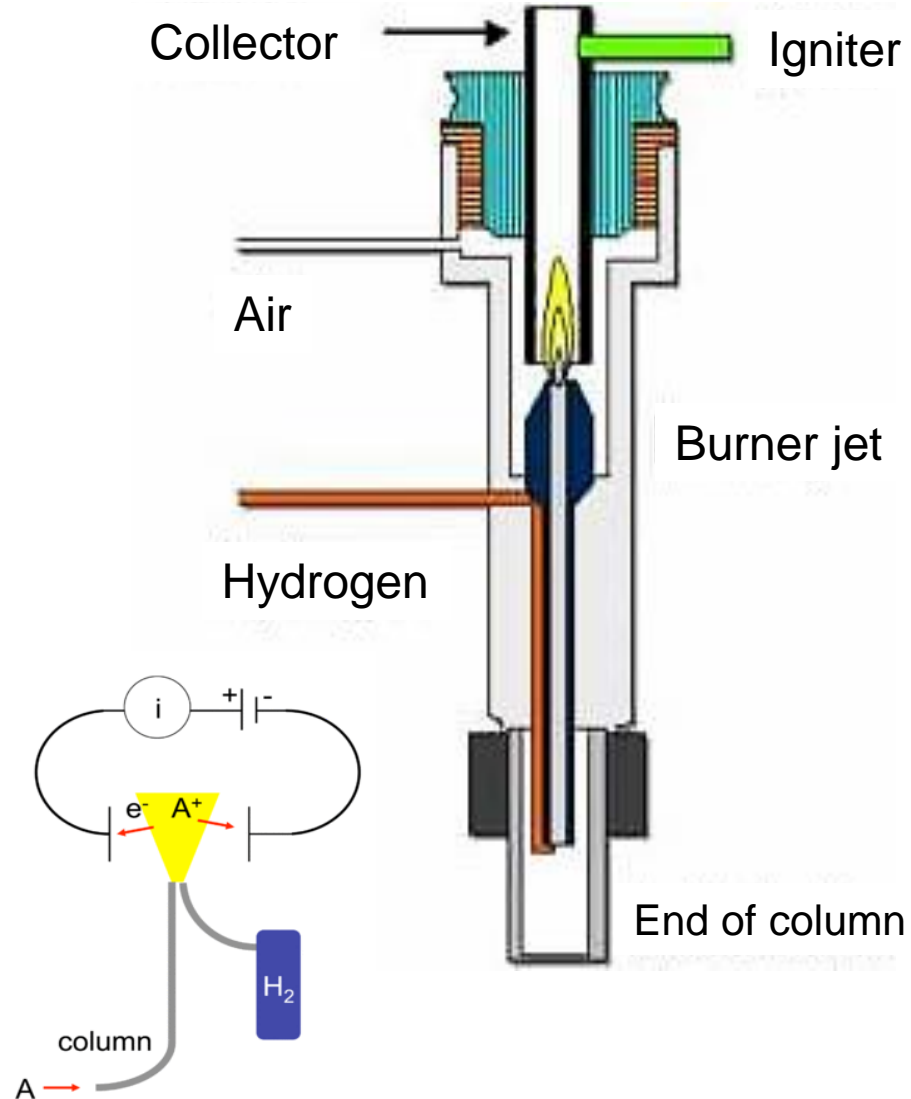

FID response

Response is based on the number of carbon and if other elements like halogens or oxygen are present which reduce combustion.

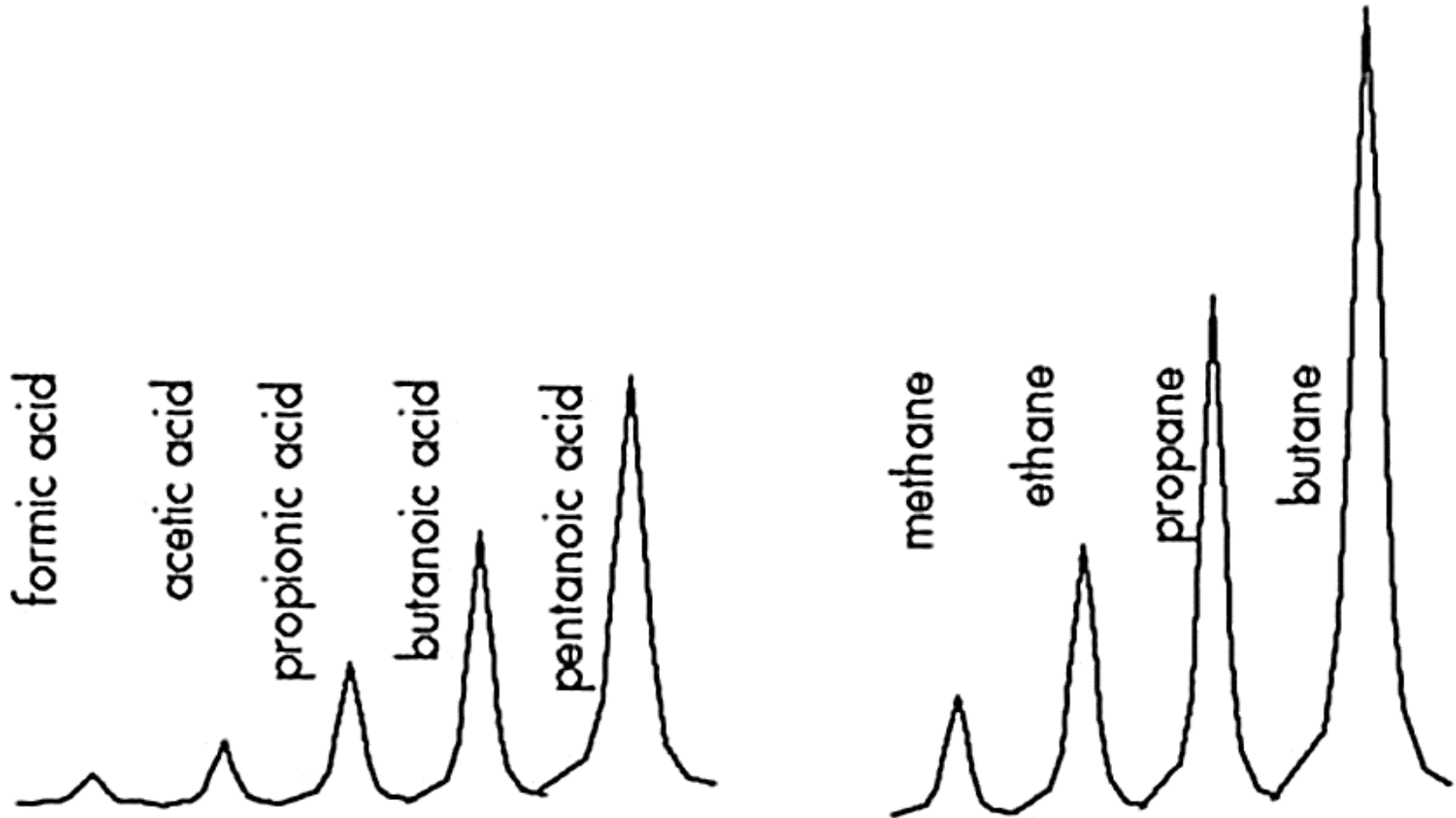

Compounds with little or no FID response

-Noble gases (He, Ne, Ar, ... etc)

-NH₃

-NO_x

-H₂O

-CO₂

-CO

-CS₂

-O₂

-N₂

-Perhalogenated compounds, CHCl₃, CCl₄,
chlorofluorocarbon (CFCs)

-Formic acid

-Formaldehyde

In some systems, CO and CO₂ can be detected in the FID using a methanizer, which is a bed of Ni catalyst that reduces CO and CO₂ to methane, which can be in turn detected by the FID.

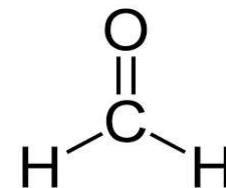
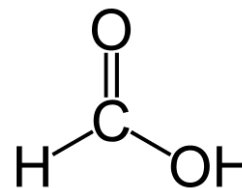
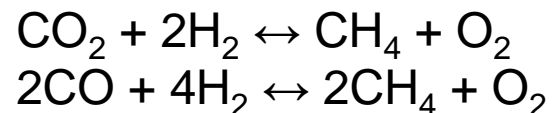

Thermal Conductivity Detector (TCD)

The thermal conductivity detector (TCD), also known as a **Katharometer**, is a bulk property detector and a chemical specific detector commonly used in gas chromatography.

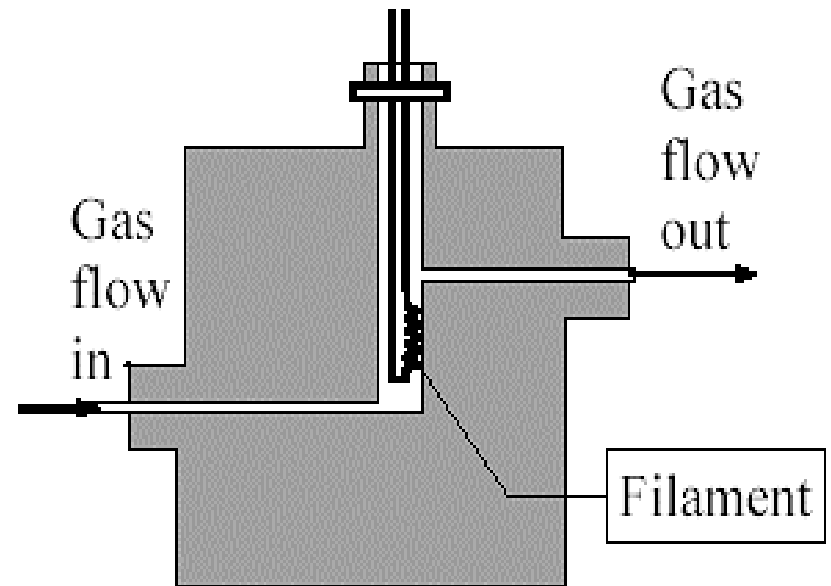
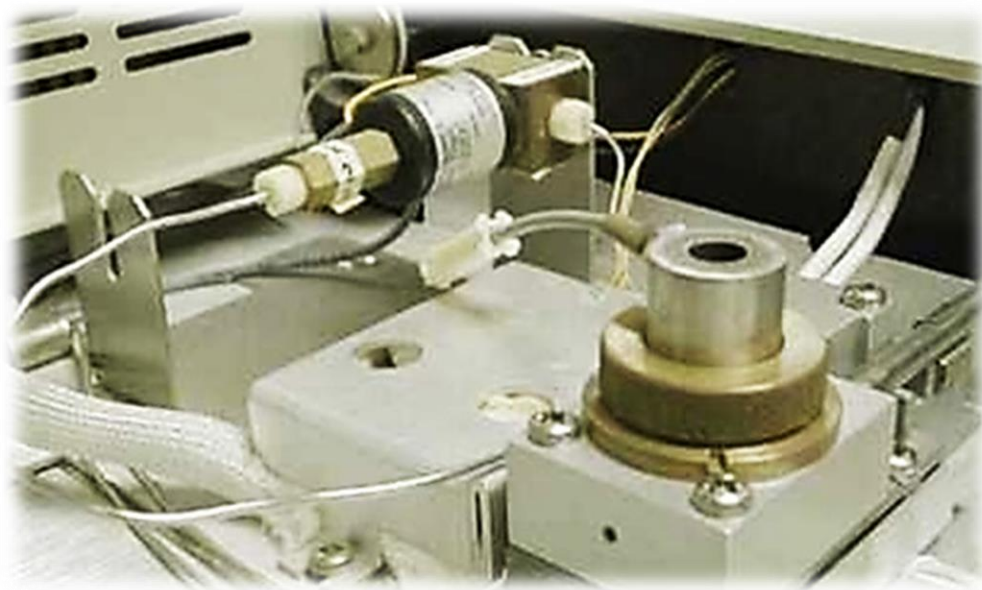

Mode of detection

The TCD consists of an electrically heated filament in a temperature-controlled cell.

Change in resistance of a wire based on variations in the thermal conductivity of the gas evolving from a column.

This detector senses changes in the thermal conductivity of the column effluent and compares it to a reference flow of carrier gas.

Since most compounds have a thermal conductivity much less than that of the common carrier gases of He or H₂, when an analyte elutes from the column the effluent thermal conductivity is reduced, and a detectable signal is produced.

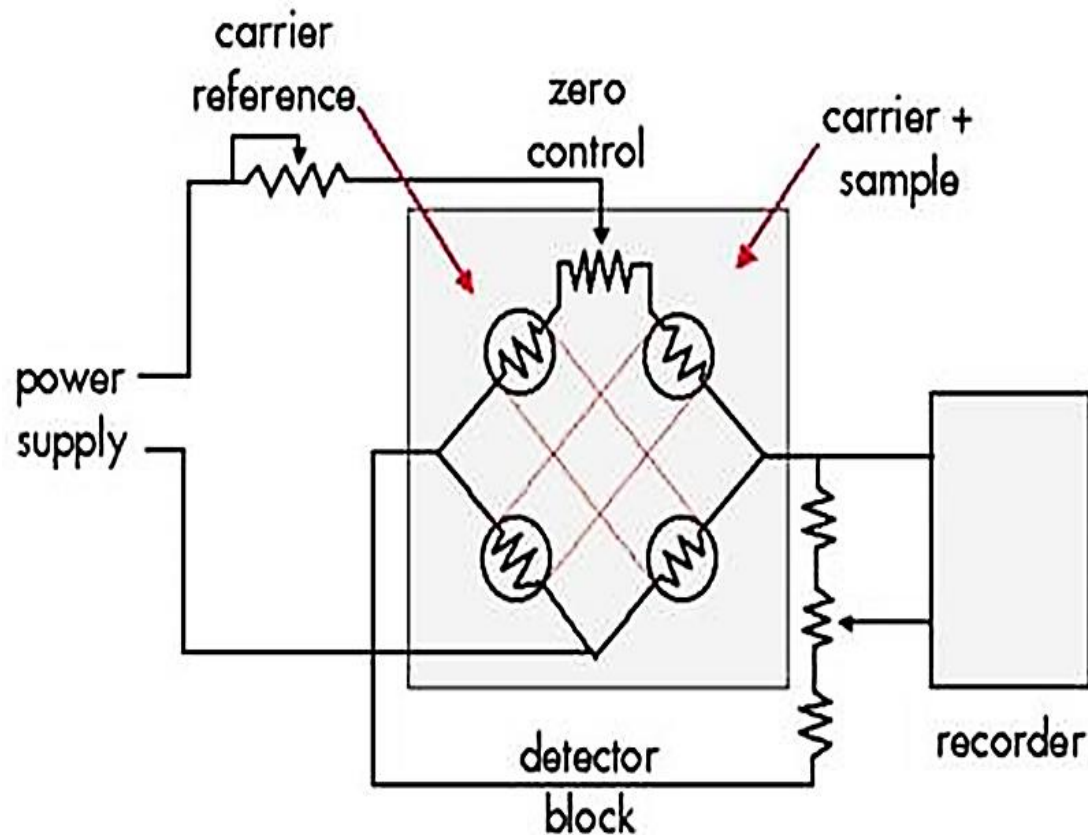

TCD vs. FID response

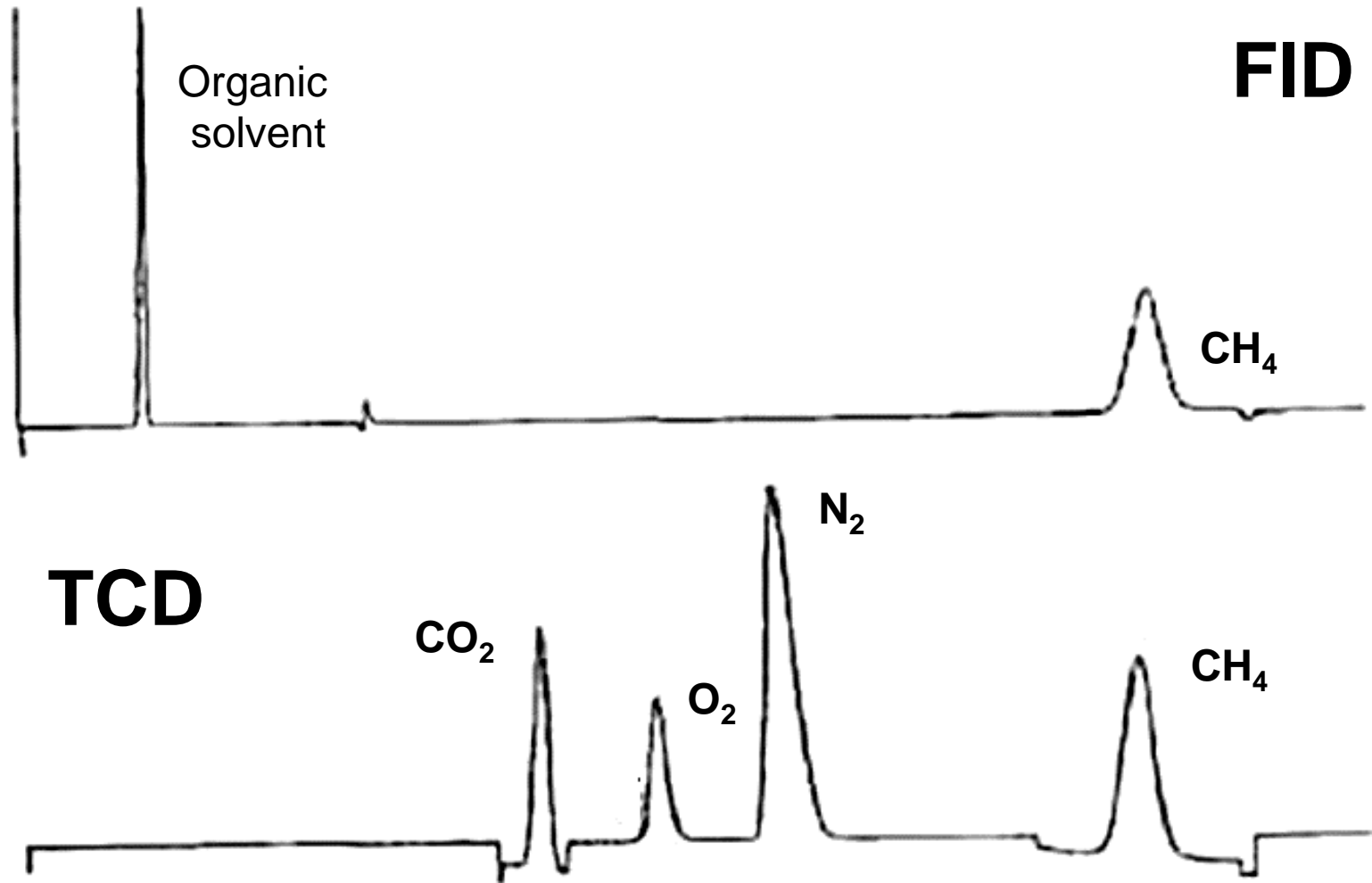

Mass Spectrometry (GC-MS)

- Synergistic combination of two powerful analytical techniques.
- The GC separates the components of a mixture in time.
- The MS provides information that aids in the structural identification of each component.
- Uses the difference in mass-to-charge ratio (m/z) of ionized atoms or molecules to separate them from each other.

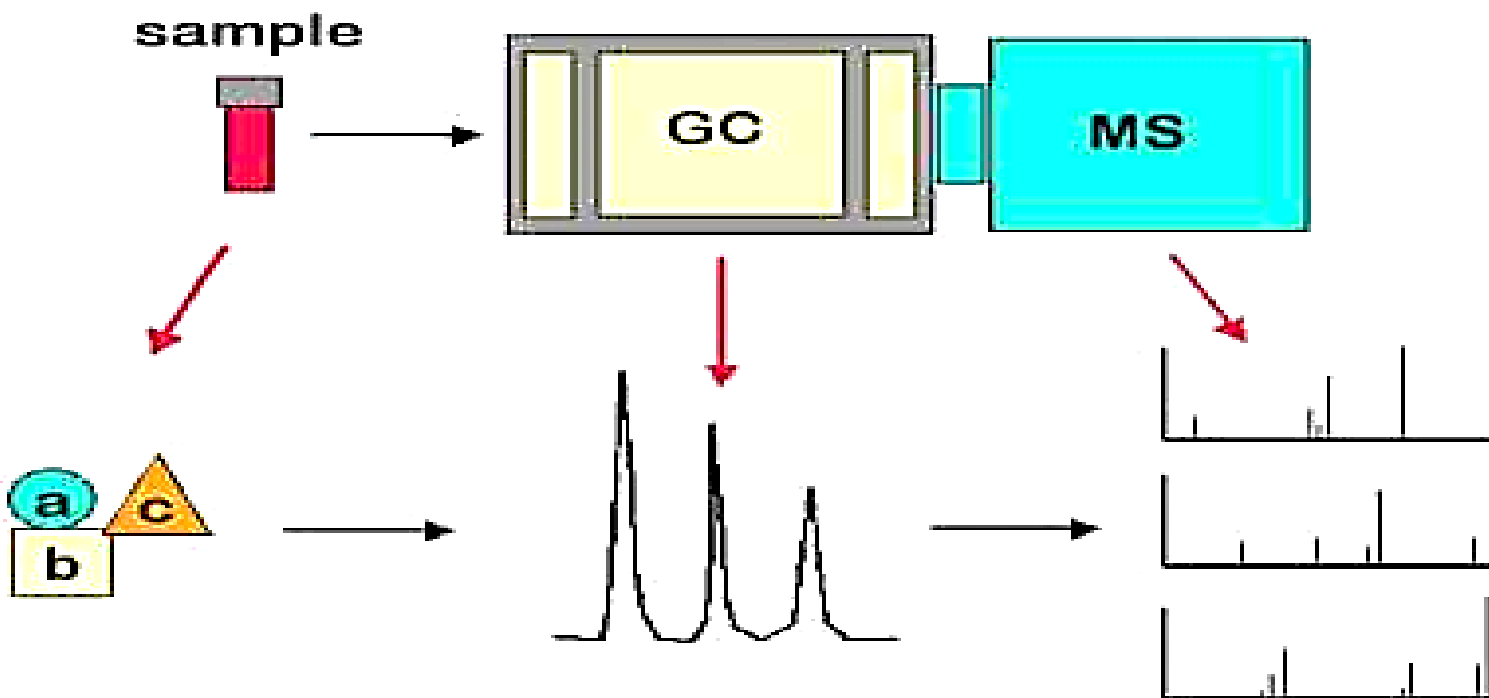

The general operation of a mass spectrometer is:

- Result of the GC goes through an ionizer where it is bombarded by a high energy electron beam.
- This beam breaks the complex molecules into a standard set of fragments.
- The ionized samples then go through magnetic field which deflects ion according to mass to charge ratio.
- A detector picks up the fragments of a certain mass.
- Each peak of a chromatogram becomes a “fingerprint” of the compound.
- The fingerprints are compared with a library to identify the compounds.

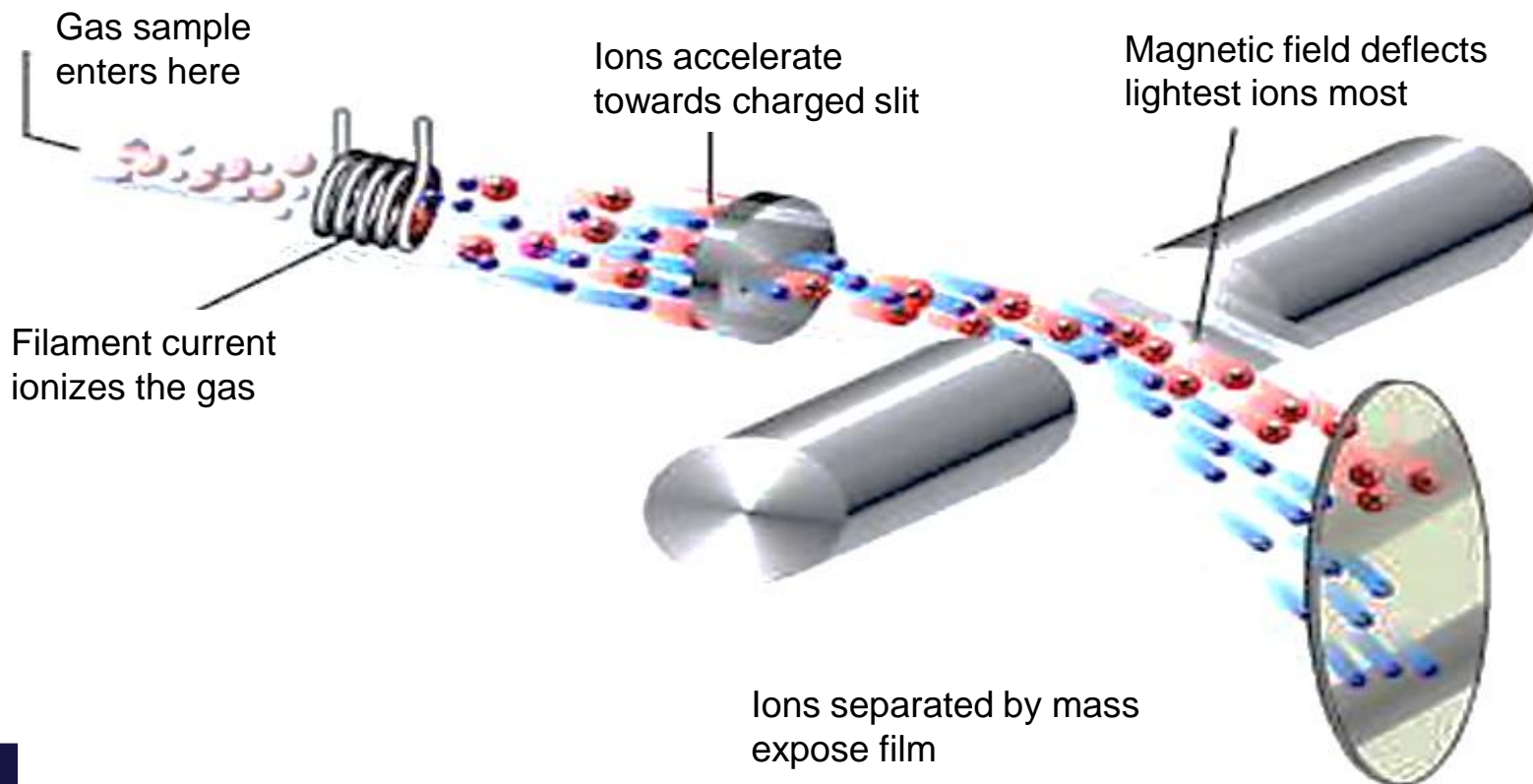

GC-MS example

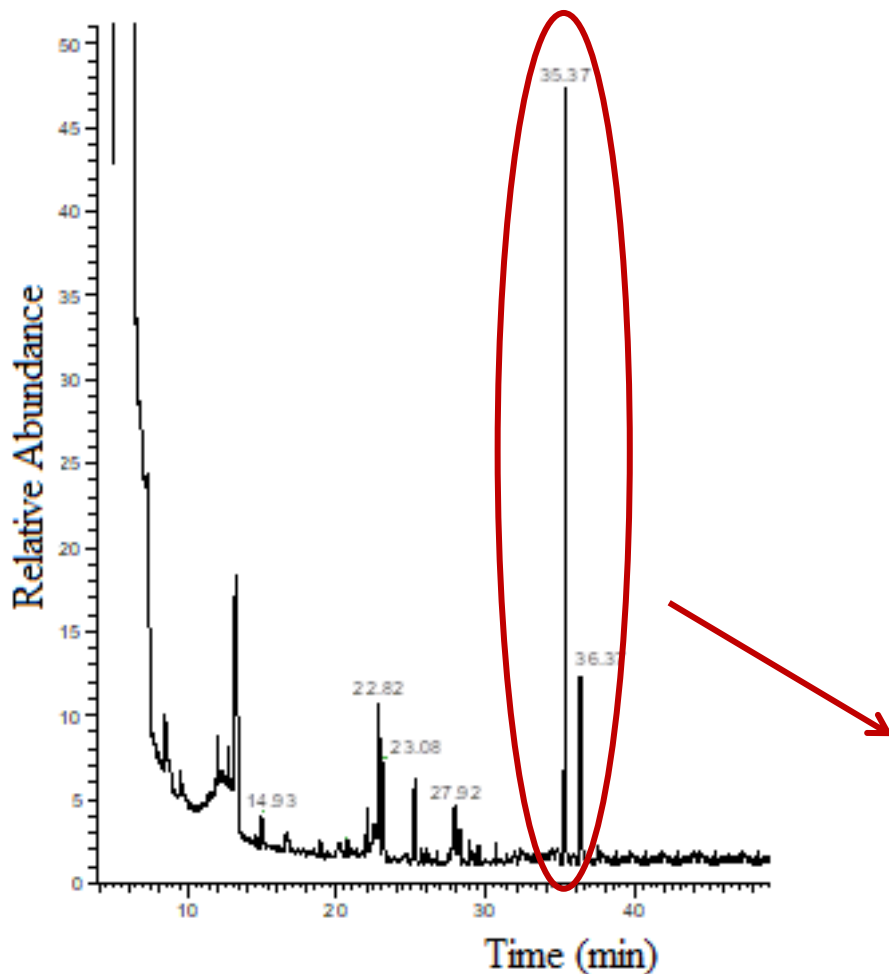

- Identification of the mixtures constituents
- Check the purity of the compound

GC-MS Conditions

Column	DB-5MS (Agilent) 30 m × 0.25 mm × 0.25 μm
Carrier gas	Helium
Column flow	1.0 mL/min
Injection mode	Splitless mode (1 μL)
Oven temp.	70 °C (2 min) 20 °C/min, 230 °C
Injector temp.	280 °C
Interface temp.	280 °C
Ion source temp.	230 °C
Ionization energy	70 eV (EI)

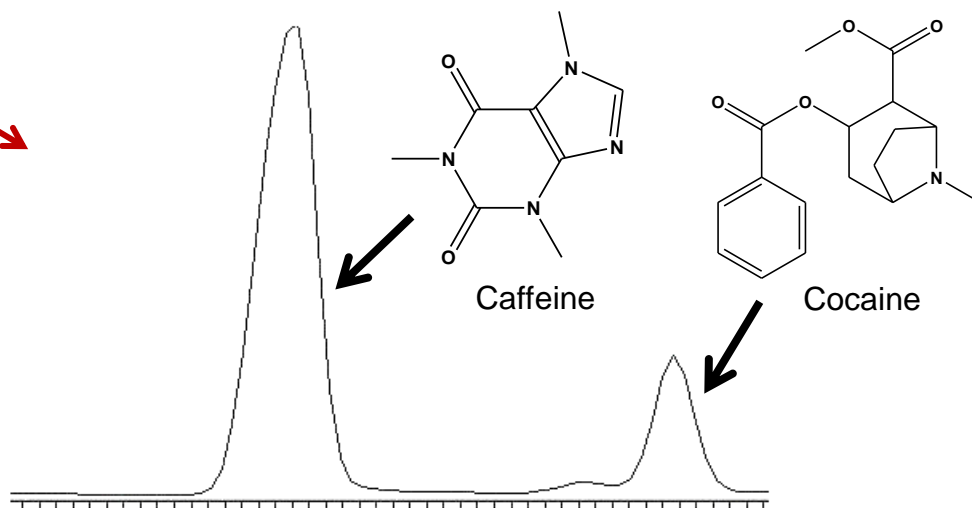

GC-MS Library Search

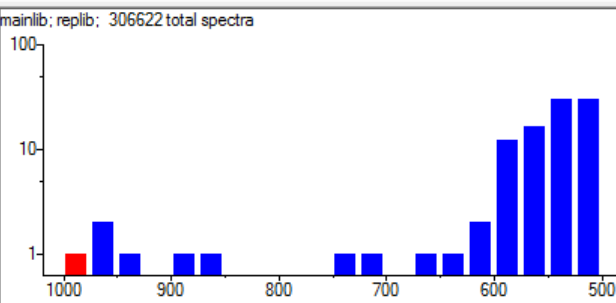
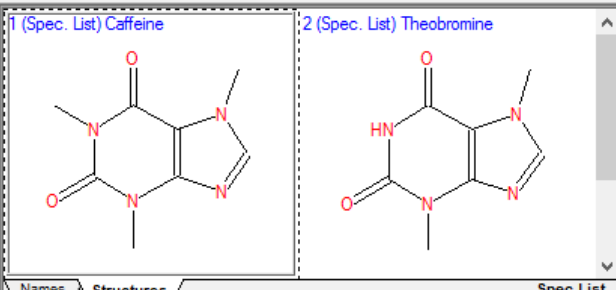

#	Lib.	Match	R.Match	Prob. (%)	RI	Syn	DBs	Name
1	M	999	999	98.8	1...	65	9	Caffein.
2	R	974	974	98.8	1...	65	9	Caffein.
3	R	952	956	98.8	1...	65	9	Caffein.
4	R	928	930	98.8	1...	65	9	Caffein.
5	R	882	882	98.8	1...	65	9	Caffein.
6	R	873	884	98.8	1...	65	9	Caffein.
7	R	748	810	0.98	-	1	0	1,4-D.
8	M	705	709	0.98	-	1	0	1,4-D.
9	M	656	679	0.08	-	0	0	6-Ami.
10	R	627	627	0.02	2...	27	5	Proxy.
11	M	614	614	0.02	2...	27	5	Proxy.
12	M	604	801	0.00	-	0	0	2-Flu...
13	M	595	758	0.00	-	0	0	4-Flu...
14	R	592	596	0.00	1...	7	2	9-Tet.
15	M	591	591	0.00	-	0	0	Dyph.
16	M	591	591	0.00	-	1	0	Dode.
17	M	590	603	0.00	-	0	0	3,3'...
18	M	589	603	0.00	-	2	0	2H-1.
19	R	586	592	0.00	1...	0	0	1,8-D.
20	M	585	588	0.00	-	0	0	Valer

Names Structures InLib = 856, Hit List

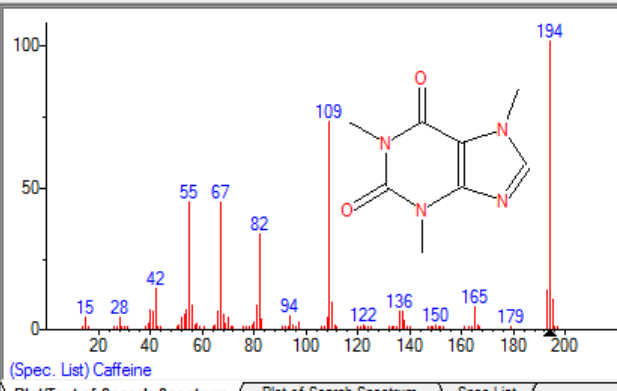

Name: Caffeine
 Formula: C₈H₁₀N₄O₂
 MW: 194 Exact Mass: 194.080376 CAS#: 58-08-2 NIST#: 290714 ID#: 1 DB: S
 Other DBs: Fine, TSCA, RTECS, EPA, USP, HODOC, NIH, EINECS, IRDB
 Comment: NIST Mass Spectrometry Data Center, 1998.
 Related CAS#: 71701-02-5; 95789-13-2
 InChIKey: RYYVLZVUVJVGH-UHFFFAOYSA-N Non-stereo
 10 largest peaks:
 194 999 | 109 721 | 55 439 | 67 438 | 82 328 |
 42 138 | 193 135 | 195 103 | 110 92 | 81 81 |
 Synonyms:
 1. 1H-Purine-2,6-dione, 3,7-dihydro-1,3,7-trimethyl-
 2. Alert-Pep
 3. Cafeina
 4. Caffein
 5. Caffeine
 6. Cafipel

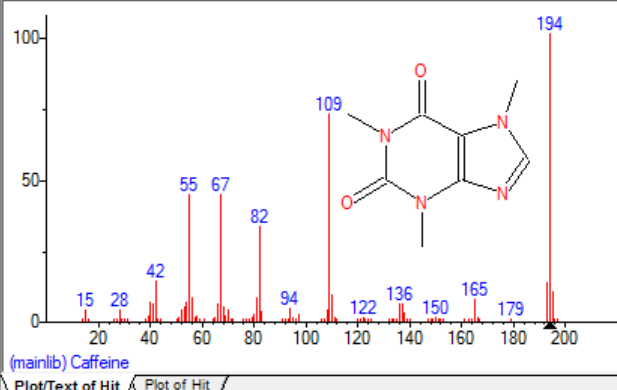
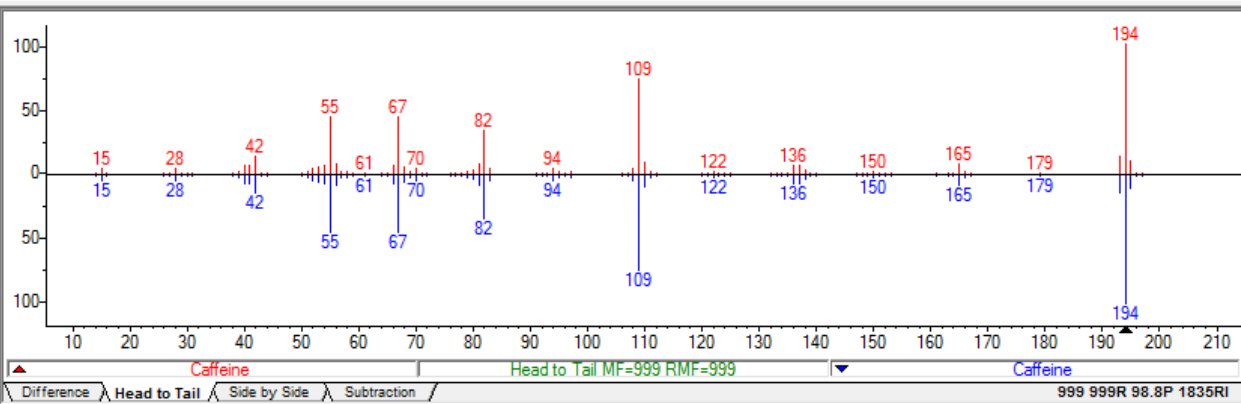

Name: Caffeine
 Formula: C₈H₁₀N₄O₂
 MW: 194 Exact Mass: 194.080376 CAS#: 58-08-2 NIST#: 290714 ID#: 198382
 Other DBs: Fine, TSCA, RTECS, EPA, USP, HODOC, NIH, EINECS, IRDB
 Contributor: NIST Mass Spectrometry Data Center, 1998.
 Related CAS#: 71701-02-5; 95789-13-2
 InChIKey: RYYVLZVUVJVGH-UHFFFAOYSA-N Non-stereo
 10 largest peaks:
 194 999 | 109 721 | 55 439 | 67 438 | 82 328 |
 42 138 | 193 135 | 195 103 | 110 92 | 81 81 |
 Synonyms:
 1. 1H-Purine-2,6-dione, 3,7-dihydro-1,3,7-trimethyl-
 2. Alert-Pep
 3. Cafeina
 4. Caffein
 5. Caffeine
 6. Cafipel

GC detectors; applications and sensitivity ranges

Gas Chromatographic Detectors		
Type	Applicable Samples	Typical Detection Limit
Flame ionization	Hydrocarbons	0.2 pg/s
Thermal conductivity	Universal detector	500 pg/mL
Electron capture	Halogenated compounds	5 fg/s
Mass spectrometer	Tunable for any species	0.25–100 pg
Thermionic	Nitrogen and phosphorous compounds	0.1 pg/s (P) 1 pg/s (N)
Electrolytic conductivity (Hall)	Compounds containing halogens, sulfur, or nitrogen	0.5 pg Cl/s 2 pg S/s 4 pg N/s
Photoionization	Compounds ionized by UV radiation	2 pg C/s
Fourier transform IR	Organic compounds	0.2 to 40 ng

Factors Influencing the GC Separation

The major interrelated factors to consider

- Carrier gas type and purity
- Carrier gas velocity (flow rate)
- Injection method (manual, automatic, speed, syringe, headspace, SPME, ...)
- Injector temperature
- Injection mode (split/splitless)
- Injection volume
- Column stationary phase
- Column length
- Column internal diameter
- Film thickness for stationary phase (open tubular columns)
- Column (oven) temperature; isothermal or temperature program
- Pressure
- Type of detector
- Detector temperature
- Detector conditions



Thank You!

