

**OLYMPUS**

# Basics of Polarizing Microscopy

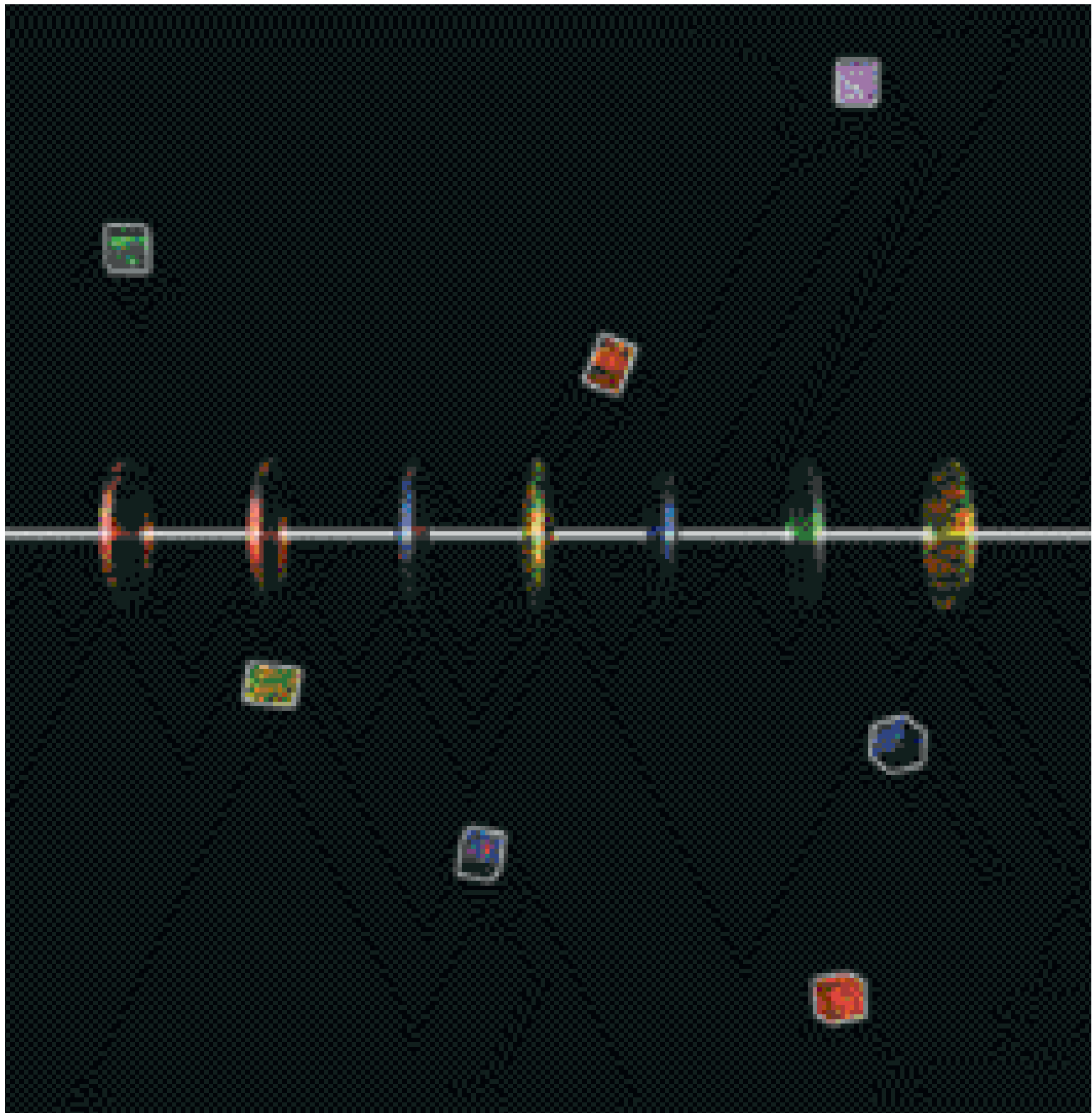

# 1. Properties of polarized light

## KEYWORD

Polarized light

Linearly polarized light

Circularly polarized light

Elliptically polarized light

Polarizing plate

Polarizing filter

Polarizing prism

Polarizer

Analyzer

Crossed nicols

Parallel nicols

## 1.1 Polarized light

Transverse wave light whose vibration possess direction is called polarized light. Light from an ordinary light source (natural light) that vibrates in random directions (Fig. 1.1) is called nonpolarized light. In contrast, while light with vertical vibration that travels within a single plane (Fig. 1.2a) is called linearly polarized light, circularly polarized light (Fig. 1.2b) and elliptically polarized light (Fig. 1.2c) are types of light in which the vibration plane rotates forward.

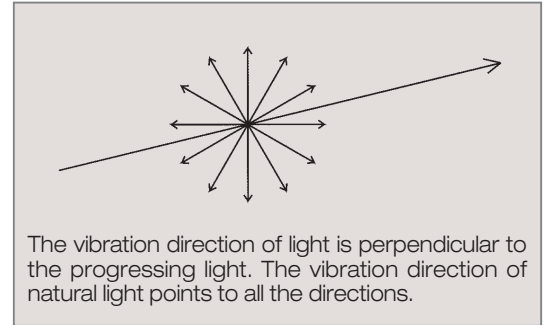

● Fig. 1.1 Natural light (nonpolarized light) ●

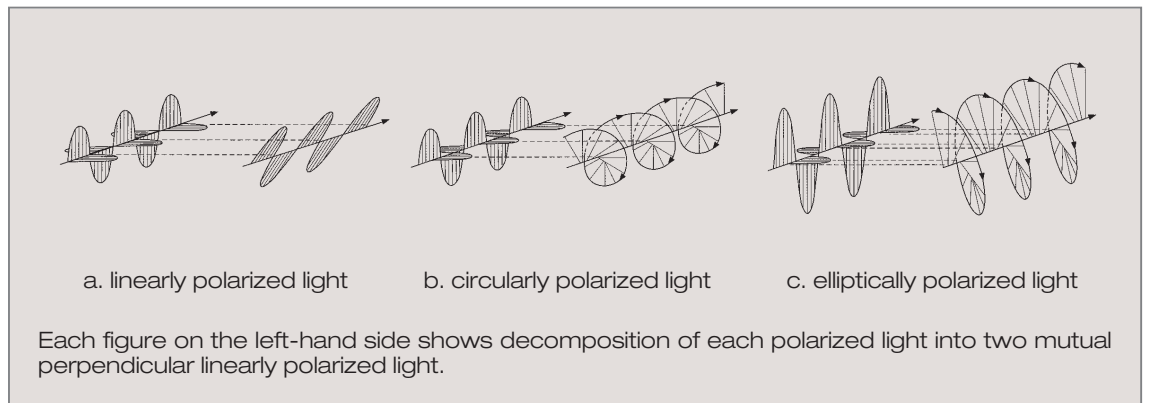

● Fig. 1.2 Types of polarized light ●

A polarizing plate (polarizing filter) or polarizing prism is often used as the device to change natural light to linearly polarized light (see 1.7). Configuring the primary and secondary polarizing devices in the orthogonal directions of each transmitting linearly polarized ray will cut the light. Such state in which the primary light polarizing device is the polarizer and the secondary device is the analyzer is called crossed nicols. Parallel nicols is the state in which the analyzer is rotated to make the direction of the transmitting linearly polarized light match with the polarizer, and the amount of light transmittance is maximized. (Fig. 1.3b).

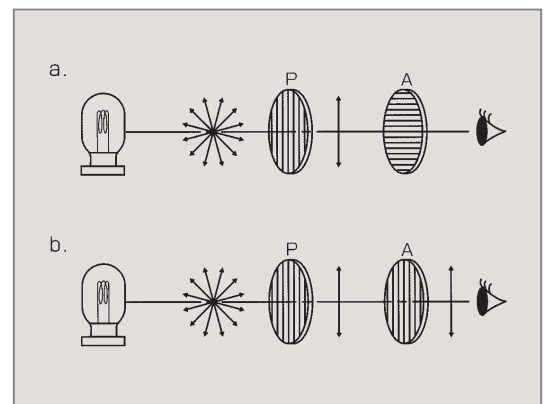

● Fig. 1.3 a) crossed nicols and b) parallel nicols ●  
P: polarizer A: analyzer

**KEYWORD**

Component P

Component S

Brewster angle

Calcite

Double refraction

Ordinary ray

Extra ordinary ray

Anisotropy

Optical axis

## 1.2 Polarization by reflection

When light reflects off the surface of water and glass, its reflectance varies with the direction of polarization (Fig. 1.4a). Comparing the two oscillation components, Component P is parallel to the plane of incidence and has 0 reflectance while Component S is perpendicular to the plane and has higher reflectance. The 0 reflectance of Component P is caused by the existence of an angle of incidence, known as the Brewster angle. In other words, the reflected light at this angle is linearly polarized, and can be cut out with a polarizing plate. In photography, a polarizing filter is used in order to remove reflection from the surface of water and glass (Fig. 1.4b). The Brewster angle against the surface of water ( $n=1.33$ ) and the surface of glass ( $n=1.52$ ) is  $53^{\circ}07'$  and  $56^{\circ}40'$ , respectively.

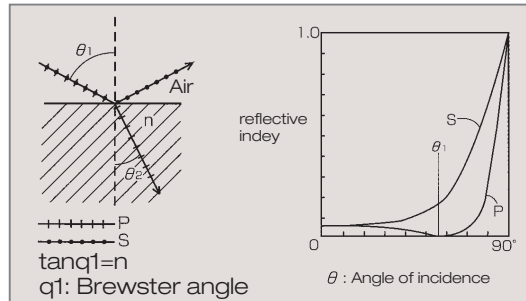

● Fig. 1.4 a) Difference of reflectance is due to vibration direction of light ●



● b) Effectiveness of polarizing filter (left: without filter right: with filter) ●

## 1.3 Double refraction

An object whose image passes through a calcite  $\text{CaCO}_3$  crystal appears doubled (Fig. 1.5a). This phenomenon is called double refraction or birefringence, which occurs when light that is launched through a crystal material is divided into two linearly polarized light rays having mutually crossing vibration directions, and then refracted. Among these two light rays, the one that follows the law of refraction is called an ordinary ray, while the other one is called an extraordinary ray. Their speed and index of refraction differ from one another.

A crystal that refracts in such way is called an anisotropy. Light passing through an anisotropy is generally divided into ordinary and extraordinary rays, but toward a certain direction called optical axis, they travel together. When that happens, the double refraction phenomenon does not occur. (see 1.4).



● Fig. 1.5a. Double refraction phenomenon due to calcite ●

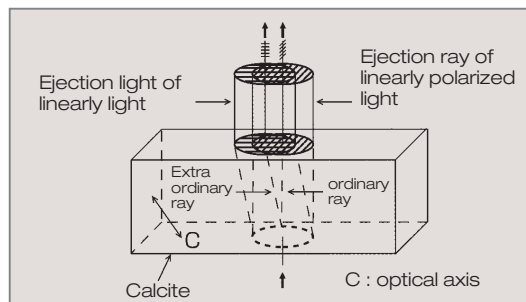

● Fig. 1.5b. Double refraction phenomenon due to diagram ●

**KEYWORD**

Optically uniaxial crystal

Optically biaxial crystal

Principal section

Optically positive crystal

Optically negative crystal

Optical character

Index surface

Principal refractive

**1.4 Optically uniaxial crystal**

Anisotropy can be divided into an optically uniaxial crystal and an optically biaxial crystal according to the optical properties. An optically uniaxial crystal has one optical axis while an optically biaxial crystal has two axes. A material classification in terms of optical properties is as follows:

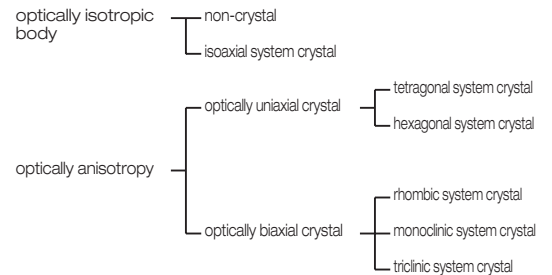

The optical axis and the direction of a beam of light determine the vibration direction of extraordinary and ordinary rays in an optically uniaxial crystal, and the section containing both rays is called the principal section. The ordinary rays oscillate vertically through the principal section while the extraordinary rays oscillate within the principal section (Fig. 1.6).

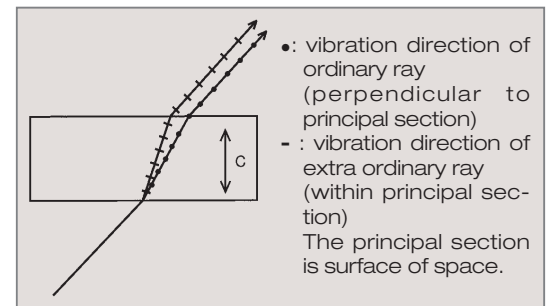

Fig. 1.6 Vibration direction of ordinary rays and extraordinary rays of an optically uniaxial crystal

Optically uniaxial crystals can be divided into two types: optically positive crystals, in which the index of refraction of extraordinary rays is greater than that of ordinary rays, and vice versa, called optically negative crystals (hereafter, positive crystals and negative crystals). For instance, rock crystals belong to positive crystals, whereas calcite and sapphires belong to negative crystals. Positive and negative crystals can also be said to possess a positive or negative optical character, respectively.

The index of refraction of extraordinary rays varies with the direction of progression of light rays. Figure 1.7 shows the index surface for optically uniaxial crystals with a) a positive crystal, and b) a negative crystal. The index surface expresses the index of refraction toward the direction of progression of ordinary rays and extraordinary rays in terms of the distance from the origin. As shown in the diagram, the index of refraction of extraordinary rays inclined by  $q$  from the optical axis is  $n_e$ . The index of refraction of extraordinary rays reaches a maximum or minimum perpendicularly along the direction of the optical axis. The indices of refraction of the ordinary and extraordinary rays in this direction,  $w$  and  $e$ , respectively, are called principal refractive indices. The principal refractive indices for significant crystals are given in table 1.1.

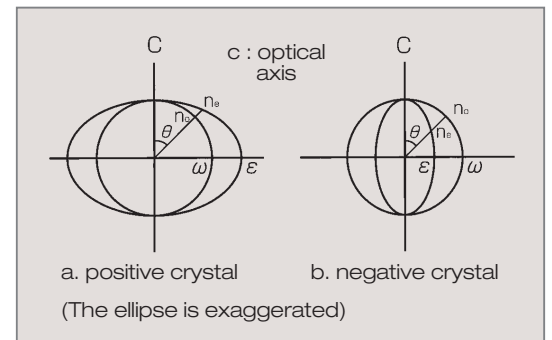

Fig. 1.7 Index surface of an optically uniaxial crystal

Crystal name	$w$	$e$
rock crystal (quartz)	1.5443	1.5534
calcite	1.6584	1.4864
sapphire	1.768	1.760

Table 1.1 Principal refractive indices of significant crystals (wavelength = 589.3 nm)

# 1. Properties of polarized light

## KEYWORD

X' direction

Z' direction

Optical axial angle

Phase difference

Retardation

In double refraction, the vibration direction of light with faster progression is called the X' direction, while the slower progression is called the Z' direction. As for the vibration direction, the positive crystals represent the direction of extraordinary rays, whereas the negative crystals express that of the ordinary rays in the Z' direction of optically uniaxial crystals. In the test plate and compensator of a polarizing microscope (see 3.2.8), the Z' direction is displayed for investigating the vibration direction of the light for specimens. Generally, even optically biaxial crystal will separate in two rays, and yet they are both extraordinary rays whose speed differs according to the direction of its progression. See Fig. 1.8 for the index surface of optically biaxial crystals. a, b, and g show the principal refractive indices of optically biaxial crystals. The angle that constitutes the two optical axes ( $2\Omega$ ) is called the optical axial angle.

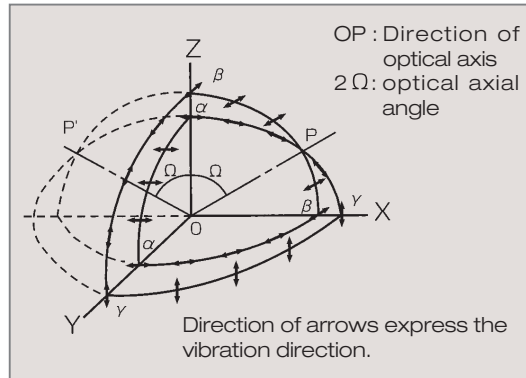

● Fig. 1.8 Section of refractive index of an optically biaxial crystal ●

## 1.5 Retardation

After being launched into an anisotropy, phase differences will occur between the ordinary and extraordinary rays. Fig. 1.9 shows the relationship between the direction of the optical axis and double refraction. In cases (a) and (b) in Fig. 1.9, relative surges and delays, i.e., phase differences,  $\delta$ , will occur between the two rays. On the contrary, no phase difference can be seen in Fig. 1.9c because light rays advance in the direction of the optical axis.

The phase difference for extraordinary and ordinary rays after crystal injection is given next.

$$\delta = 2\pi d (n_e - n_o) / \lambda \quad (1.1)$$

$\lambda$  indicates the light wavelength,  $d$  the thickness of double refraction properties.  $n_e$  and  $n_o$  are the refraction indices of extraordinary and ordinary rays, respectively.

Here, the optical path difference  $R$  is called retardation and can be expressed as follows.

$$\delta = \delta \lambda / 2\pi = d (n_e - n_o) \quad (1.2)$$

$R$  is the value of the deviation of two light rays in a double refraction element, converted to mid-air distance; it is expressed in a direct number (147 nm, etc.), a fraction or the multiple ( $\lambda/4$ , etc.) of the used wavelength.

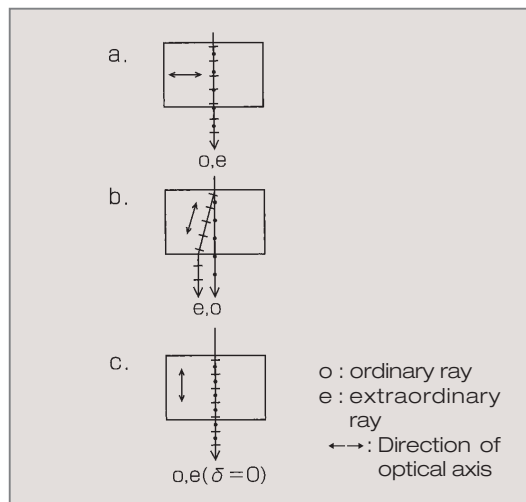

● Fig. 1.9 Relationship between direction of optical axis and double refraction of a crystal ●

## KEYWORD

Optical strain

Photoelasticity

Dichroism

Glan-Thompson prism

Nicol prism

## 1.6 Optical strain

When stress is applied to an isotropic body such as glass or plastic, optical strain occurs, causing the double refraction phenomenon, and that is called photoelasticity. By observing the optical strain of various materials by means of polarization, the stress distribution can be estimated (Fig. 1.10).

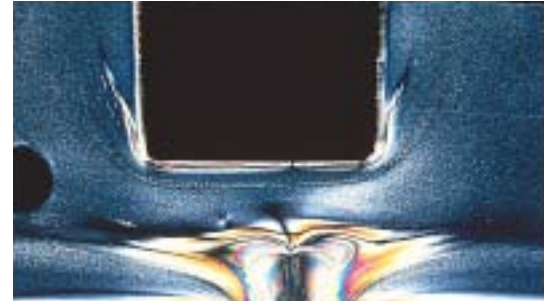

● Fig. 1.10 Optical strain of plastic ●

## 1.7 Light polarizing devices

As stated in 1.2, a polarizing plate and polarizing prism are generally used as the polarizing devices to convert natural light into linearly polarized light. Their respective features are given below.

### (1) polarizing plate

A polarizing plate is a piece of film by itself or a film being held between two plates of glass. Adding salient iodine to preferentially oriented macromolecules will allow this film to have dichroism. Dichroism is a phenomenon in which discrepancies in absorption occur due to the vibration direction of incident light polarization. Since the polarizing plate absorbs the light oscillating in the arranged direction of the macromolecule, the transmitted light rays become linearly polarized. Despite its drawbacks of 1) limited usable wavelength band (visible to near infrared light), and 2) susceptibility to heat, the polarizing plate is inexpensive and is easy to enlarge.

### (2) polarizing prism

When natural light is launched into a crystal having double refraction, the light proceeds in two separate, linearly polarized lights. By intercepting one of these two, the linearly polarized light can be obtained; this kind of polarizing device is called a polarizing prism, and among those we find Glan-Thompson prism (a) and Nicol prism (b).

A polarizing prism has higher transmittance than a polarizing plate, and provides high polarization characteristics that cover a wide wavelength band. However, its angle of incidence is limited and it is expensive. In addition, when used in a polarizing microscope, this prism takes up more space than a polarizing plate and may cause image deterioration when placed in an image forming optical system. For these reasons, a polarizing plate is generally used except when brightness or high polarization is required.

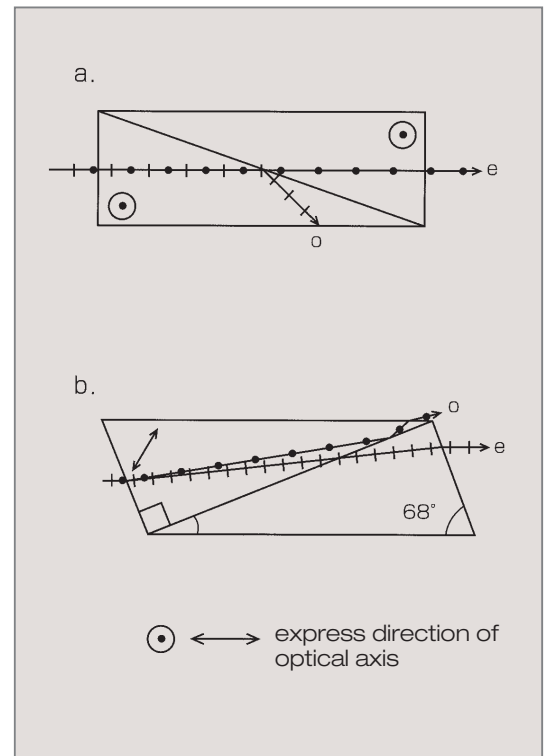

● Fig. 1.11 Polarizing prism ) ●  
(a. Glan-Thompson prism b. Nicol prism)

# 2. Fundamentals of polarized light analysis

## 2.1 Anisotropy in crossed nicols

Light does not transmit in a crossed nicols state, but inserting an anisotropy between a polarizer and an analyzer changes the state of the polarized light, causing the light to pass through. When the optical axis of a crystal with difference of  $d$  is placed between the crossed nicols at an angle of  $\theta$  to the polarizer's vibration direction, the intensity of the injected light is expressed as (2.1).

$$I(\theta) = I_0 \sin^2 2\theta \cdot \sin^2 \left( \frac{\delta}{2} \right) = I_0 \sin^2 2\theta \cdot \sin^2 \left( \frac{\pi R}{\lambda} \right) \quad (2.1)$$

$I_0$  is the intensity of transmitted light during parallel nicols, and  $R$  is the retardation (equation (1.2)). With this equation, the change in brightness during the rotation of an anisotropy and of the interference color from retardation can be explained.

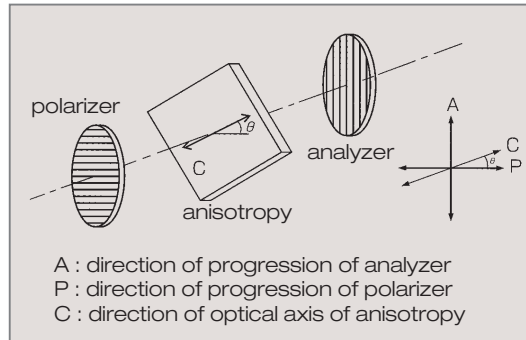

● Fig. 2.1 Anisotropy between crossed nicols ●

### 2.1.1 Change in brightness when rotating anisotropy

As the equation 2.1 signifies, at certain four positions, (90 degrees apart from each other), the anisotropy appears black as its optical axis matches with or becomes perpendicular to the vibration direction. Such positions are called the extinction positions. The brightest position, also known as the diagonal position, is at a 45°. The drawings in Fig. 2.2 represent the change in brightness from extinct to diagonal position and vice versa, while rotating the body.

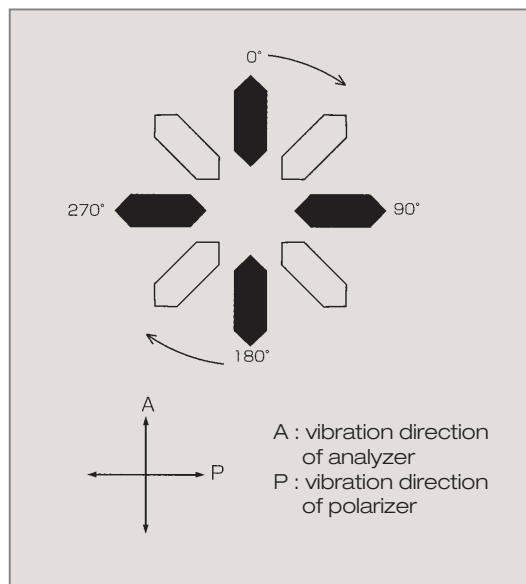

● Fig. 2.2 Extinction position and diagonal position of anisotropy ●

KEYWORD

Extinction position

Diagonal position





## 2.Fundamentals of polarized light analysis

### KEYWORD

Addition

Subtraction

Figure 2.5 shows the transmittance curve of the interference color in relation to retardation around the sensitive color, and is calculated from equation (2.1). In the sensitive colors, green light cannot be transmitted and thus appears as purplish-red (Fig. 2.5b). If retardation is reduced from sensitive colors, then a wide-range mixed color light from green to red turns up, observed as yellow, as shown in Fig. 2.5a; increased retardation, contrarily, brings out a blue interference color. (Fig. 2.5c.)

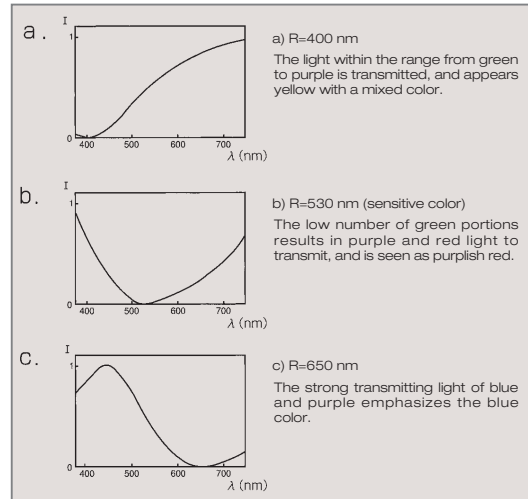

● Fig. 2.5 Retardation and transmittance curve ●

### 2.2 Superimposing anisotropy

Now we consider two anisotropy overlapping one another; one with the vibration directions of their slower light rays ( $Z'$  direction) in the same direction (Fig. 2.6a), and the other perpendicularly. (Fig. 2.6b).

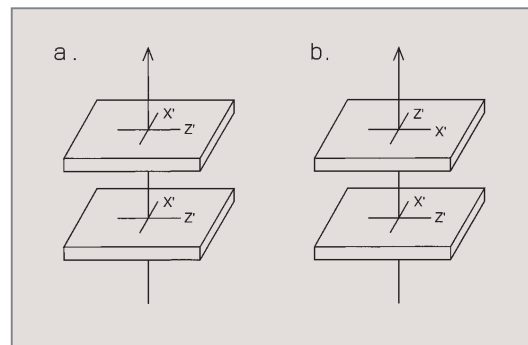

● Fig. 2.6 Superimposing anisotropy ●  
a: addition b: subtraction

When the  $Z'$  directions of two anisotropy overlap, pointing the same direction, the vibration directions of the slower polarized light match. The total retardation is equivalent to the numerical sum of the retardations.

$$R=R_1+R_2 \quad (R_1, R_2 \text{ denote the retardations of anisotropy 1 and 2})$$

This state is called addition (Fig 2.5a). In contrast the phase difference after passing through one anisotropic element is cancelled out by the other phase difference. As a result, the total retardation is the difference between the two anisotropy retardation.

$$R=R_1-R_2.$$

This state is called subtraction (Fig 2.5b). Whether the state is addition or subtraction can be deter-

mined from the changes in the interference color when the anisotropy overlap. Shifting of the interference color toward the increase of retardation is addition, and vice versa for subtraction. Both addition and subtraction are the determinants for judging  $Z'$  direction. (To be discussed further in 4.1.3) Knowing the  $Z'$  direction helps determine the optical character of elongation (see 2.3) In addition, when the anisotropy overlap with one at the extinction position and the other at the diagonal position, the total retardation becomes equivalent to the retardation of the anisotropy at the diagonal position.

## 2. Fundamentals of polarized light analysis

### KEYWORD

Optical character of elongation

Slow length

Fast length

Phase plate

Tint plate

Quarter-wave plate

Half-wave plate

Mica

### 2.3 Optical character of elongation

Some anisotropy are elongated in some direction as the narrow crystals and fibers in rock would be. The relationship between the direction of elongation and  $Z'$  direction can specify the optical character of elongation (zone character). When the  $Z'$  direction matches the direction of elongation, it is said to have a slow length, and when the  $Z'$  direction crosses the direction of elongation, then it has a fast length).

This optical character does not coincide with the positive and negative attributes of uniaxial and biaxial crystals. The optical character of elongation is fixed for anisotropy such as crystals (e.g., uric acid sodium crystals of gout), and, by using a polarizing microscope, can be distinguished from pseudo gout crystals (see 4.1.3).

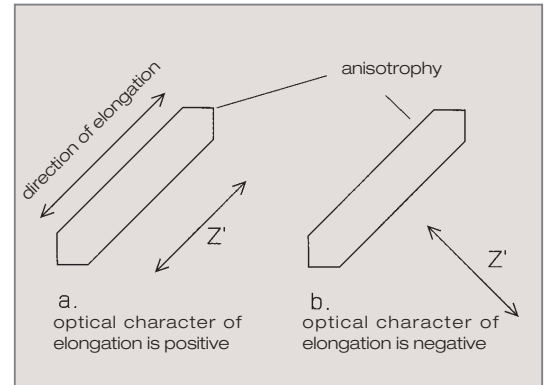

● Fig. 2.7 Optical character of elongation ●

### 2.4 Phase plate

A phase plate is used in the conversion of linearly polarized light and circularly polarized light, and in the conversion of the vibration direction of linearly polarized light. A phase plate is an anisotropy which generates a certain fixed amount of retardation, and based on that amount, several types of phase plate

(tint plate, quarter-wave plate, and half-wave plate) are made. When using a quarter-wave plate, a diagonally positioned optical axis direction can convert incident linearly polarized light into circularly polarized light and vice versa (Fig. 2.8).

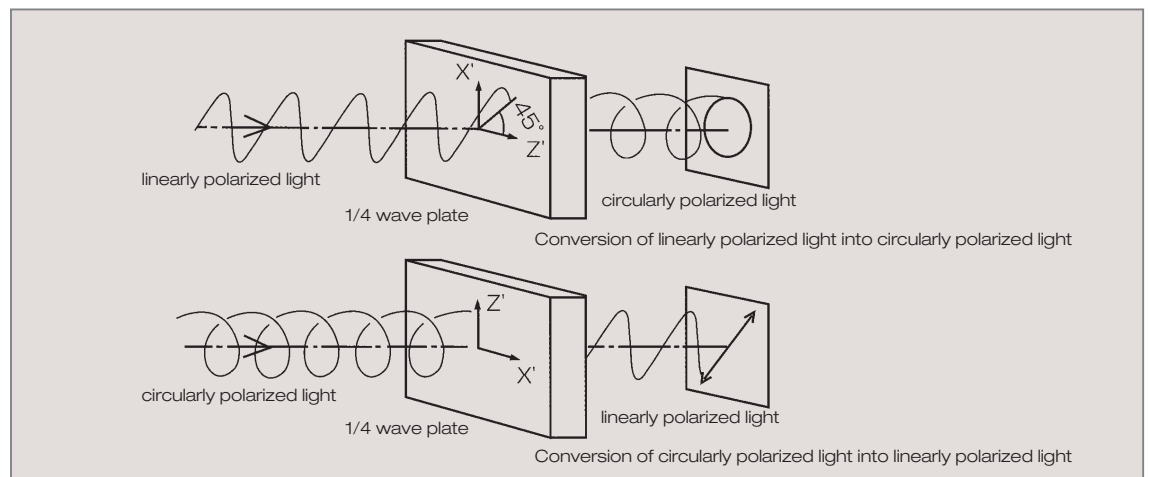

● Fig. 2.8 Quarter-wave plate conversion of linearly polarized light into circularly polarized light ●

A half-wave plate is mainly used for changing the vibration direction of linearly polarized light, and for reversing the rotating direction of circularly polarized and elliptically polarized light. Quarter-wave

plates, half-wave plates, and tint plates are usually thin pieces of mica or crystal sandwiched in between the glass.

# 3. Polarizing microscopes

## 3.1 Characteristics of a polarizing microscope

A polarizing microscope is a special microscope that uses polarized light for investigating the optical properties of specimens. Although originally called a mineral microscope because of its applications in petrographic and mineralogical research, in recent years it has now come to be used in such diverse fields as biology, medicine,

polymer chemistry, liquid crystals, magnetic memory, and state-of-the-art materials. There are two types of polarizing microscopes: transmitted light models and incident light models. Fig. 3.1 shows the basic construction of a transmitted light polarizing microscope.

### KEYWORD

Polarizing microscope

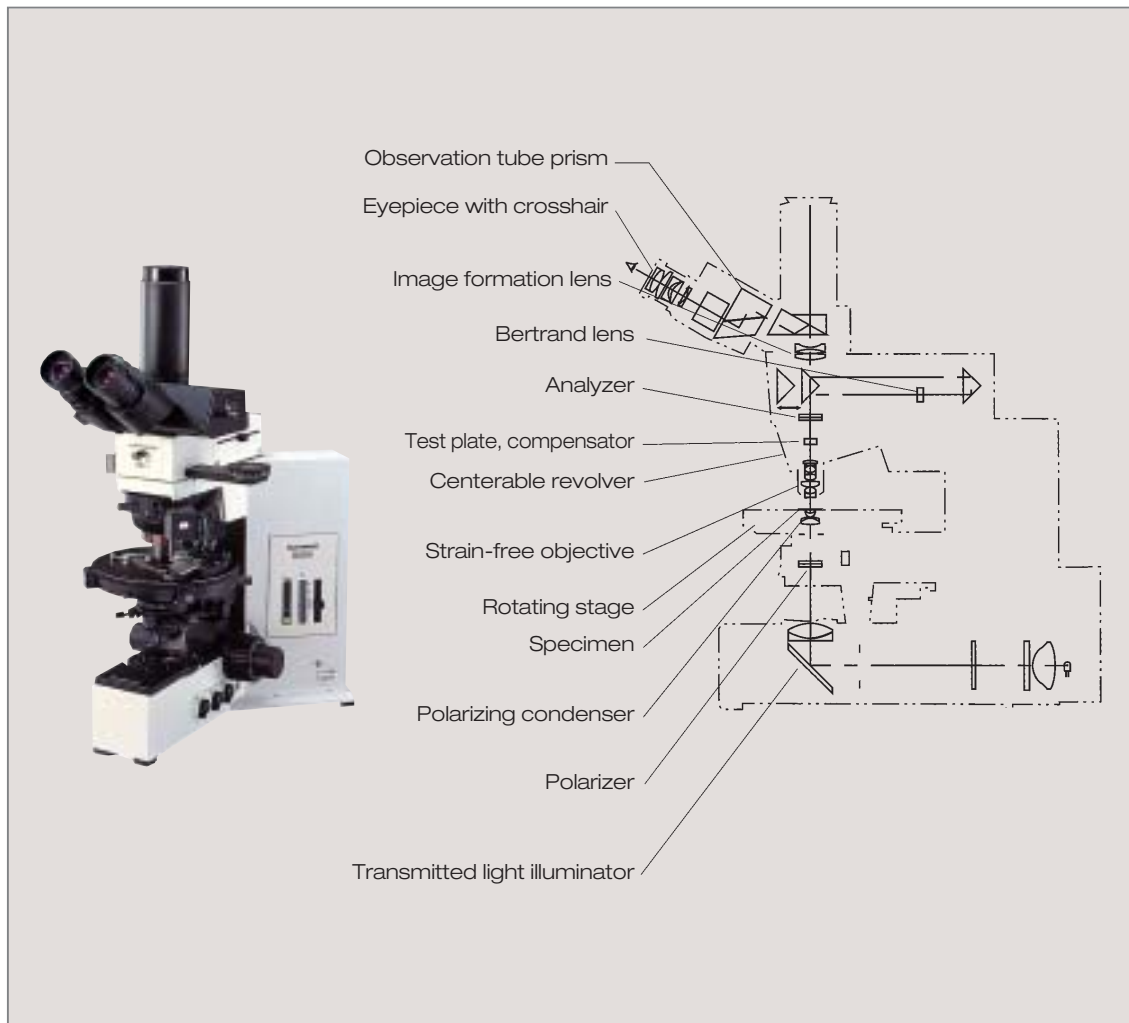

● Fig. 3.1 External view and construction of a transmitted light polarizing microscope (BX-P) ●

## KEYWORD

Polarizing condenser

Rotating stage

Strain-free objective

Centerable revolver

Bertrand lens

Test plate

Eyeiece with crosshair

As seen in Fig. 3.1, compared to a typical microscope, a polarizing microscope has a new construction with the following added units: a polarizing condenser that includes a polarizer, a rotating stage that allows the position of the specimen to be set, a strain-free objective for polarized light, a centerable revolving nosepiece that allows optical axis adjustment for the objective, an analyzer,

a Bertrand lens for observing the pupil of the objective, a test plate, a compensator, and an eyepiece with crosshair. An incident light polarizing microscope like the one shown in Fig. 3.2 is used for the observation of metallic and opaque crystals.

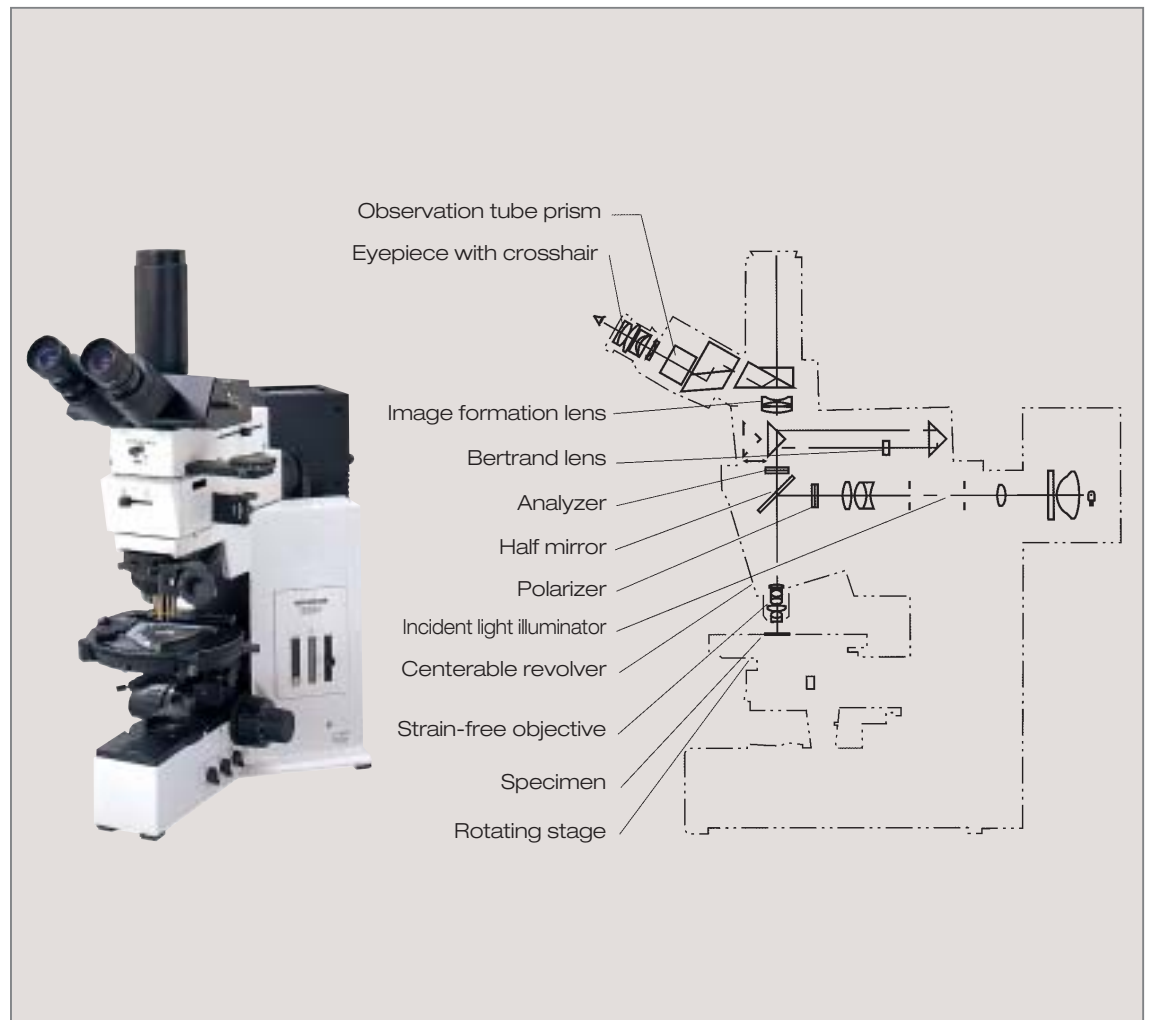

● Fig. 3.2 External view and construction of an incident light polarizing microscope ●

## 3. Polarizing microscopes

KEYWORD

### 3.2 Constituents of a polarizing microscope

#### 3.2.1 Polarizer and analyzer

Among the essentials for polarized light observation, for a transmitted light polarizing microscope, the polarizer should be placed below the condenser and the analyzer should be above the objective. For an incident light polarizing microscope, the polarizer is positioned in the incident light illuminator and the analyzer is placed above the half mirror.

The polarizer is rotatable 360° with degree gradations indicated on the frame. The analyzer can also rotate 90° or 360°, and the angle of rotation can be figured out from gradations as well. As fig. 3.3 shows, the vibration direction of a polarizer should go side to side relatively to the observant, and go vertically for an analyzer. (ISO/DIS 8576)

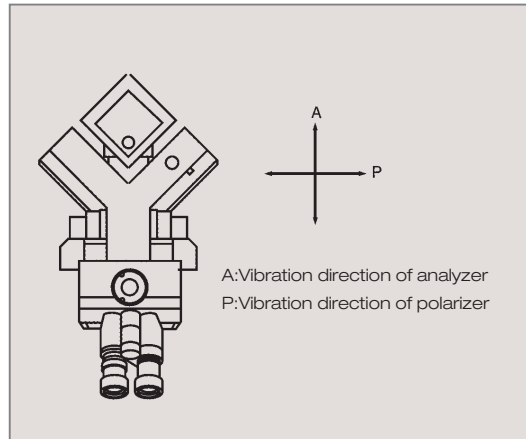

● Fig. 3.3 Vibration direction of light polarizing devices ●

#### 3.2.2 Polarizing objective (strain-free objective)

A polarizing objective differs from ordinary objectives in a respect that it possesses a high light-polarizing capability. A polarizing objective can be distinguished from ordinary ones by the label P, PO, or Pol. Objectives which have the label DIC or NIC signify their use for differential interference, and yet have improved polarization performance. The polarizing objectives can easily be adopted for bright field observation, too.

There are two factors which determine the level of the objectives' polarizing performance: 1) the turbulence of polarizing state, caused by the anti-refraction coating of lenses, or the angle of incidence influencing the refraction on the lens surface, and 2) a lens strain such as an original lens strain, newly created from the junction of the lenses, or from the connection of frame and lenses etc. An objective lens for polarization is designed and manufactured to have low turbulence by refraction in the polarizing state on the lens surface and to have low lens strain.



● Fig. 3.4 Polarizing objective ●  
(ACH-P series and UPLFL-P series)

## KEYWORD

Polarizing condenser

Cross moving device

Rotating stage

Universal stage

Bertrand lens

### 3.2.3 Polarizing condenser

A polarizing condenser has the following three characteristics: 1) built-in rotatable polarizer, 2) top lens out construction when parallel light illumination at low magnification is required, and 3) strain-free optical system, like the objectives.



● Fig. 3.5 Polarizing condenser (U-POC) ●

### 3.2.4 Polarizing rotating stage

As illustrated in 2.1.1, rotating an anisotropy between crossed nicols changes the brightness. For this reason, in polarized light observation, the specimen is often rotated to the diagonal position (the position where the anisotropy is brightest). In other words, rotatability of the polarizing stage and centerability are fundamental (see 3.3).

360° angle gradations are indicated in the area surrounding the rotating stage, and, using the vernier scale, the angle can be measured to an accuracy of 0.1°. A cross moving device is also equipped exclusively for moving specimens.

A universal stage with multiple rotating axes may also be used to enable the observation of specimen from many directions.



● Fig. 3.6 Polarizing rotating stage (U-SRP) ●

### 3.2.5 Bertrand lens

A Bertrand lens projects an interference image of the specimen, formed in the objective pupil, onto the objective image position (back focal length). It is located between the analyzer and eyepiece for easy in and out of the light path. See 4.2 for how to use the lens.

## 3. Polarizing microscopes

### 3.2.6 Centerable revolving nosepiece

The optical axis of the objective changes slightly according to the lens. Since the stage needs to be rotated for polarizing observation, the objective and the optical axis of the tube must coincide exactly with one another. In order for the optical axis to completely match even when the lens' magnification is changed, a revolver with optical centering mechanism is installed in each hole. (see 3.3).



● Fig. 3.7 Centering revolving nosepiece (U-P4RE) ●

### 3.2.7 Eyepiece with crosshair

This is an eyepiece with a diopter correction mechanism which has a built-in focusing plate containing a crosshair. By inserting the point pin into the observation tube sleeve, the vibration direction of the polarizer and analyzer can be made to agree with the crosshair in the visual field.

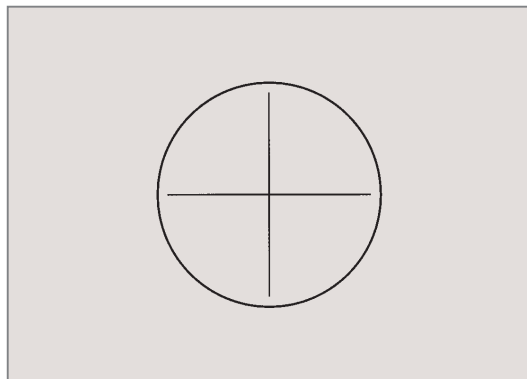

● Fig. 3.8 Crosshair ●

### 3.2.8 Test plate and compensator

The test plate is a phase plate used for verifying the double refractivity of specimens, determining the vibration direction of pieces, and for retardation measurement; a quarter-wave plate ( $R=147$  nm) or a tint plate ( $R=530$ ) are some examples. The  $Y$  direction shown on the test plate indicates the  $Z'$  direction.

The compensator is a phase plate that can change and measure the retardation. See Chapter 5 for more details.

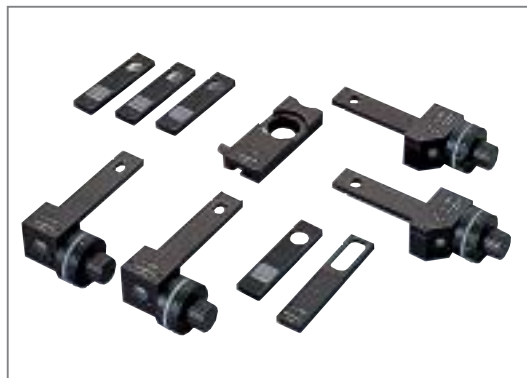

● Fig. 3.9 Test plate with compensator ●

#### KEYWORD

Centerable revolving nosepiece

Eyepiece with crosshair

Test plate

Compensator

$Y$  direction

## KEYWORD

### Orientation plate

## 3.3 Preparation for polarizing microscope observation

In polarized light microscopy, always perform the optical adjustments, e.g. centering of the rotatable stage, adjusting the optical axis of objective lens and vibration direction of a polarizer, before the observation.

### (1) Adjusting the stage

In a polarizing microscope, the stage is often rotated during observation. Thus, it is necessary that centering of the rotatable stage is in alignment with the optical axis of the objective. Insert a standard objective (normally 10x) into the optical path and rotate the stage. Manipulate the two stage centering knobs to bring the center of a circle, which is traced by a point on a specimen on the stage to align with the intersection of the crosshair of the eyepiece. (Fig. 3.10).

### (2) Adjusting the optical axis of the objective

For standard objectives, as explained in (1) above, the centering of the rotating stage aligns with the optical axis of the objective. For objectives with other magnifications, the centerable revolving nosepiece adjusts the centering of the objective optical axis.

For objectives other than 10x, insert the objective into the light path. Then, rotate the stage and turn the screw of the centerable revolving nosepiece to make the optical axis align with the rotating center of the stage.

### (3) Adjusting the polarizer

When the calibration of the polarizer is  $0^\circ$ , the vibration direction must correctly align with the crosshair in the visual field. To do this, an orientation plate, which is a crystal specimen whose optical axis is parallel to the standard plane, is used. If the vibration direction of the polarizer is not in alignment with this optical axis, the orientation plate appears bright. In order to darken it, adjust the polarizer and analyzer and fix them at the position where the standard plane of the orientation plate is parallel with the horizontal line of the crosshair (Fig. 3.11). For some polarizing microscope, the analyzer is already built into the mirror unit and its vibration direction is controlled.

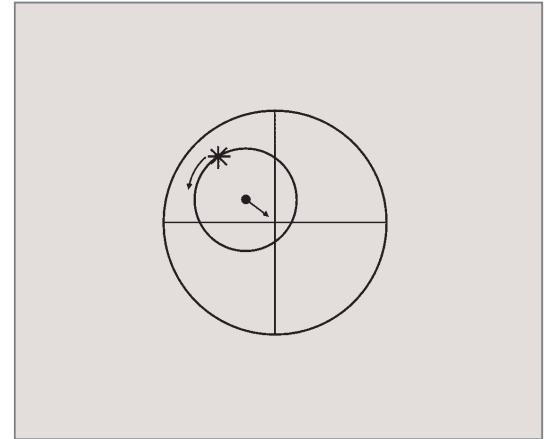

Fig. 3.10 Centering adjustment of the stage

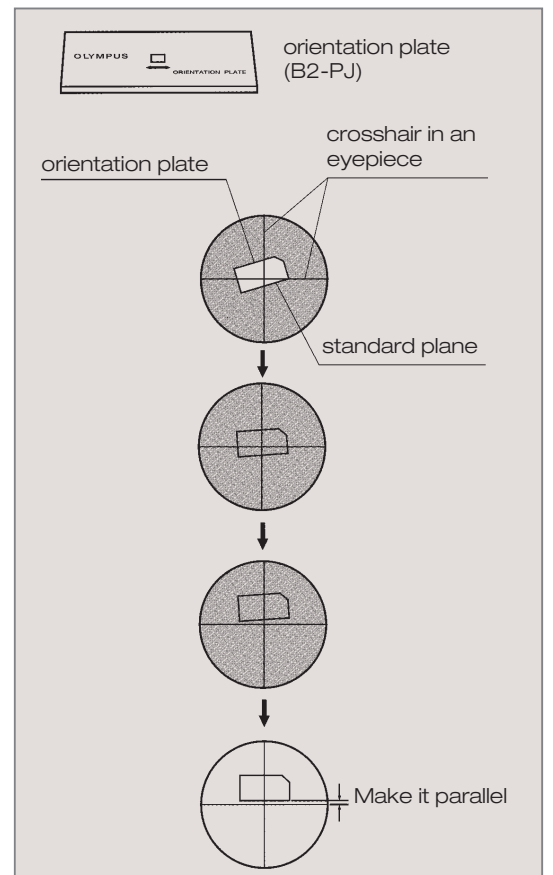

Fig. 3.11 Adjustment by the orientation plate



### 3.Polarizing microscopes

#### KEYWORD

Orthoscope

One nicol

Observation of an anisotropy by a polarizing microscope is generally done with illumination of lower NA but without the top lens of the ordinary condenser lens. This observation is called orthoscopic observation. In order to investigate the optical properties of a crystal, etc., interference fringes that appear on the exit pupil of the objective can be observed during polarizing light observation. This observation method is called conoscopic observation. Provided below are the orthoscopic and conoscopic observation methods.

#### 4.1 Orthoscopic observation

Among the observation methods of a polarizing microscope, the orthoscopic observation is the one in which only the roughly vertical light is exposed to the specimen surface (i.e., low illumination light of NA), and the optical properties are observed only in that direction. In orthoscopic observation, the Bertrand lens is removed from the light path, and either the top lens of the condenser lens is out, or the aperture diaphragm is closed.

There are two orthoscopic observations, one is crossed nicols and the other is one nicol. In crossed nicols, the polarizer and analyzer are both used to be crossed, while in one nicol, only the polarizer is used.

##### 4.1.1 Observation of anisotropy via crossed nicols

The most commonly used observation method in polarizing microscope is crossed nicols observation to inspect the double refractive structures in biology, rock minerals, liquid crystals, macromolecule materials, anisotropic properties such as emulsions, and stress strain.



a) Vitamin crystal

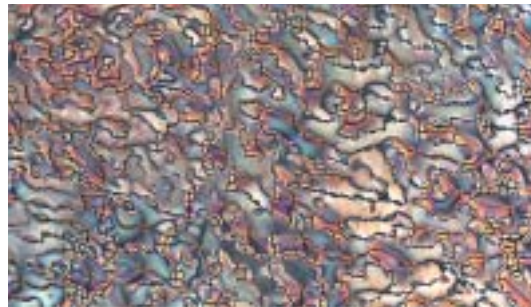

b) Optical pattern of liquid crystal



c) Rock

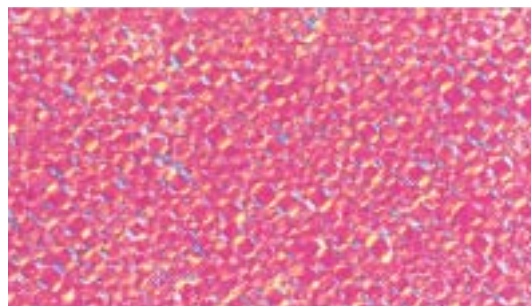

d) Emulsion

● Fig. 4.1 Example of anisotropy observation via crossed nicols ●

## 4. Observation method for polarizing

### KEYWORD

### 4.1.2 General principles of interference colors and retardation

Retardation testing is conducted for investigating an optical anisotropy. Retardation  $R$  is expressed by the equation (1.2) as  $d(n_e - n_o)$ , the product of the width of anisotropy and double refraction. By using this equation, the specimen's double refraction can be calculated from the value of thickness  $d$ , giving a hint as to what the anisotropy may be. If, on the other hand, the value for double refraction is already given, then the thickness  $d$  will be figured out. Furthermore, through the computation of optical strains, the analysis of stress can possibly be made.

In order to determine the retardation, set the

specimen diagonally in crossed nicols, observe the interference colors, then compare it with the interference color chart given in 2.1.2. However, a high degree of accuracy cannot be expected from the retardation value derived in this way; measurement is restricted to the range of bright colors, from primary order to secondary order. This is why a compensator as outlined in Chapter 5 must be used in order to perform accurate measurements.

### 4.1.3 How to use a test plate

The test plate for a polarizing microscope is used as follows:

#### (1) Sensitive color observation

Use of a tint plate in polarization observation of anisotropy with small retardation enables observation at bright interference colors. In the neighborhood of sensitive colors, the retardation changes, and the interference colors alter accordingly but only more sharply and dramatically. Because of its sensitivity, any minute retardation can be detected through interference colors.

#### (2) Measurement of optical character of elongation

As stated in 2.3, measuring the optical character of elongation for anisotropic elements elongated in a certain direction enables to identify the unknown anisotropy. Determining the optical character of elongation is performed while using the test plate and compensator to observe changes in the interference colors (Fig. 4.2).

(a) Set the anisotropy in the diagonal position. Look over the interference color of the specimen in the interference color chart.

(b) Insert the test plate into a slot and observe the changes in the interference colors. If the color converts to higher order, then the  $Z'$  direction of the anisotropy matches the  $Z'$  direction of the test plate. If it changes to lower order, the  $Z'$  direction is perpendicular to that of test plate. Relationship between the direction of elongation and  $Z'$  direction of the anisotropy helps determine the optical character of elongation.

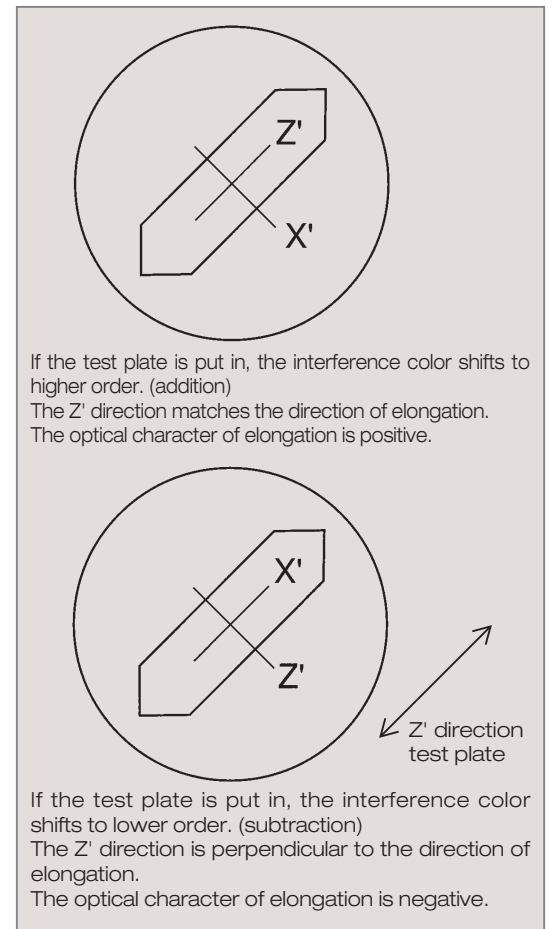

● Fig. 4.2 Determination of the optical character of elongation ●

#### 4.1.4 One nicol observation

One nicol observation, in which the analyzer is removed from the optical path, leaving the polarizer inside, is mainly used to observe rock minerals. In crossed nicols observation, the anisotropy appears colored by the interference colors. However, because interference colors do not emerge with only one nicol, the specimen can be seen in more natural, original color. Besides inspecting the shape, size, and color of the specimen, investigation of pleochroisms by rotating the stage and observing the changes in colors can be done.

To estimate the index of refraction of crystals such as minerals, Becke line is often utilized. The Becke line is a bright halo visible between the crystal and the mounting agent when the aperture stop of the condenser lens is closed (Fig. 4.3). The Becke line is clearly visible when the difference of the index of refraction of the mounting agent and the crystal is large; it becomes dim when the difference is small.

Lowering the stage (or raising the objective) moves the Becke line to a higher index of refraction, and raising the stage (or lowering the objective) moves the line to a lower index of refraction. By changing the mounting medium while observing the Becke line, the medium having the same index of refraction with the crystal can be determined, and in turn, the crystal's index of refraction can be deduced.

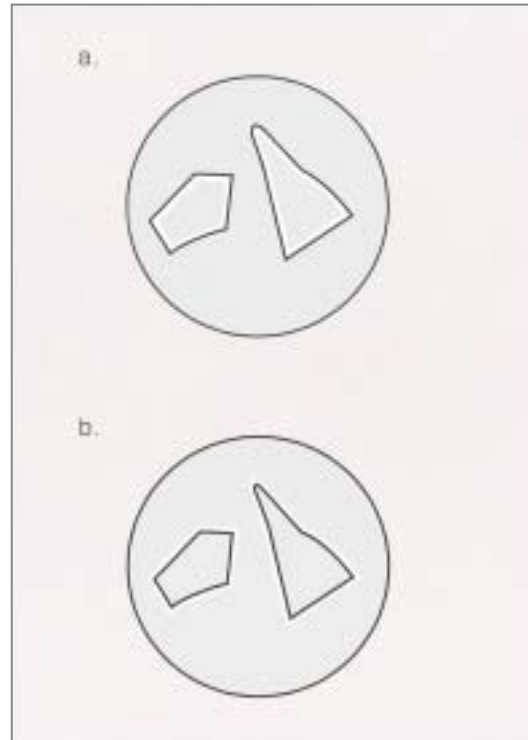

● Fig. 4.3 Becke line ●

When the index of refraction of the crystal is greater than the index of refraction of the mounting agent:

- a) Becke line with a slightly lowered stage
- b) Becke line with a slightly raised stage

In the opposite case, the location of the Becke line is contrary to what is seen in Fig 4-3.

## KEYWORD

### Conoscope

## 4.2 Conoscope

Conoscopic observation is used to obtain the information necessary for identifying crystals such as rock minerals in uniaxial and biaxial measurement as well as in measurement of the optical axis angle.

### 4.2.1 Conoscopic optical system

Among many observation methods using a polarizing microscope, the one which studies the pupil surface of the objective (back focal plane) with a condenser lens installed is called conoscopic observation. The purpose of conoscope is to view the interference fringes created from the light rays that travels through the specimen through multiple angles, and thus enables the inspection of various optical properties of the specimen in different direction at the same time. In order to gain the best result, the objective lens with NA of high magnification is required.

The Conoscopic optical system is shown in Fig. 4.4. The linearly polarized light that passes through the polarizer is converged by the condenser and travels through the specimen at various angles. After that, the linearly polarized light will be divided into ordinary and extraordinary rays in the crystal, will proceed parallel to each other after passing through the crystal, then possess the optical properties that are peculiar to the specimen, and the retardation dependent of the angle of incidence.

The two rays meet on the pupil surface of the objective and their polarization direction is adjusted by the analyzer, causing an interference. These interference fringes are called the conoscopic image. First interference fringes, created by the rays parallel to the microscope optical axis, emerge at the center of the conoscopic image. The light rays which was launched at an angle relative to the optical axis creates the second interference fringes, which then appear in the periphery of the image.

The conoscopic image can be easily studied by removing the eyepiece. However, because the interference fringes will become rather small, an auxiliary lens called a Bertrand lens projects the pupil surface of the objective onto the original image position, and enlarges it through the eyepiece.

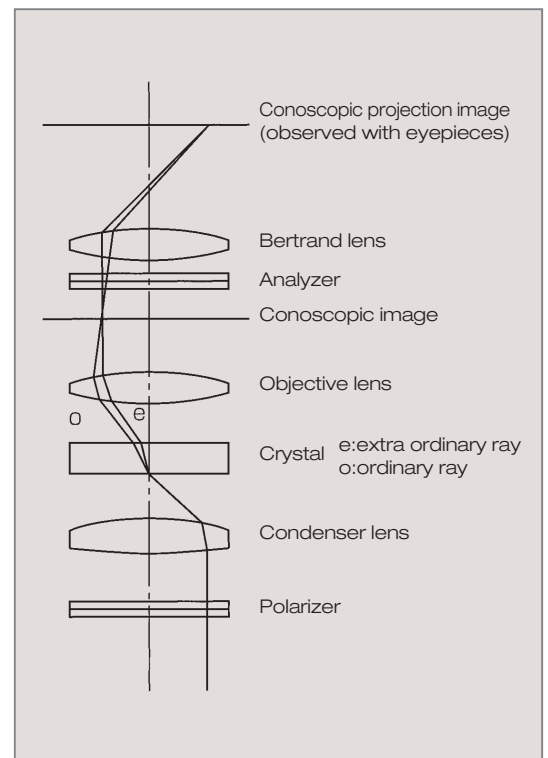

● Fig. 4.4 Conoscopic optical system ●

## 4. Observation method for polarizing microscope

### KEYWORD

Isogyre

### 4.2.2 Conoscopic image of crystals

Conoscopic images of uniaxial crystals differ from those of biaxial crystals. A flake that has been cut vertically by uniaxial optical axis can be viewed as a concentric circle with penetrated black cross (isogyre). This cross center is the optical axis direction of the uniaxial crystal.

As shown in Fig. 4.5b, if an image has two centers of the interference fringes, then the image is for a biaxial crystal. By studying the style of a conoscopic image, the distinction between uniaxial crystals and biaxial crystals, the optical axis direction, the optical axis angle of biaxial crystals, and the positive and negative crystals can be attained.

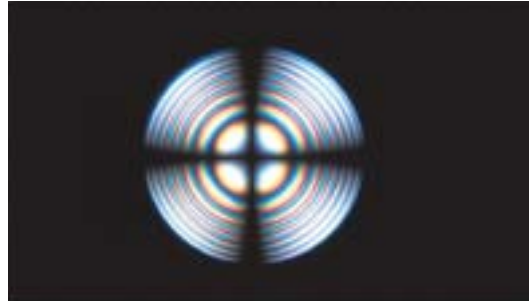

a) Uniaxial crystal conoscopic image (calcite)

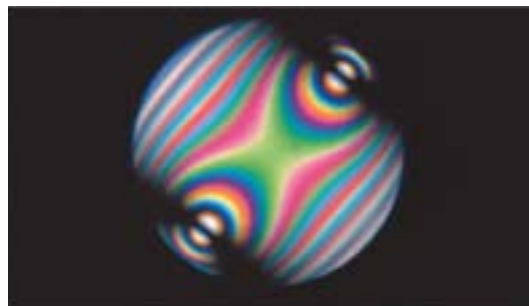

b) Biaxial crystal conoscopic image (topaz)

● Fig. 4.5 Conoscopic images ●

### 4.2.3 Determination of positive and negative crystal using a test plate

The use of a test plate in the conoscopic image enables to distinguish positive and negative crystals. In the case of uniaxial crystals, the vibration direction of the extraordinary rays oscillates inside the principal section (the surface including the vibration direction of the rays and the optical axis), and ordinary rays oscillate perpendicularly to the principal section. For positive crystals, the index of refraction of extraordinary rays is greater than that of the ordinary rays, and vice versa for negative crystals.

As a result, in uniaxial crystals cut perpendicularly by the optical axis, the  $Z'$  direction of the conoscopic image appears as shown in fig. 4.6a. Inserting the test plate into the optical path for a positive crystal changes the interference colors in the direction in which the first quadrant and third quadrant are added. As for a negative crystal, the interference colors move in the direction in which the second quadrant and the fourth quadrant are added. Observing the changes in the interference colors upon inserting the test plate helps determine whether it is a positive crystal or a negative crystal.

Figure 4.6b shows a conoscopic image of the uniaxial crystal when the sensitive color test plate is inserted into the light path. Observing the changes in the interference colors around the optical axis determines whether the crystal is positive or negative.

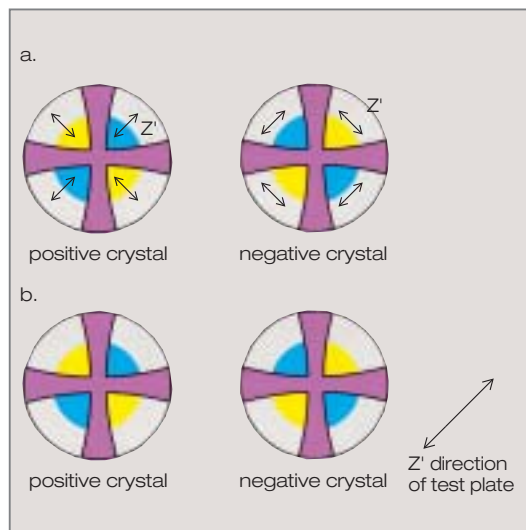

● Fig. 4.6 ●

a) The  $Z'$  direction of the uniaxial crystal conoscopic image  
b) Changes while the sensitive color test plate is present in the light path

# 5. Compensator

## KEYWORD

### Compensator

For strict measurement of the retardation of anisotropy, a device called a compensator, composed of a phase plate that can change the retardation, is used. Depending on the compensators, measurement methods and measurable retardation

vary, thus it is necessary to choose the most suitable compensator for the application. This chapter describes the principles and measurement methods of various compensators.

## 5.1 Types of compensators

The accurate retardation measurement can be obtained by canceling the retardation created from specimens, and by reading the calibration marked at the point. Most typical compensators'

measuring ranges and applications are given below.

Name*	Measuring Range**	Main Applications
Berek U-CTB U-CBE	0-11000nm(0-20 $\lambda$ ) 0-1640nm(0-3 $\lambda$ )	<ul style="list-style-type: none"> <li>• Substances with high retardation such as crystals, LCDs, fibers, plastics, teeth, bones, and hair.</li> <li>• Retardation measurement of optical strain</li> <li>• Determination of the Z' direction of anisotropy</li> </ul>
Sénarmont U-CSE	0-546nm(0- $\lambda$ )	<ul style="list-style-type: none"> <li>• Retardation measurement of crystals, fibers, living organisms, etc.</li> <li>• Retardation measurement of optical strain</li> <li>• Emphasizing contrast for the observation of fine retardation textures</li> <li>• Determination of the Z' direction of anisotropic bodies</li> </ul>
Bräce-köhler U-CBR1 U-CBR2	0-55nm(0- $\lambda$ /10) 0-20nm(0- $\lambda$ /30)	<ul style="list-style-type: none"> <li>• Retardation measurement for thin film and glass</li> <li>• Emphasizing contrast for the observation of fine retardation textures</li> <li>• Determination of the Z' direction of anisotropy</li> </ul>
quartz wedge U-CWE	500-2000nm(1-4 $\lambda$ )	<ul style="list-style-type: none"> <li>• Retardation measurement of rock crystals</li> <li>• Determination of the Z' direction of anisotropy</li> </ul>

● Table 5.1 Measuring range and applications of various compensators ●

\* Compensator names are Olympus brand names

\*\* The measuring range of the compensator is that of an Olympus compensator (compensator measuring ranges vary with manufacturers)

The Z' direction (Y direction) is printed on the compensator to facilitate distinguishing the Z' direction of anisotropy as well as test plate. (see 4.1.3).

Detailed information on each compensator is given next.

## 5.2 Berek compensator

A Berek compensator is a kind of a prism which measures retardation with a calcite or magnesium fluoride crystal cut perpendicular to the optical axis. (Fig. 5.1)

Turning the rotating dial on the compensator inclines the prism relative to the optical axis, lengthens the optical path, and increases the difference between the index of refraction of the ordinary rays and extraordinary rays ( $n_e - n_o$ ), which in turn increases retardation as shown in Fig. 5.2.



● Fig. 5.1 Berek compensator ●

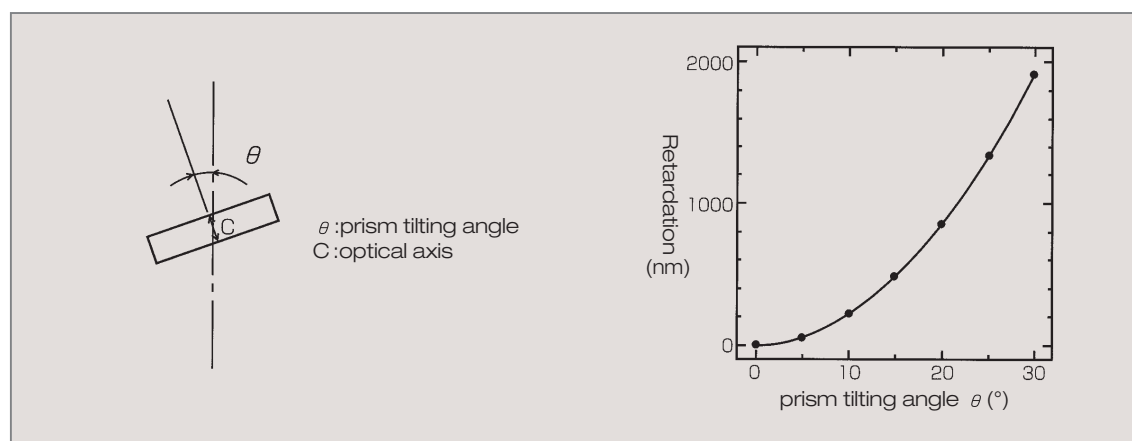

● Fig. 5.2 Angle of prism inclination and retardation of Berek compensator ●

To measure the retardation of specimen, tilt the prism to move the black interference fringes or a dot to the desired location, then read the calibration from the rotation dial (at this point, the retardation of the compensator and that of the specimen become equivalent).

Use the attached conversion table to determine the retardation R from the angle that is read out. The table is derived from calculation using the following equation.

$$R = C \cdot \frac{2 \left| \sqrt{1 - \sin^2 \theta / \varepsilon^2} - \sqrt{1 - \sin^2 \theta / \omega^2} \right|}{(1/\varepsilon^2 - 1/\omega^2)} \quad (5-1)$$

Here, C is calculated as follows:

$$C = \frac{d \cdot \omega}{2} (1/\varepsilon^2 - 1/\omega^2)$$

$\omega$ ,  $\varepsilon$ : refraction indices for ordinary rays and extraordinary rays  
 d: prism thickness of the compensator

**KEYWORD**

Two kinds of Berek compensators are available from Olympus: U-CTB with a large double refractance calcite prism, and U-CBE with a calcite magnesium prism. U-CTB has a wider measuring

range than conventional Berek compensators. The typical interference fringes when using a Berek compensator are shown below.



a) diagonal position

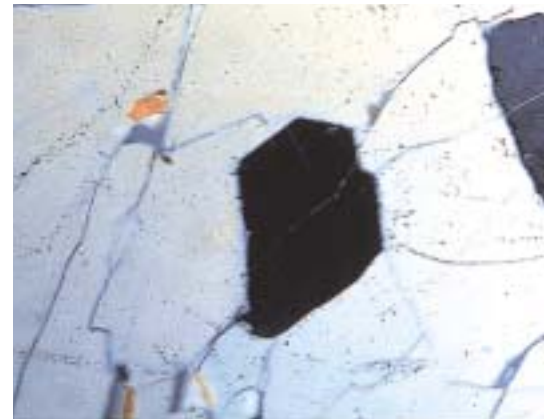

b) while measuring retardation

● Fig. 5.3 Berek compensator interference fringes when measuring minerals inside rocks ●



a) U-CBE



b) U-CTB

● Fig. 5.4 Berek compensator interference fringes when measuring fibers ●

(The above diagram is from a positive fiber. When it is negative, the interference fringes are reversed for U-CBE and U-CTB.)



## 5. Compensator

### 5.3 Sénarmont compensator

A Sénarmont compensator is a combination of a highly accurate quarter-wave plate and a rotating analyzer to measure retardation. The

configuration of the Sénarmont compensator is shown in Fig. 5.6.



● Fig. 5.5 Sénarmont compensator (quarter-wave plate) ●

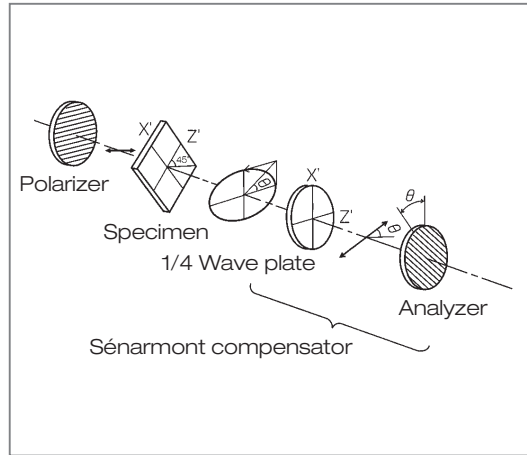

● Fig. 5.6 Sénarmont compensator configuration ●

The rays exited from the specimen whose retardation is measured are elliptically polarized light. Specimen retardation determines the state of this elliptically polarized light. This light becomes linearly polarized when it passes through a Sénarmont compensator (quarter-wave plate). The linearly polarized light at this time is rotated more than when no specimen is present. The retardation of the specimen determines the extent of the rotation. The rotation angle  $q$  is the position at which the specimen is darkened when the analyzer is rotated. The retardation  $R$  is calculated from the rotation angle  $q$  by the following equation:

$$R = \frac{\theta^\circ}{180} \lambda \quad (5.2)$$

Since the quarter-wave plate used in the Sénarmont compensator is normally designed for a 546 nm wavelength, the  $\lambda = 546$  nm narrow band interference filter must be used.

An example usage of the Sénarmont compensator is shown in the picture below.



a) diagonal position



b) while measuring retardation

● Fig. 5.7 Measurement of muscle with Sénarmont compensator ●

## KEYWORD

Sénarmont compensator

**KEYWORD**

Bräce-köhler compensator

### ■ 5.4 Bräce-köhler compensator

A Bräce-köhler compensator is a compensator for measuring fine retardation. (see Fig.5.9) To change the retardation, rotate the small mica prism with low retardation with optical axis in the

center. Turning the dial will rotate the prism.



● Fig. 5.8 Bräce-köhler compensator ●

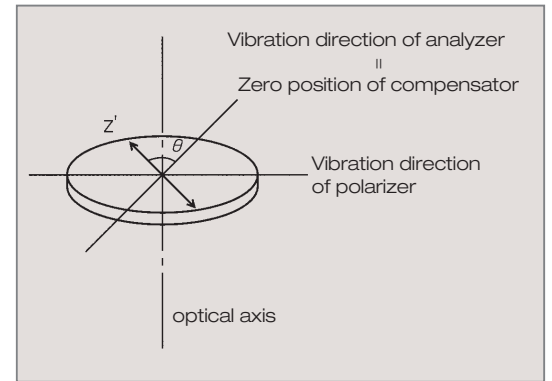

● Fig. 5.9 Bräce-köhler compensator prism (rotation direction) ●

The value of retardation R using a Bräce-köhler compensator can be found from the equation below, using the rotation angle  $\theta$ .

$$R=R_0 \cdot \sin (2 \cdot |\theta|) \quad (5.3)$$

$R_0$  is a constant value individually attached to each product. An example usage of the Bräce-köhler compensator is shown in Fig 5.10.

A Bräce-köhler compensator is also used to increase contrast in polarized light observation, besides retardation measurement. When using a Bräce-köhler compensator to observe a sample with an extremely small retardation, an increase or a decrease of retardation results in stressing the differences in brightness between the place where retardation occurs and its background, and thus simplifies the observation. The Bräce-köhler compensator is particularly effective during observation in polarized light of the double refractive structure in living organisms.

Two Bräce-köhler compensators are available from Olympus: U-CBR1 and U-CBR2. U-CBR1 has a measuring range of 0-55 nm ( $\lambda / 10$ ), and U-CBR2 has 0-20 nm ( $\lambda / 30$ ).

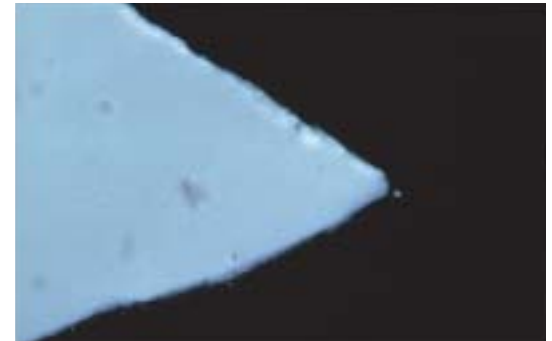

diagonal position



while measuring retardation

● Fig. 5.10 Measurement of a film with Bräce-köhler compensator ●

### 5.5 Quartz wedge

A quartz wedge is shown in Fig. 5.12. Moving the quartz wedge can alter the retardation because the retardation continually changes in the direction of the wedge.

Instructions on how to measure the sample retardation is provided next. Moving the quartz wedge toward the long-side direction makes the black fringes appear when the sample retardation and compensator retardation cancel out each other. At this point, remove the specimen, secure the quartz wedge, and determine the retardation by comparing the observable interference color with the interference color chart. The result obtained in this manner lacks accuracy. Besides measuring retardation, the quartz wedge is also used for determining the Z' direction.



● Fig. 5.11 Quartz wedge ●

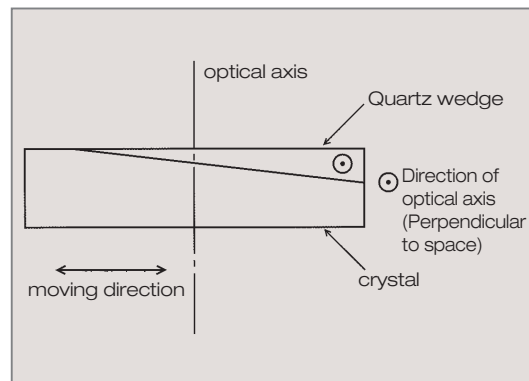

● Fig. 5.12 Quartz wedge prism ●

An example of measuring quartz wedge retardation is shown below.



a) diagonal position



b) while measuring retardation

● Fig. 5.13 Measurement with a mineral crystal quartz wedge. ●

**OLYMPUS**

