



Units and Instruments

Units of measurements:

- Ground distances: m and km
- Map distances: mm and cm

Main Instrument:

- Chain.
- Tape.



إصبع	1/16 قدم عربية	2.25 ~ سم
قبضة	1/4 قدم عربية	9 ~ سم
شبر	الشبر المسافة ما بين أصبع السبابة والابهام .	
قدم عربية		32 ~ سم
ذراع	الذراع :تقليديا 2 أقدام العربية، في وقت لاحق 1.5 أقدام العربية	
خطوة	ذراعين أو 3 أقدام أو 12 كف .	
القامة	6 أقدام عربية	1.92 ~ م
الباع	المسافة التي ما بين اليدين ممدودة ومن إبهام اليد اليمنى إلى إبهام اليد اليسرى .	
جز		25 - 37 بوصة
قصبة	12 قدم عربية	3.84 ~ م
الغلوة	300 إلى 400 ذراع	
فرسخ	الفرسخ 18000 قدم العربية	5.76 ~ كم
بريد	4 فراسخ	23.04 ~ كم
مرحلة	8 فراسخ	46.08 ~ كم

Measuring Chain

- It is made of a series of steel links; each link is the same length, usually 20 cm. The links are attached to each other by steel rings.
- Each meter of the chain is usually marked by a brass ring.
- The total length of the chain is usually 10 or 20 m.
- Chains are less accurate than bands and tapes, but they are much stronger.





Chain handle

At each end of the chain, there is a metal handle which you should include in the measurements.

Length of a link in a chain

The length of one link includes its straight portion, its two rounded ends, and the two half-rings that connect it to the links on either side.

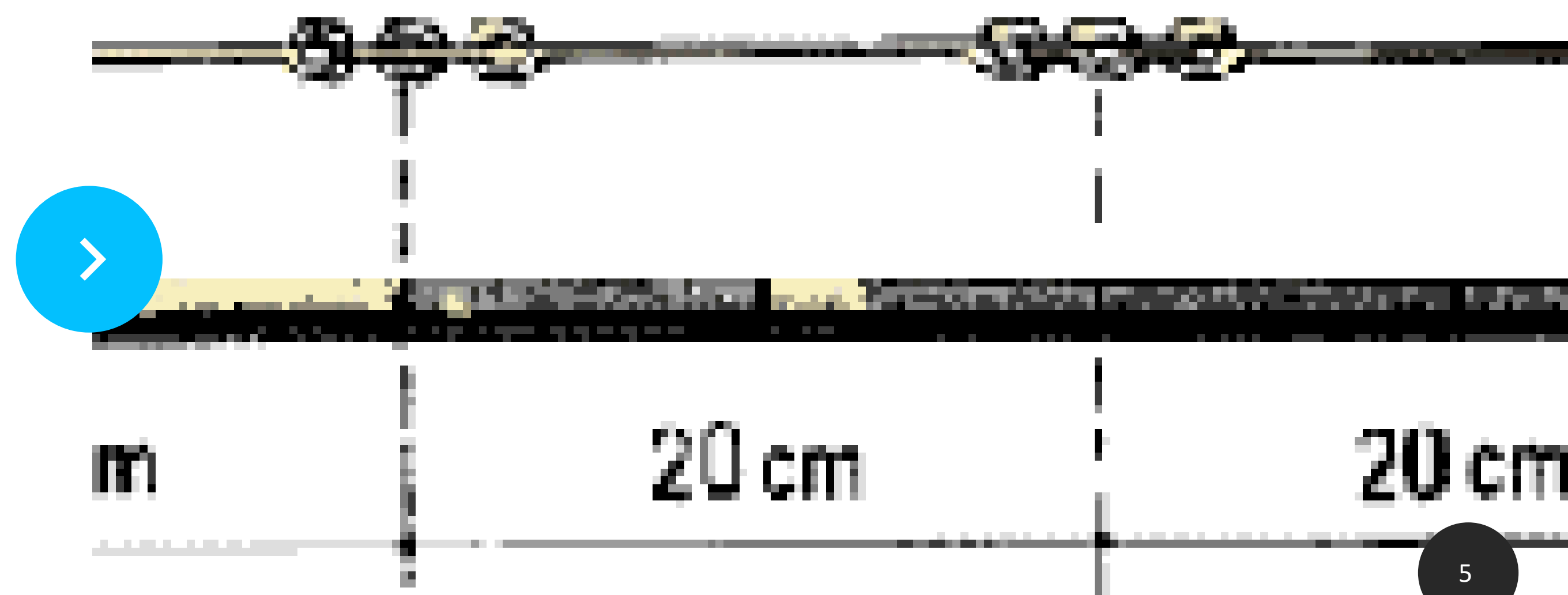

Measuring Tape

- Measuring tapes are made of steel, metallic, cloth (linen) or fibre- glass material.
- They are usually marked at 1 m intervals, graduated in decimetres and centimetres.
- They are wound into a case, with a handle for rewinding.
- Tapes can present some problems:
 - Steel tapes can easily become twisted and break.
 - Cloth tapes are less precise than the others, since they often vary slightly in length.





Pegs

to mark end points of a line.



Poles

for ranging.



Plum bob

to keep tape horizontal and to help
Centering above point



Hand Level or Clinometer

for vertical angle measurement



Marking Pins or Arrows

to count number of tape lengths used



Cross Staff

for dropping or erecting right angles.



Prism Square

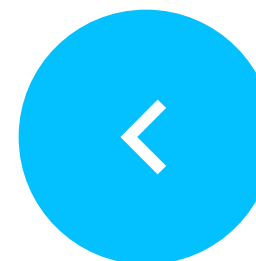

Cross staff

- (a) Open cross staff.
- (b) French cross staff.
- (c) Adjustable cross staff.

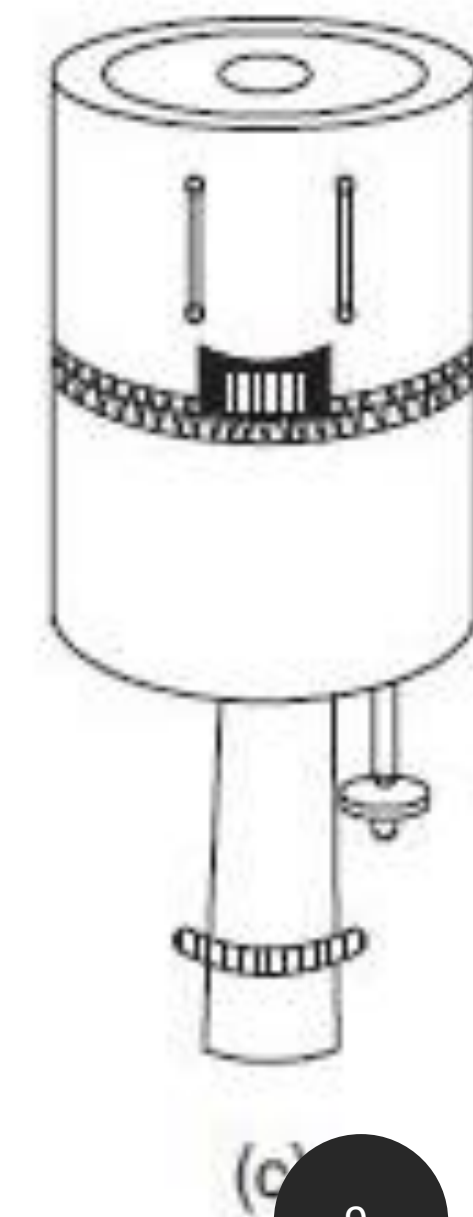
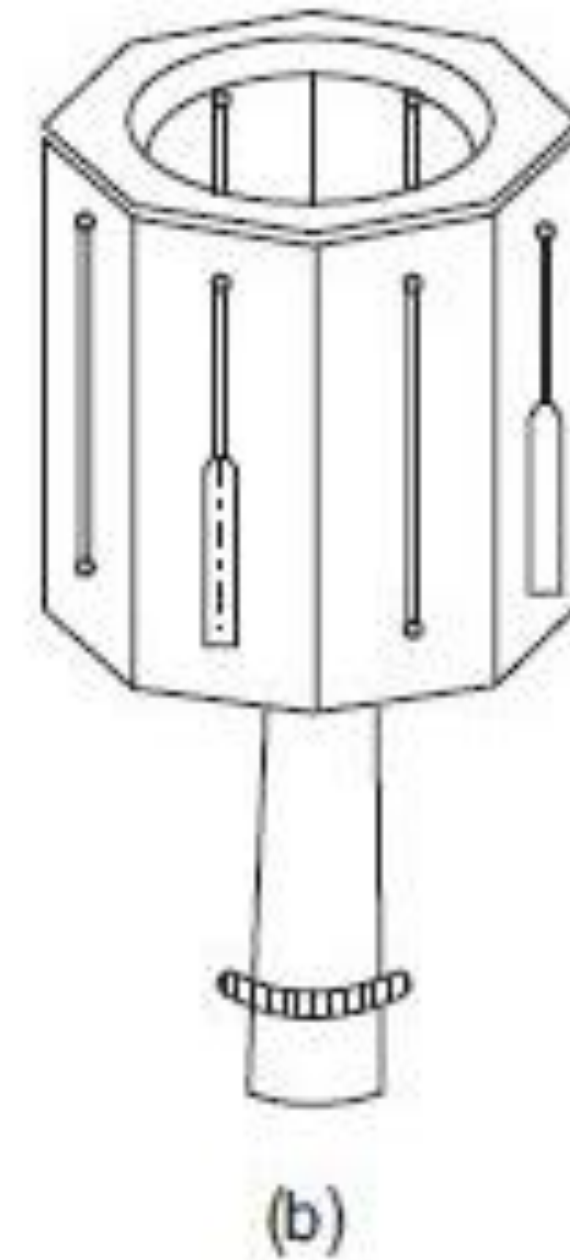
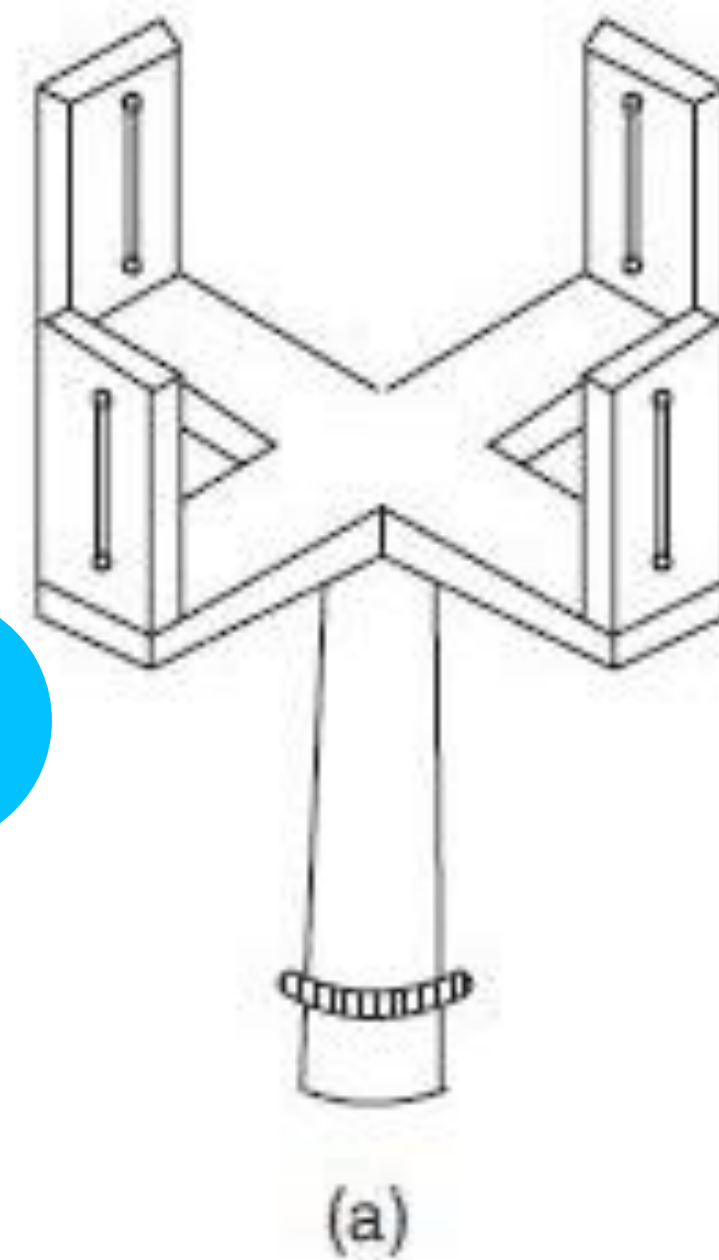
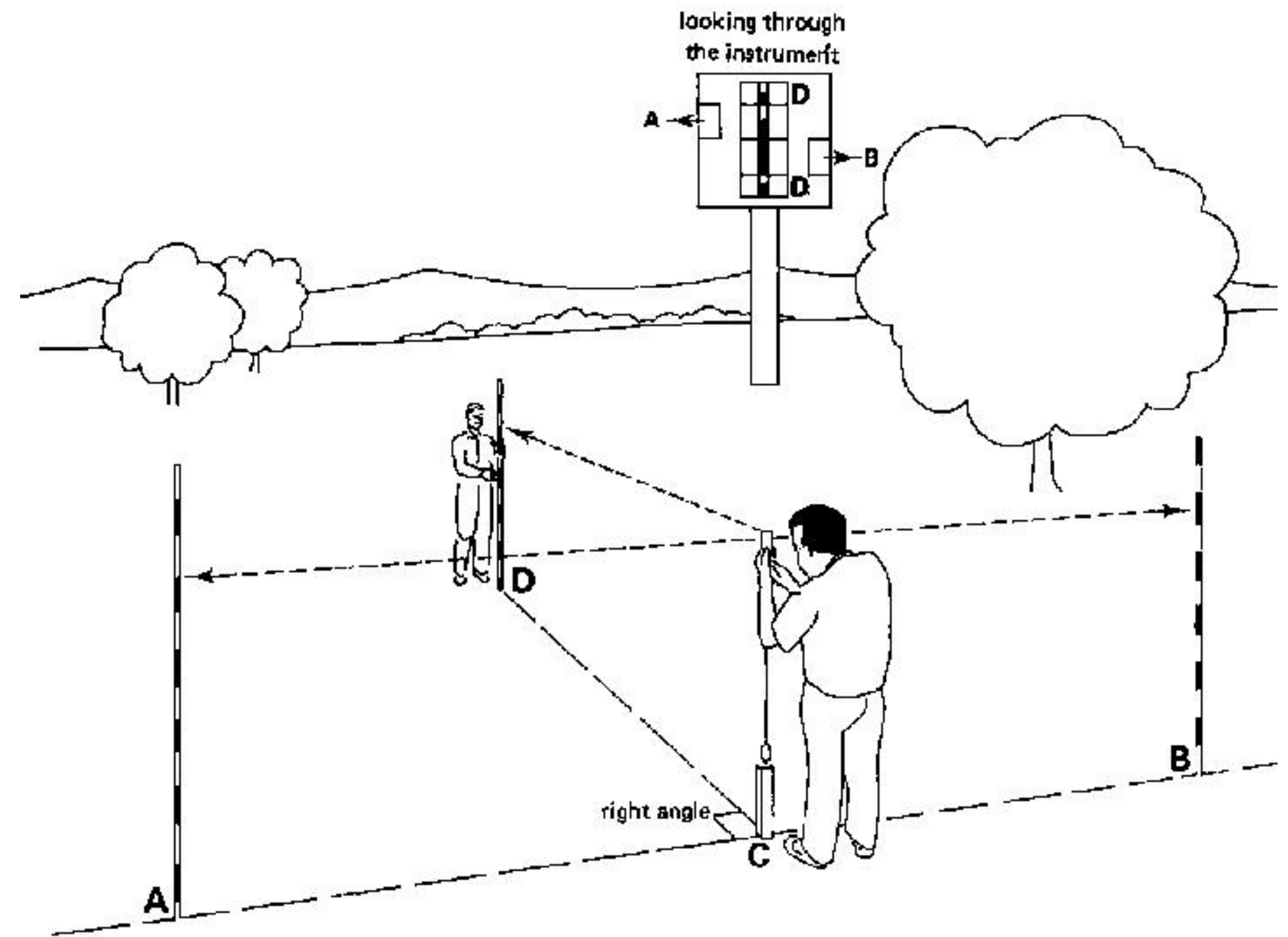
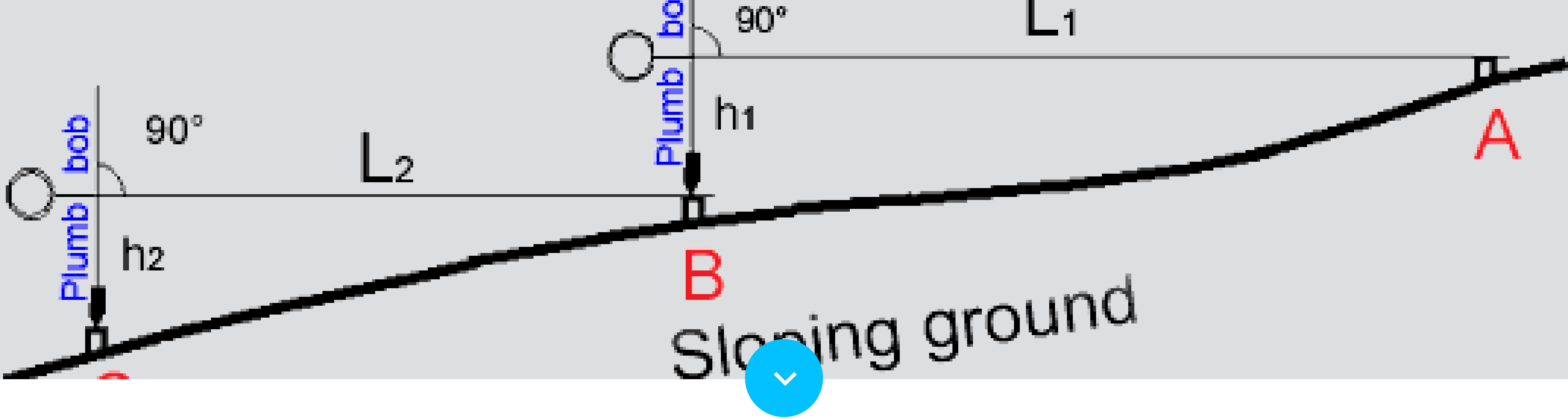

Fig. 12.14 Cross staff

Perpendicular Offset Using Cross Staff





Expressing distances as horizontal measurements

- You should always measure distances as horizontal distances.
- You may have to measure on ground which has no slope, or only a very small slope that is less than or equal to 5 percent. The distance measured on this type of ground will be equal to or very close to the horizontal distance.
- When the slope of the terrain is greater than 5 percent, however, you will have to find the horizontal distance. To do this, you must either correct any measurements you made along the ground or use another method of measurement. Unlevelled ground also requires particular methods of measurement.

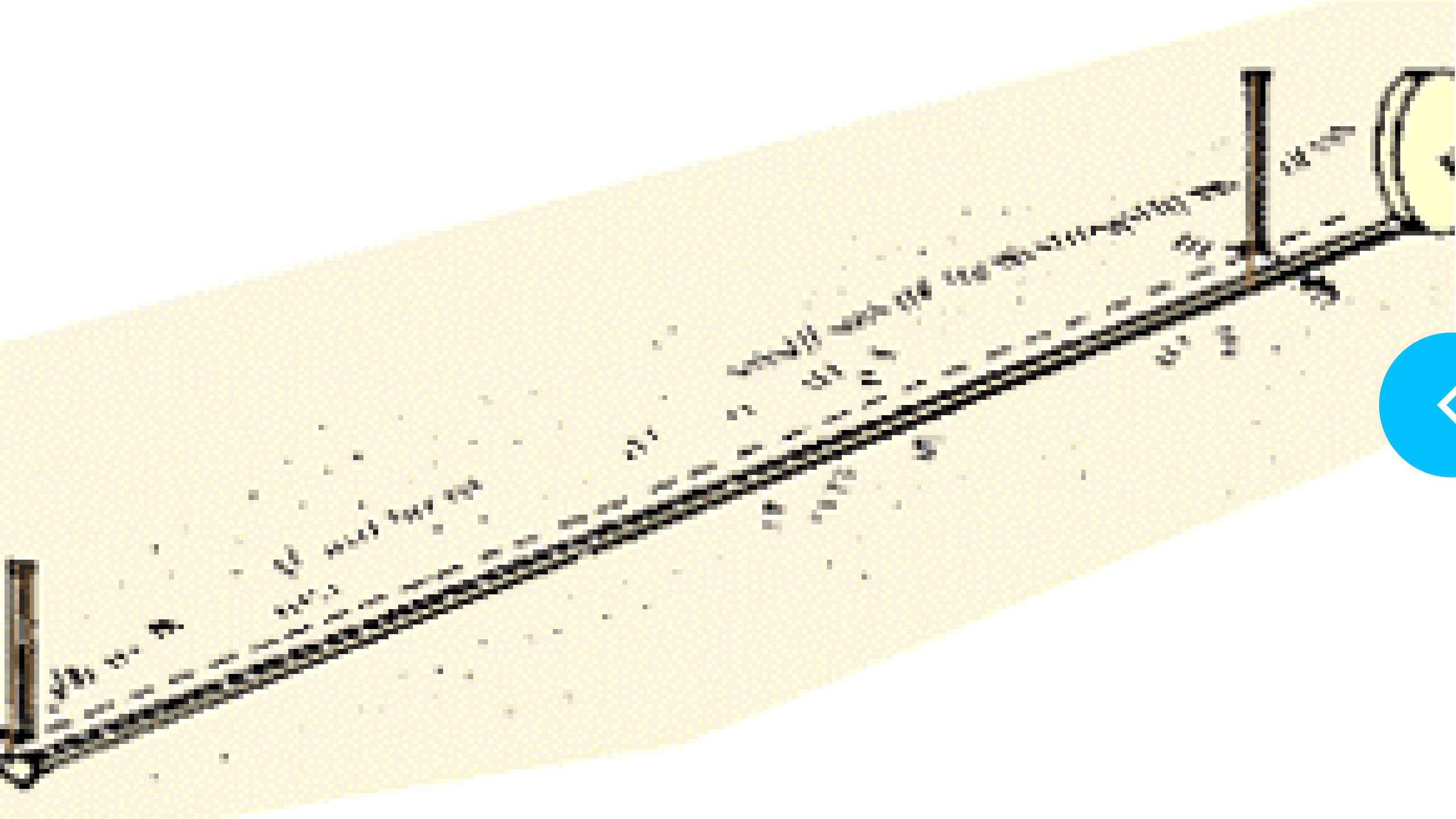

Measuring short horizontal distances with a tape

If the lines are the same length as your measuring band or tape or shorter, you can measure the distances directly. To do this, stretch the band or tape from one peg to the next one.

Keep the tape straight and tight, read at the peg

Note: you should pull bands and tapes tight, so that they do not sag, especially when you are measuring long distances. But, you should avoid over-stretching them (especially fiberglass tapes), since this could lead to errors.

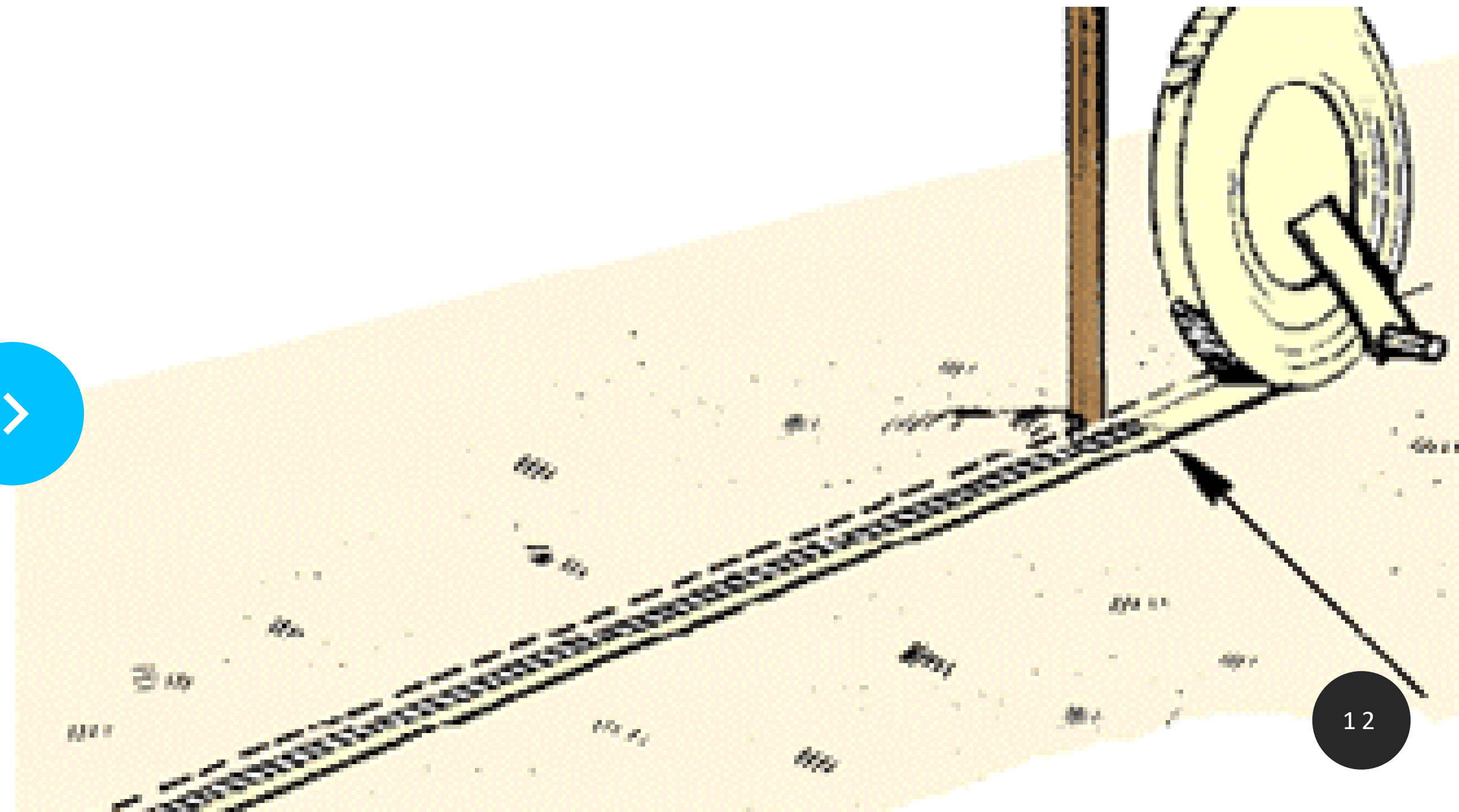

Measuring long distance over horizontal ground

Mark each straight line you need to measure with a ranging pole at each end. On lines longer than 50 m, place intermediate markers at regular intervals.

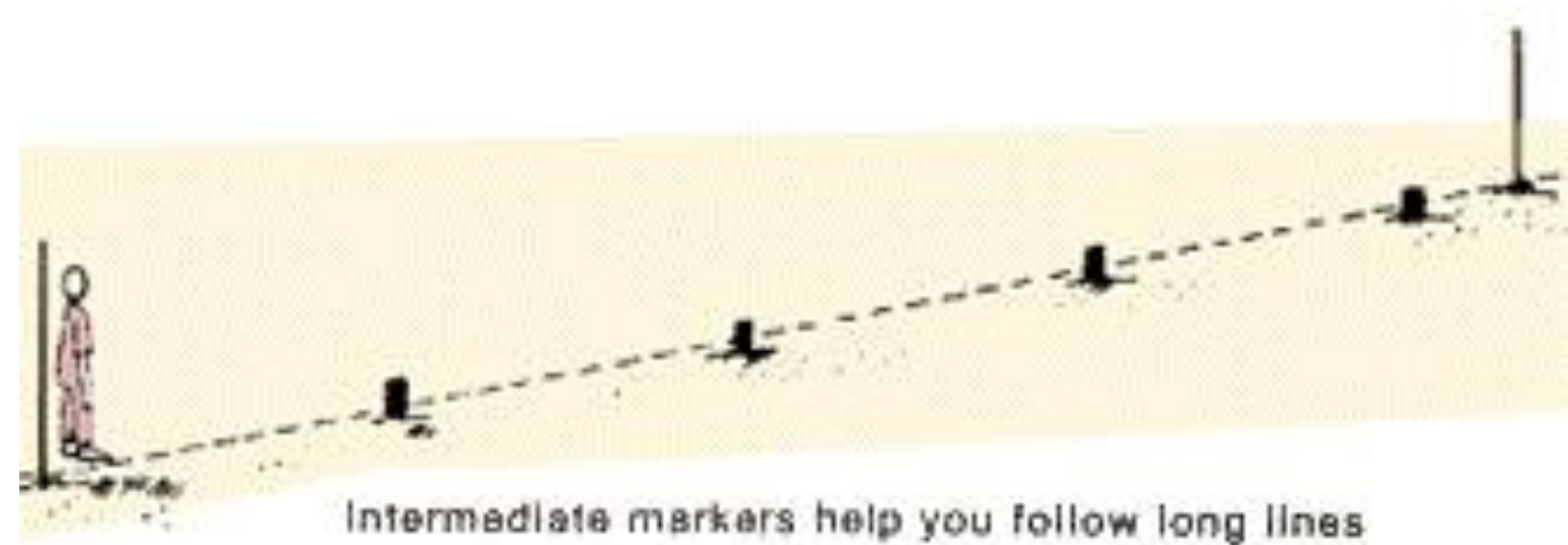

The rear chainman guides the measuring and keeps the notes, while the head chainman takes the readings



Taping is carried out by two persons, a rear man and a head man. The rear man is responsible for the measurements. He notes the results. He also guides the head man to make sure that the consecutive measurements are made exactly along straight lines between the marked ground points.

Start the measurements at one end of the straight line. Remove the ranging pole and drive the first marking pin or arrows into the ground at exactly the same point

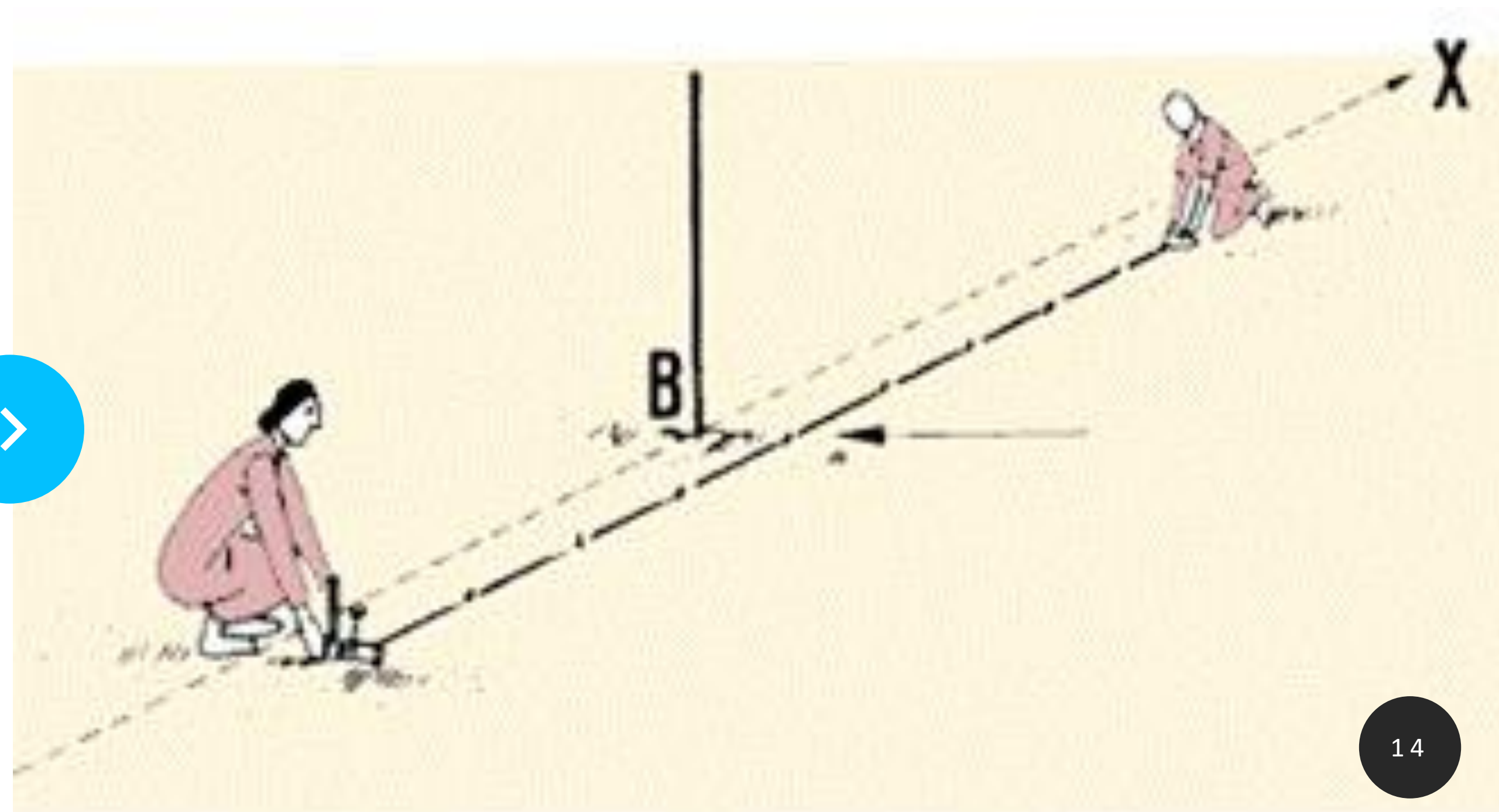

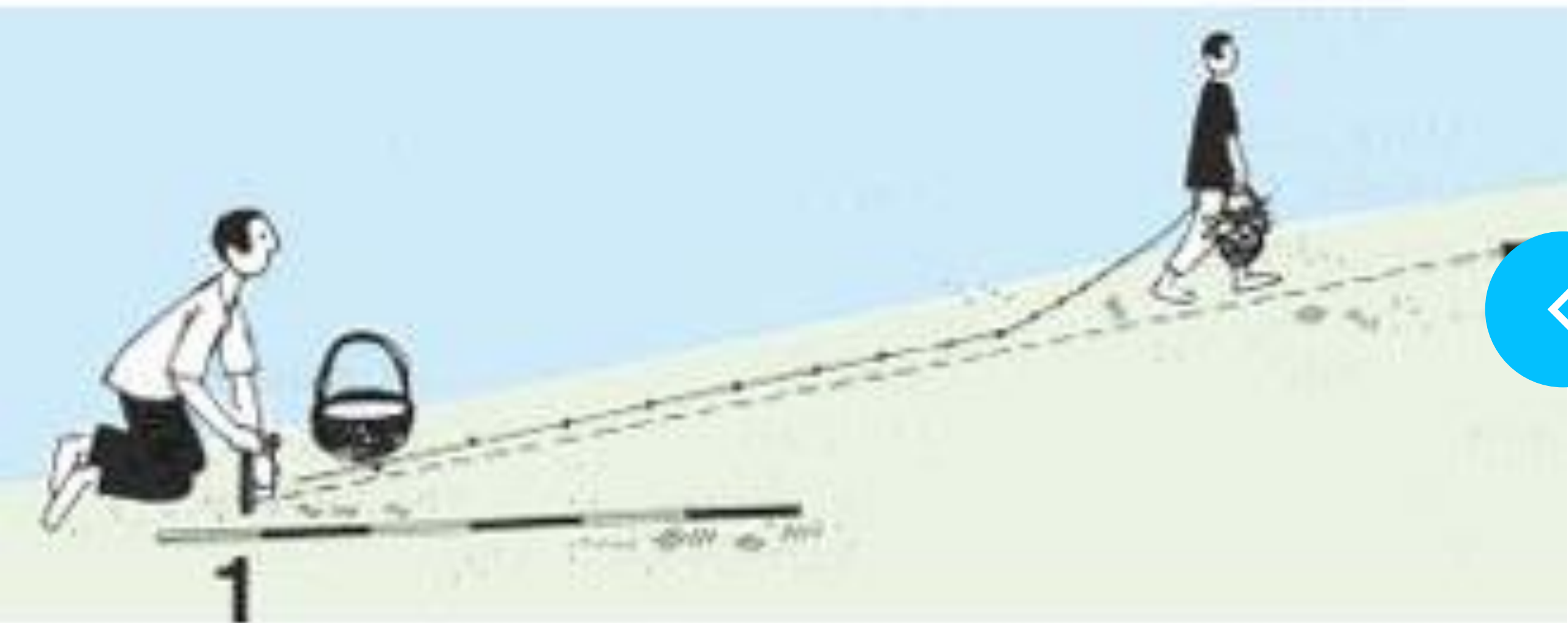

The rear man stays at the first point.. . and helps the head man find the second point

The head man stops when the measuring line is stretched out tightly to its full length on the ground. He then looks towards the rear man.

If the measuring line is not placed exactly along the straight line, the rear man then tells the head man how to correct the position of the measuring line.

When the measuring line is correctly placed, the rear man signals to the head man to place a second marking pin at the end of the measuring line.



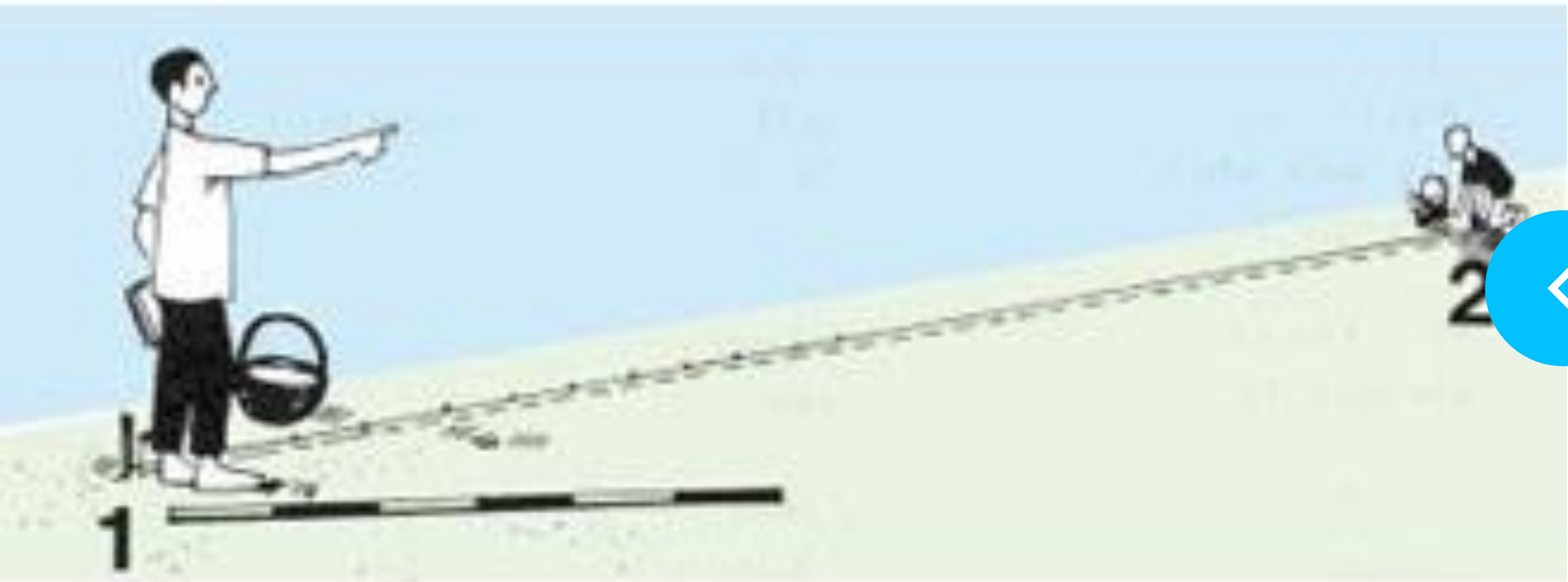

The rear man then removes the first marking pin, putting it in his basket, and replaces the ranging pole at the starting point.

The rear man then removes the first marking pin, putting it in his basket, and replaces the ranging pole at the starting point.

Still holding their ends of the measuring line, both men move forward along the straight line, always keeping the measuring line well stretched. This is particularly important when using a surveyor's chain.

The rear man stops at the second marking pin and places his end of the measuring line against it.



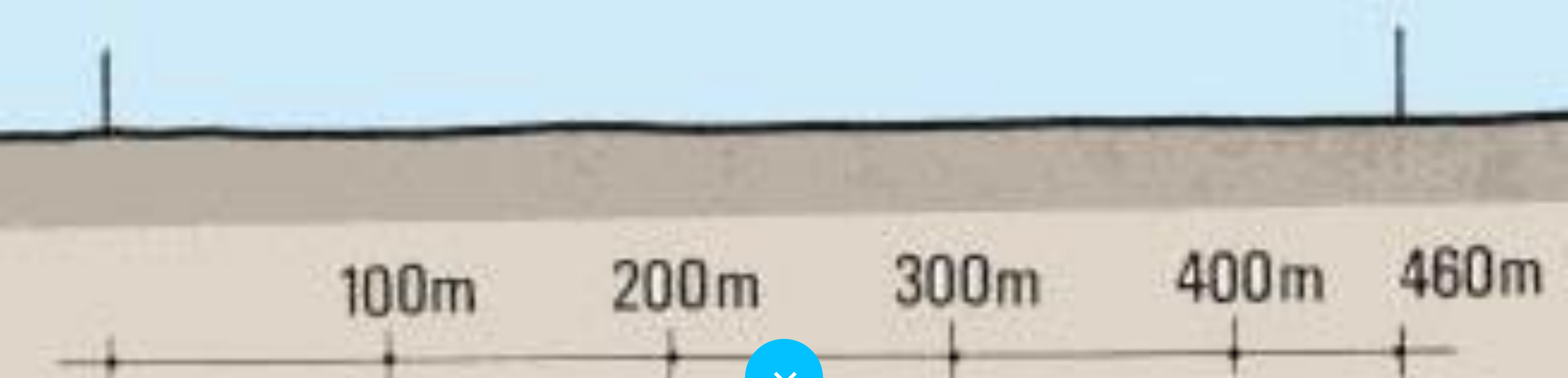

measure the distance between points 2 and 3, & number of pins (arrows)

Using a tape 100 m long, the rear man has marked 4 x 100 pins in his notebook. He has 6 marking pins in his basket. At the marking pin still in the ground, he has measured a distance of $(4 \times 100) + 60 = 460$ m

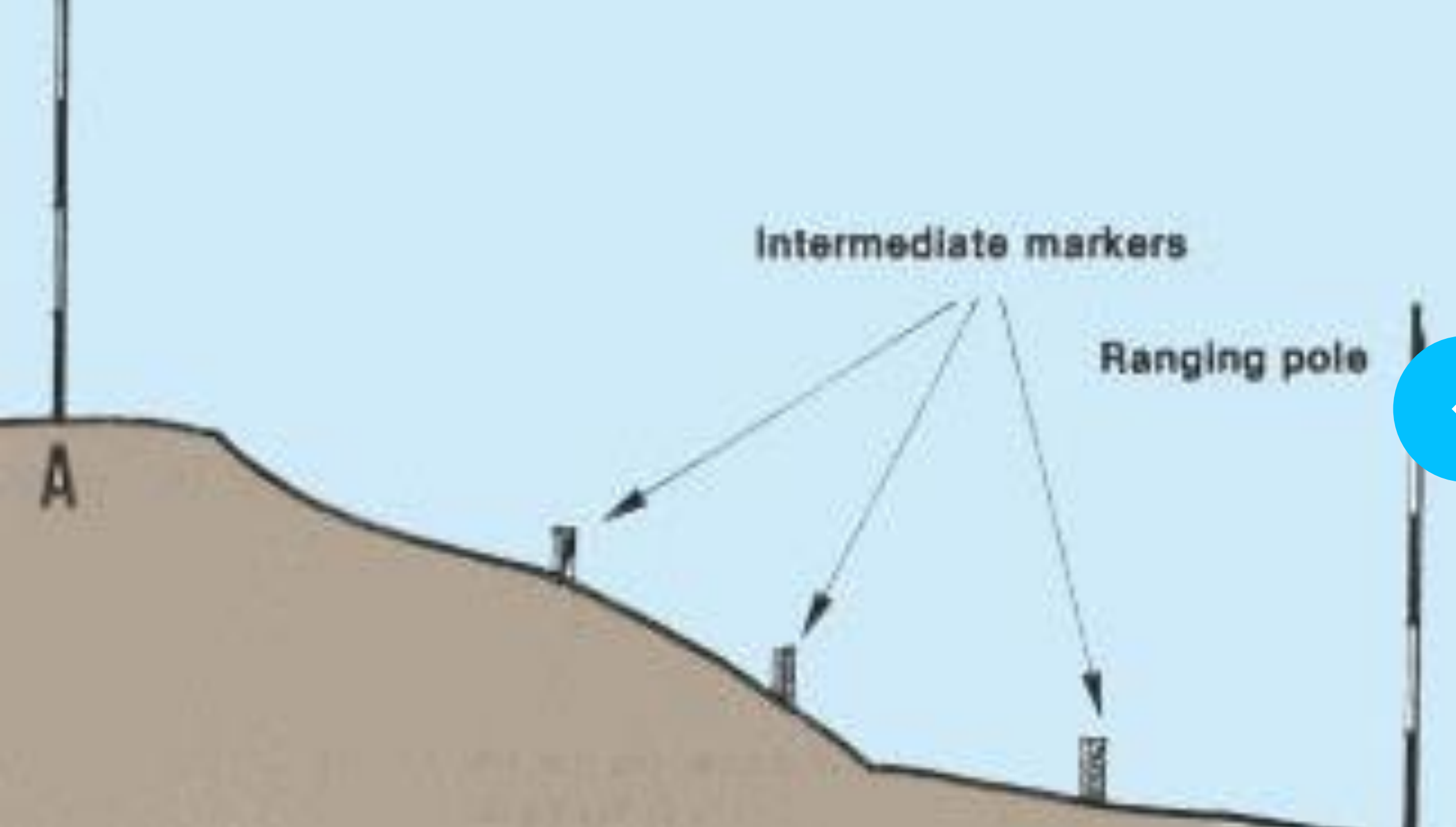

Taping over Sloping ground

When you are measuring on ground with a slope greater than 5 percent, you will need to use the measuring line differently to find the horizontal distances.

Proceed as described in the previous section. Mark the straight lines with ranging poles at each end and intermediate pegs. Remember to work downhill for greater accuracy.

The head man should hold the measuring line horizontal, above the ground, in this case.

When the measuring line is in the right place and is fully stretched, the head man finds the exact point on which to place the marking pin, using a plumb-line.

Note: on steep slopes, use a shorter measuring line (such as 5 m, rather than 10 m).

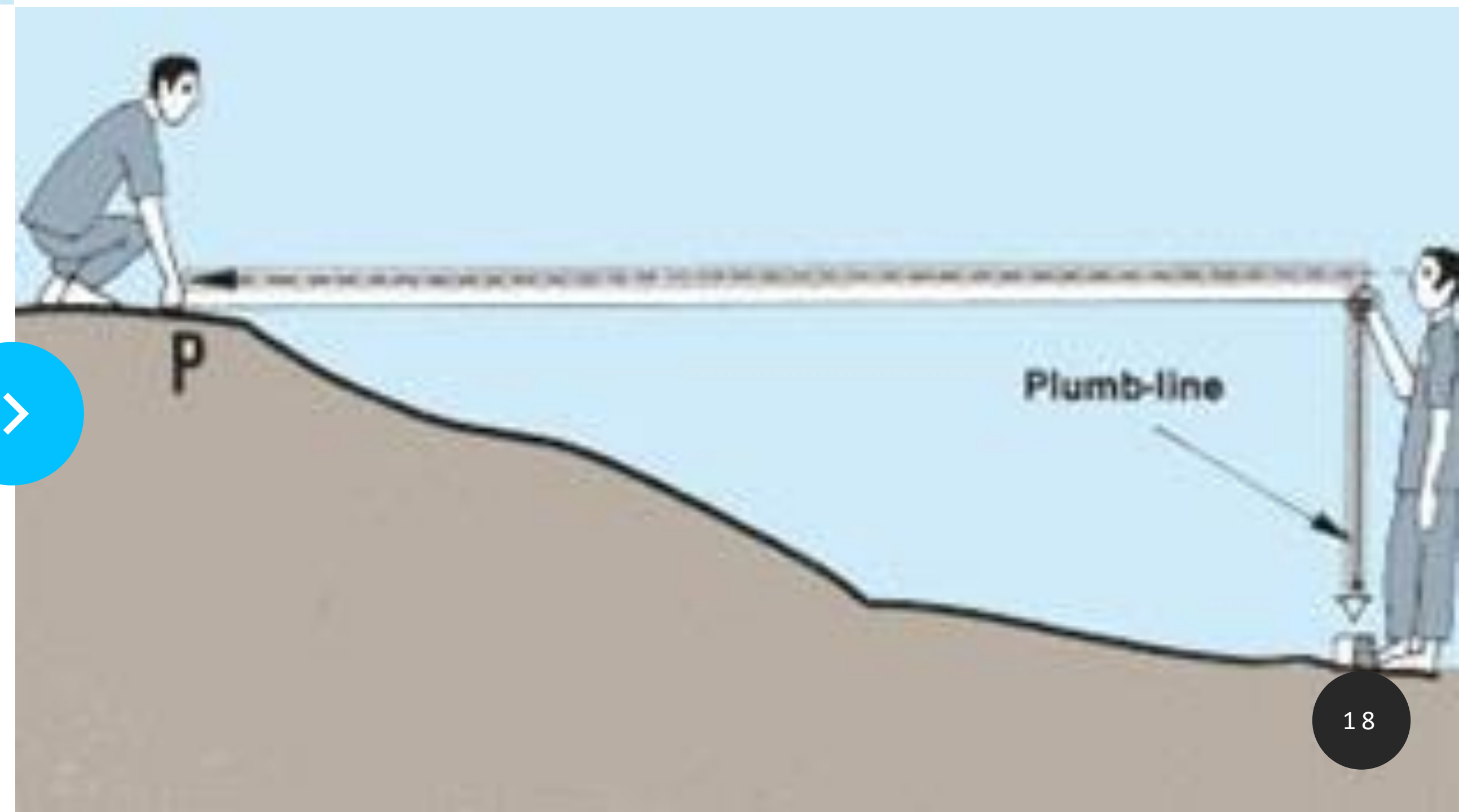

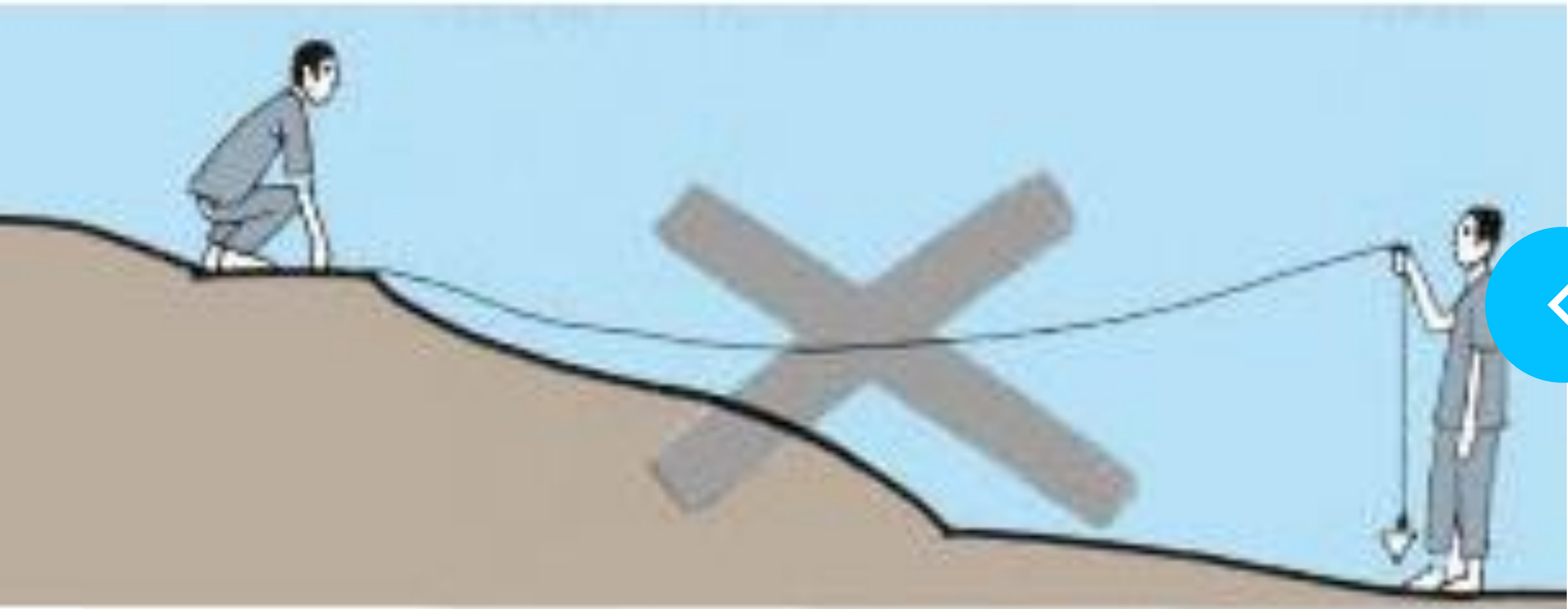

As you measure on sloping ground, remember these important requirements:

- Horizontal measurement
- Stretching tape
- Read exactly on end point

Note: you may also measure along the ground on a slope. But to obtain horizontal distances, you will need to correct these ground measurements afterwards by using mathematical formulas .

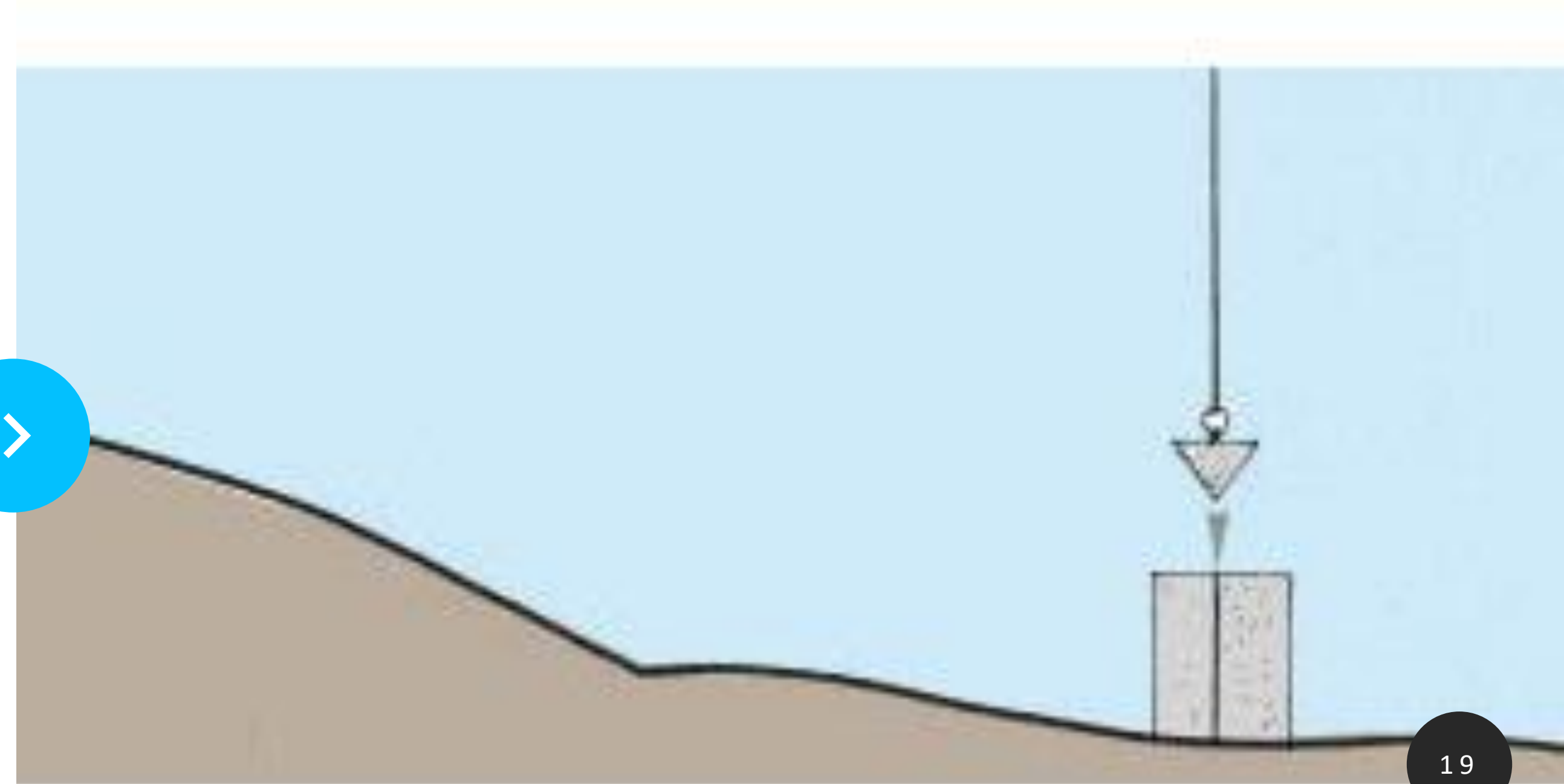

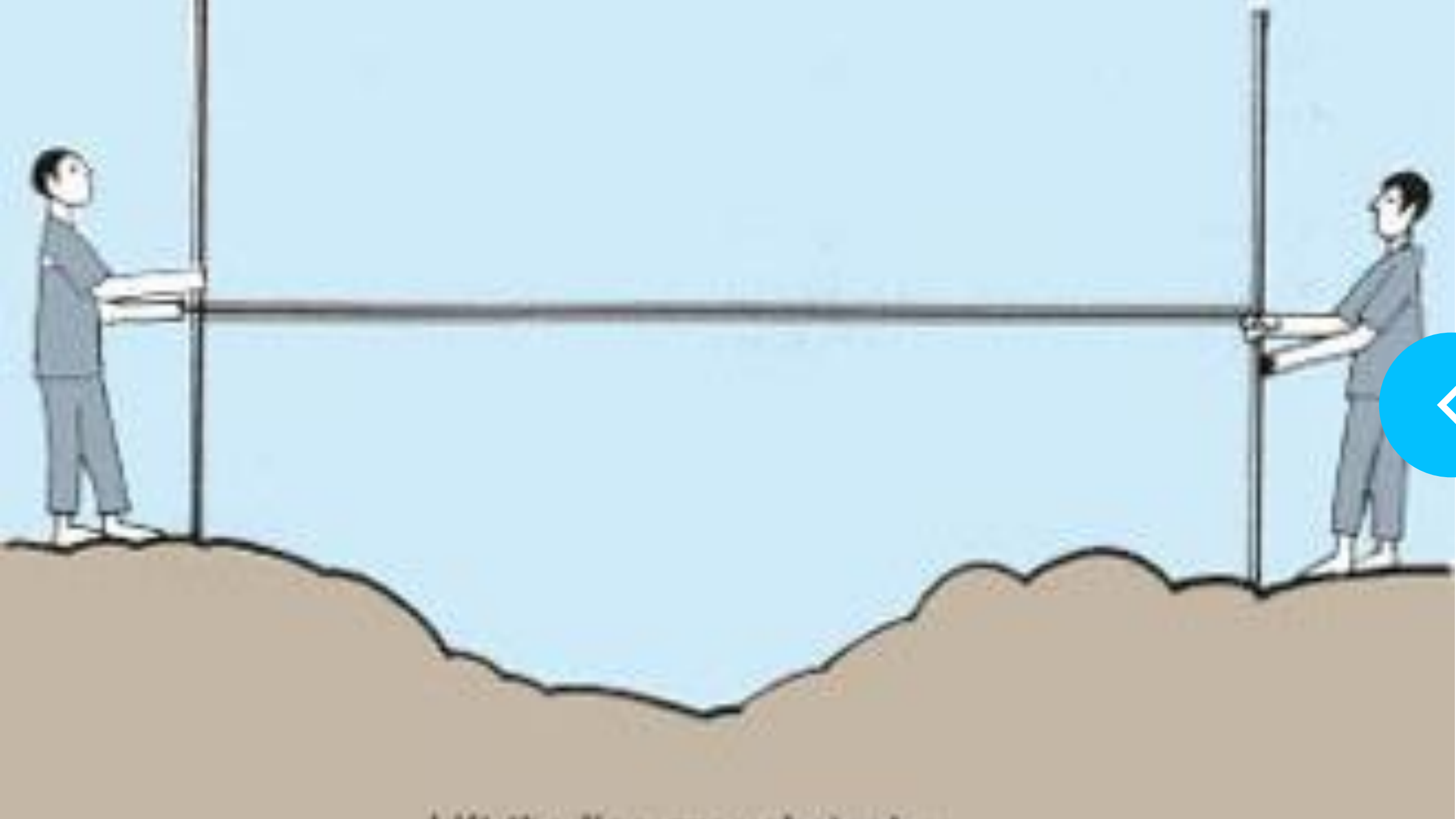

Taping over irregular ground

You may need to measure distances over irregular ground that has ridges, mounds, rocks, trenches or streams in the way. In such cases, you need to lift the measuring line above the obstacle. Make sure that you do the following:

- keep the measuring line well stretched.

- lift the back end of the measuring line exactly above the marking pin, using a plumb-line if necessary.

- keep the line horizontal, using a mason's level for the best accuracy, Instead of using a plumb-line, you can use longer marking pins, such as ranging poles, set vertically in the ground.

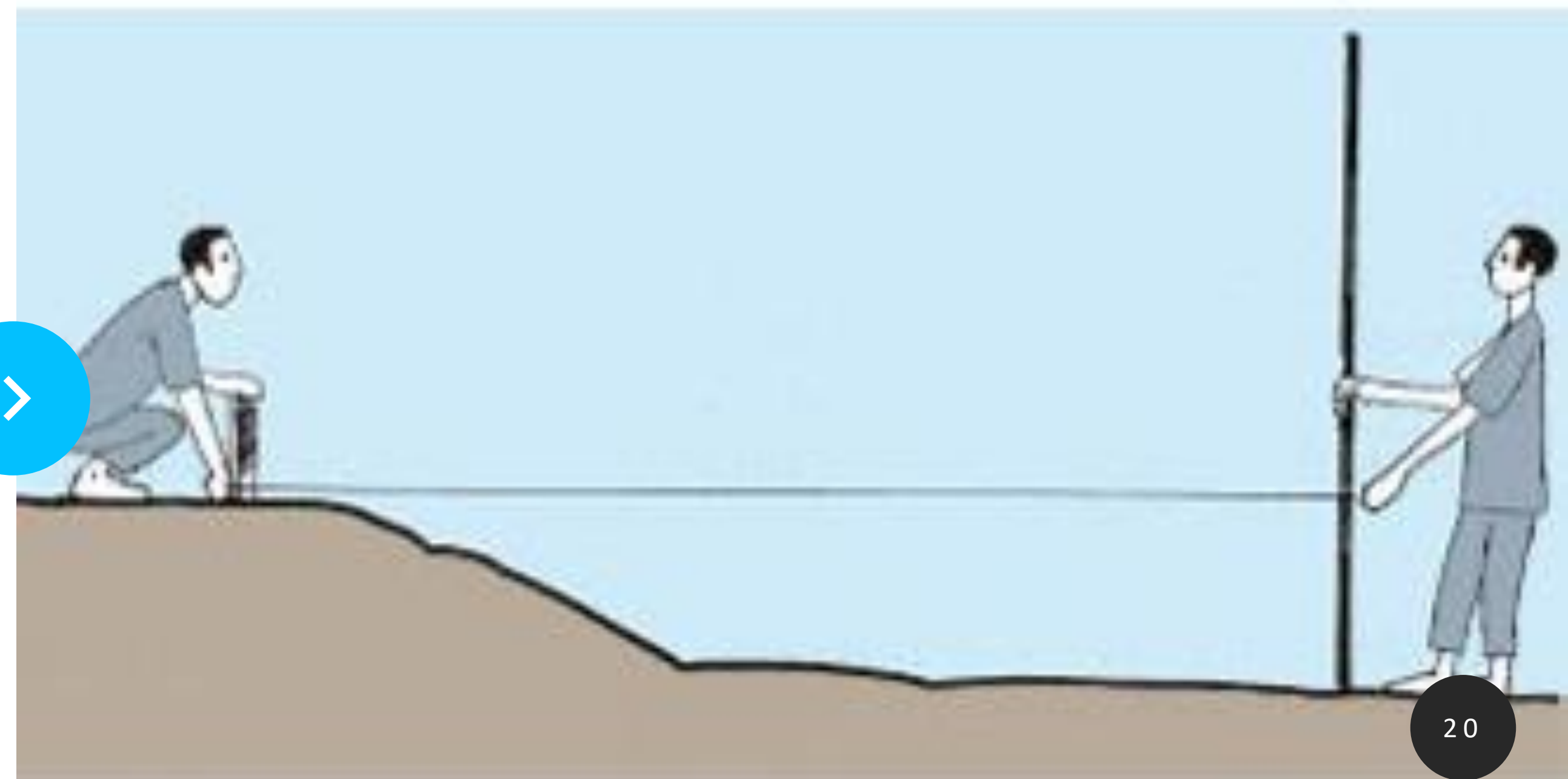

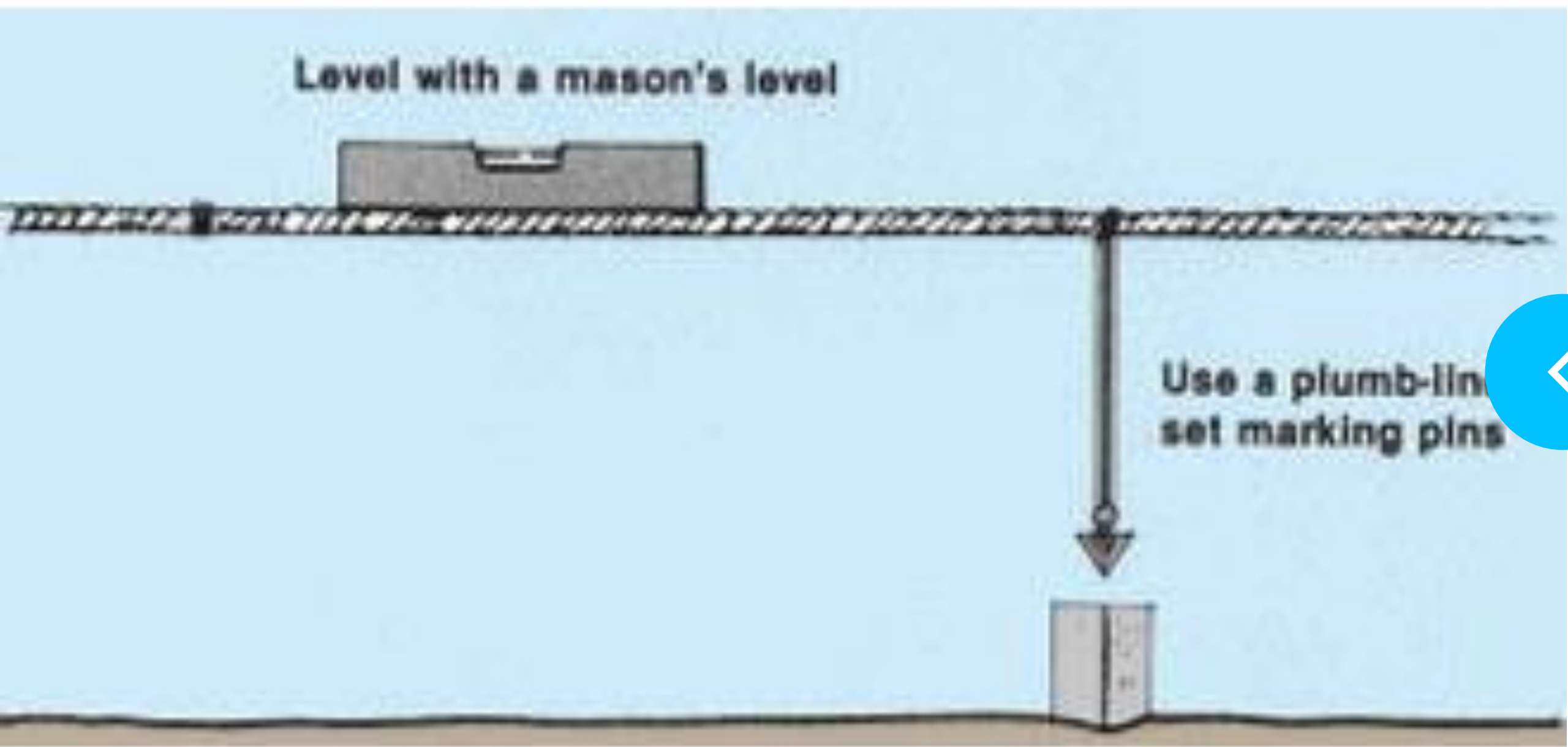

In very hard or rocky soils, you will not be able to use marking pins. In such cases, mark the points with objects you can see easily, such as painted rocks or blocks of wood.

Make sure that your markers will not blow or roll away. Or, you can make a mark on the ground with a stick or make a mark on a rock with chalk.

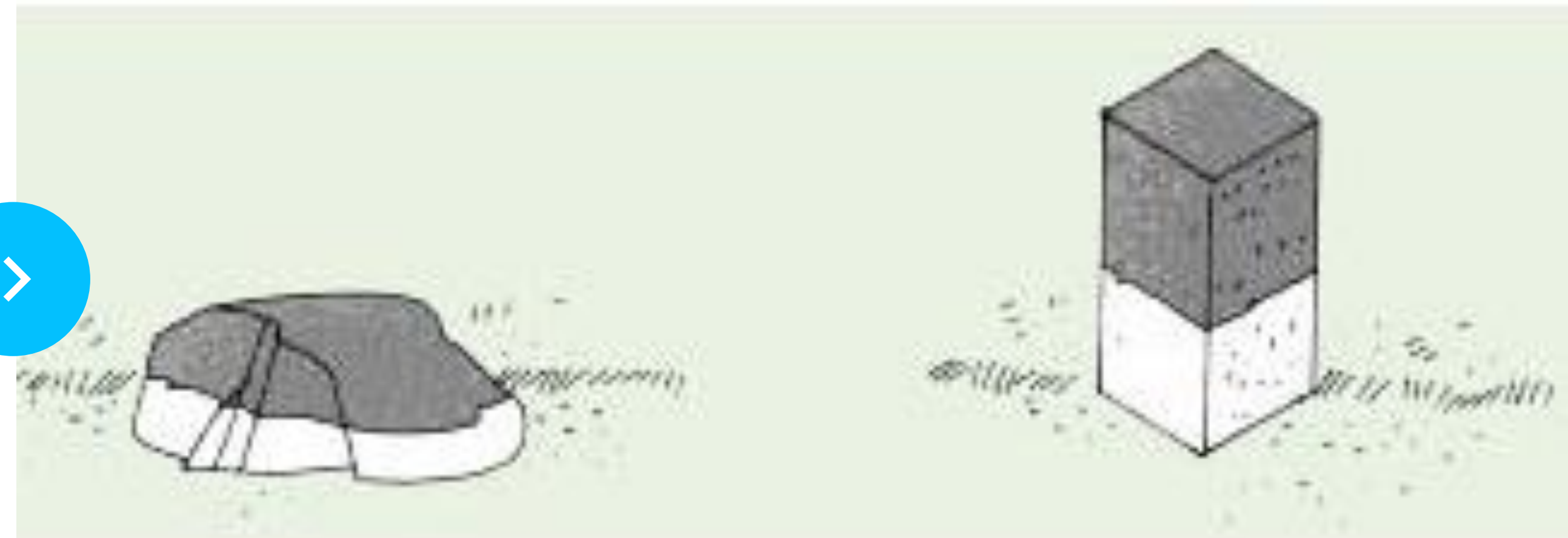

Dropping perpendicular using Tape Only

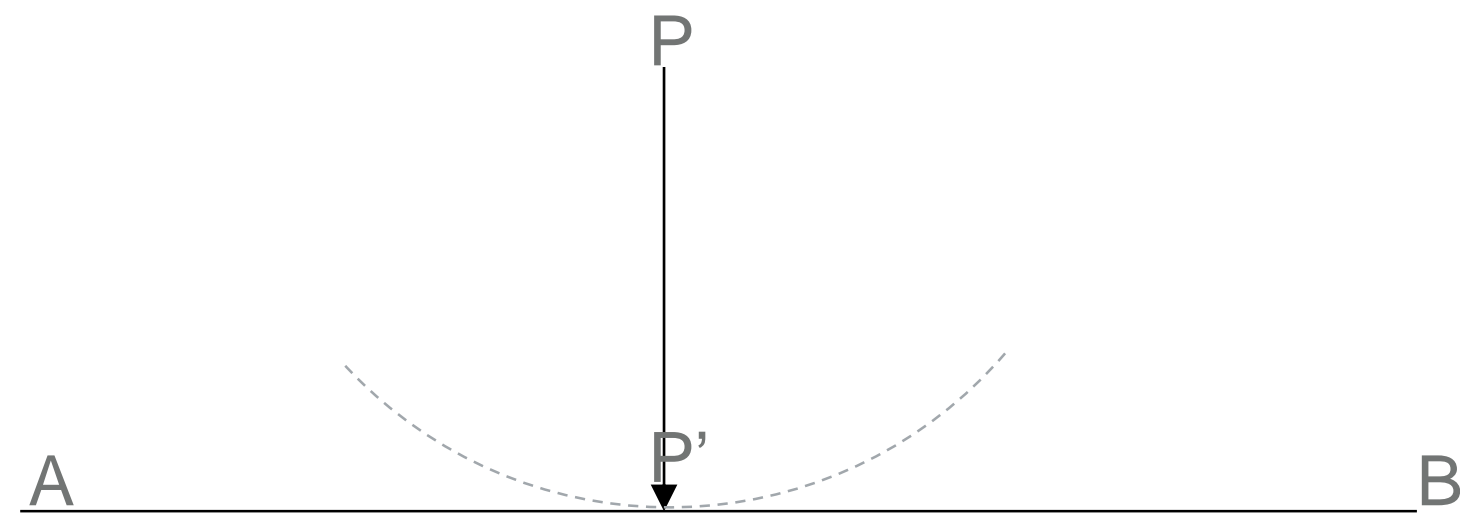

To drop a perpendicular from point P onto line AB using a tape:

a- Shortest distance from P to line AB is the perpendicular PP'.

set the tape zero at P and pull the tape to the line AB. Start moving in circular motion until you reach the smallest distance.

b- Constructing two congruent triangles with P as common point.

Set out $PC=PD$. Bisect CD at P'. PP' will be the perpendicular from P on AB.

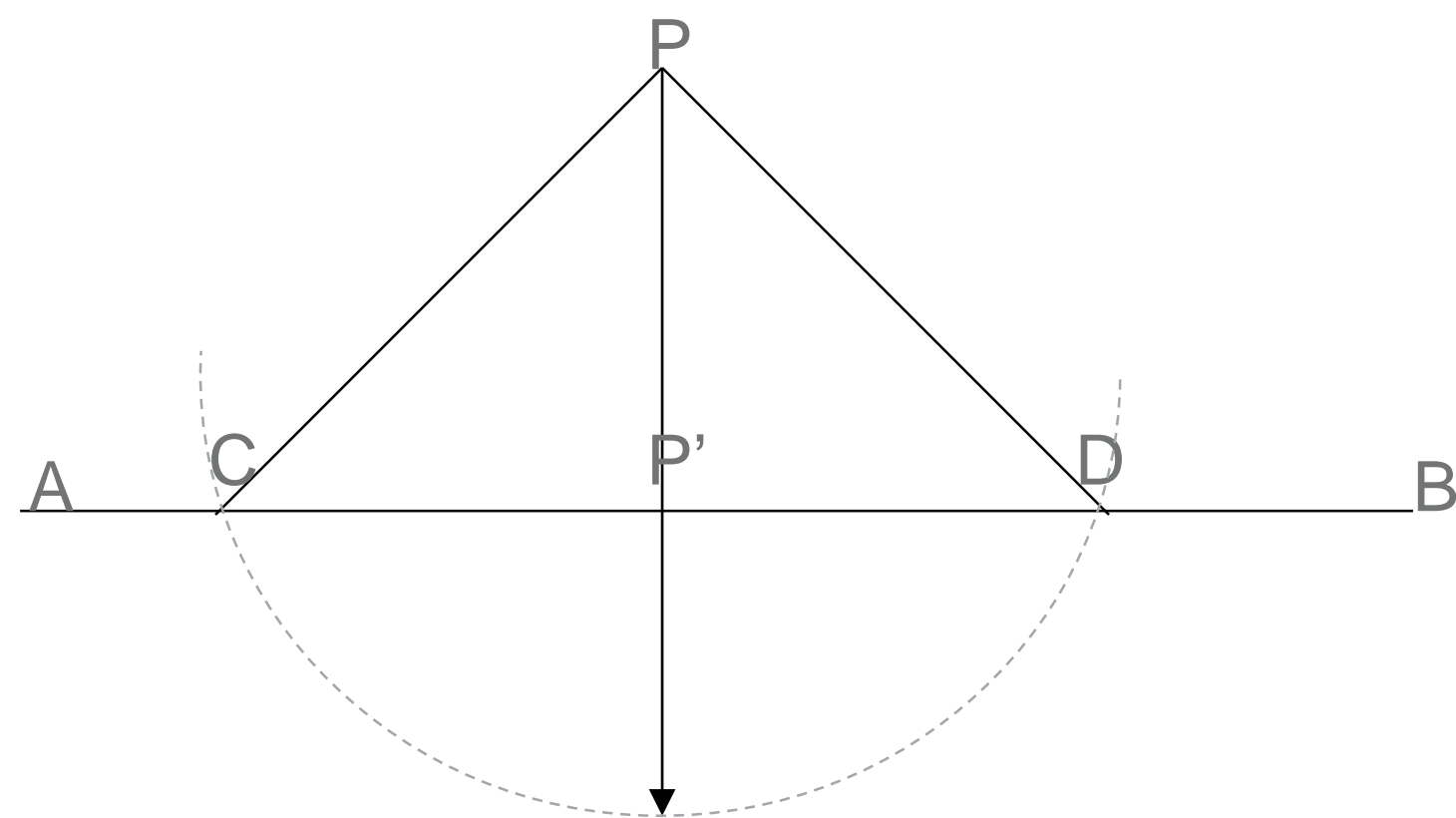

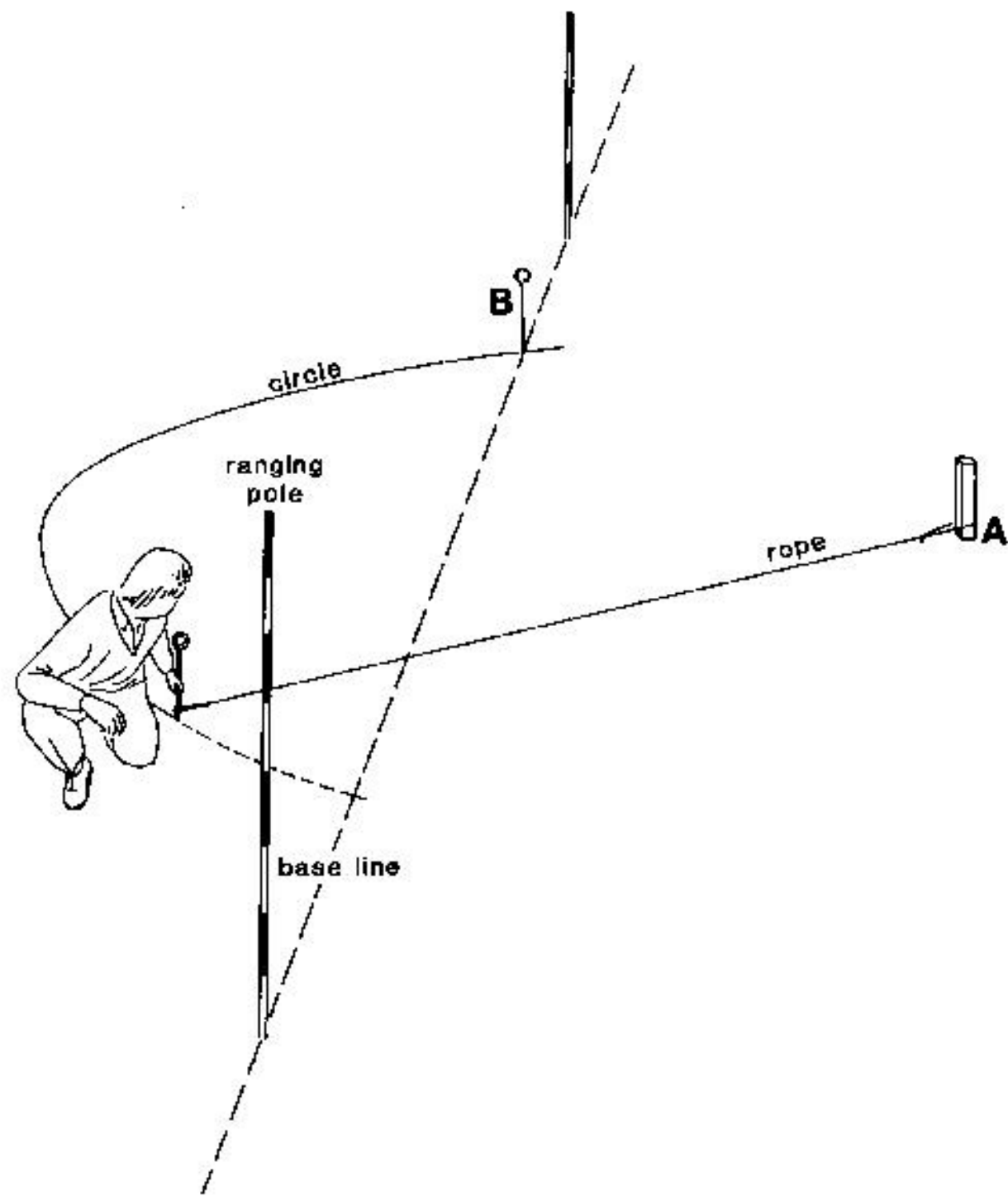

A line has to be set out perpendicular to the base line from peg (A).
Peg (A) is not on the base line.

A long rope with a loop at both ends and a measuring tape are used. The rope should be a few metres longer than the distance from peg (A) to the base line.

One loop of the rope is placed around peg (A). Put a peg through the other loop of the rope and make a circle on the ground while keeping the rope straight. This circle crosses the base line twice. Pegs (B) and (C) are placed where the circle crosses the base line.

Peg (D) is placed exactly half way in between pegs (B) and (C). Use a measuring tape to determine the position of peg (D). Pegs (D) and (A) form the line perpendicular to the base line and the angle between the line CD and the base line is a right angle

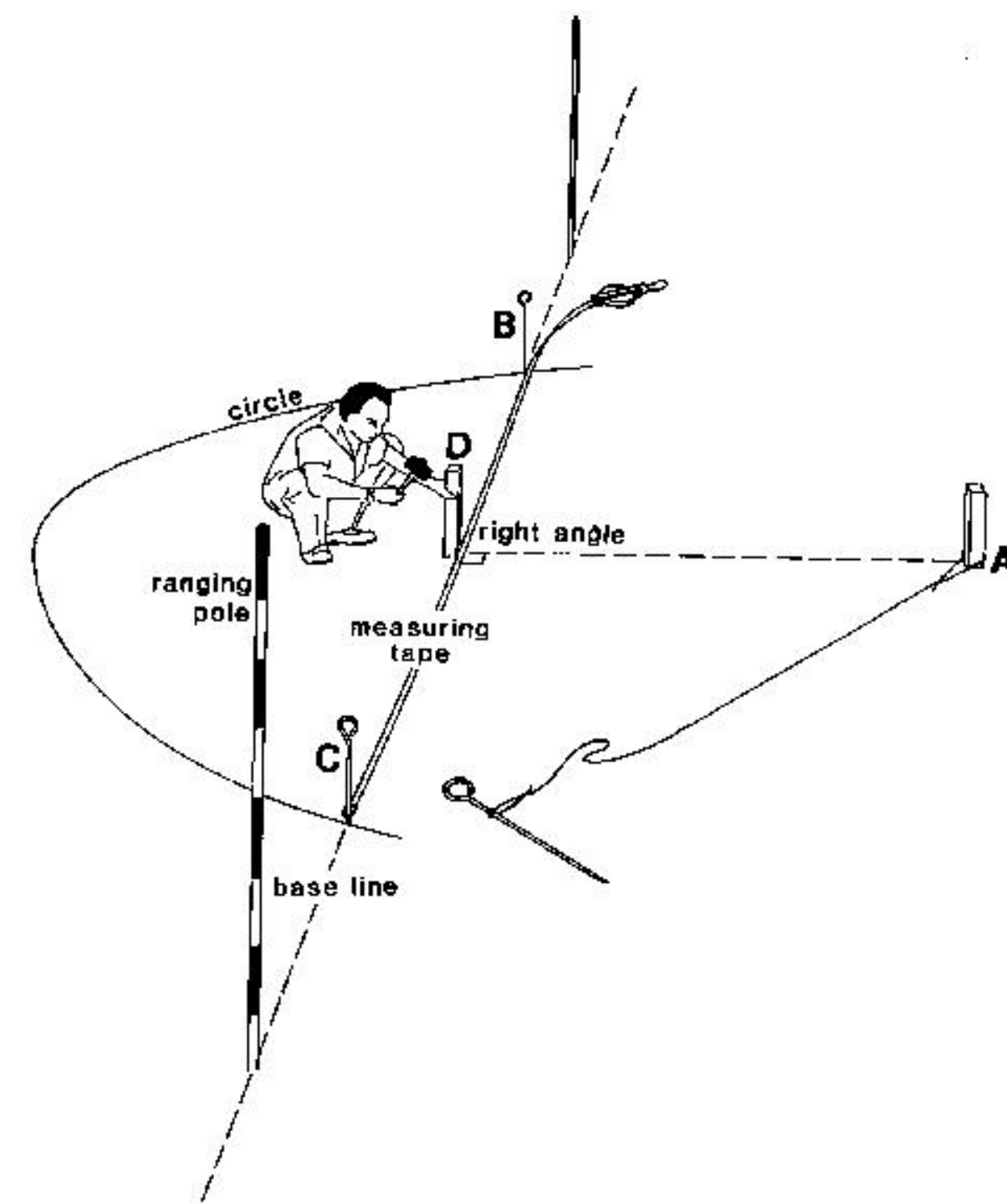
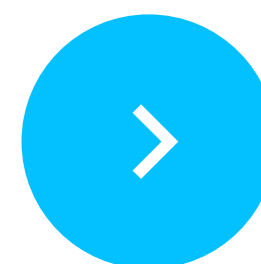

Erecting perpendicular using Tape Only

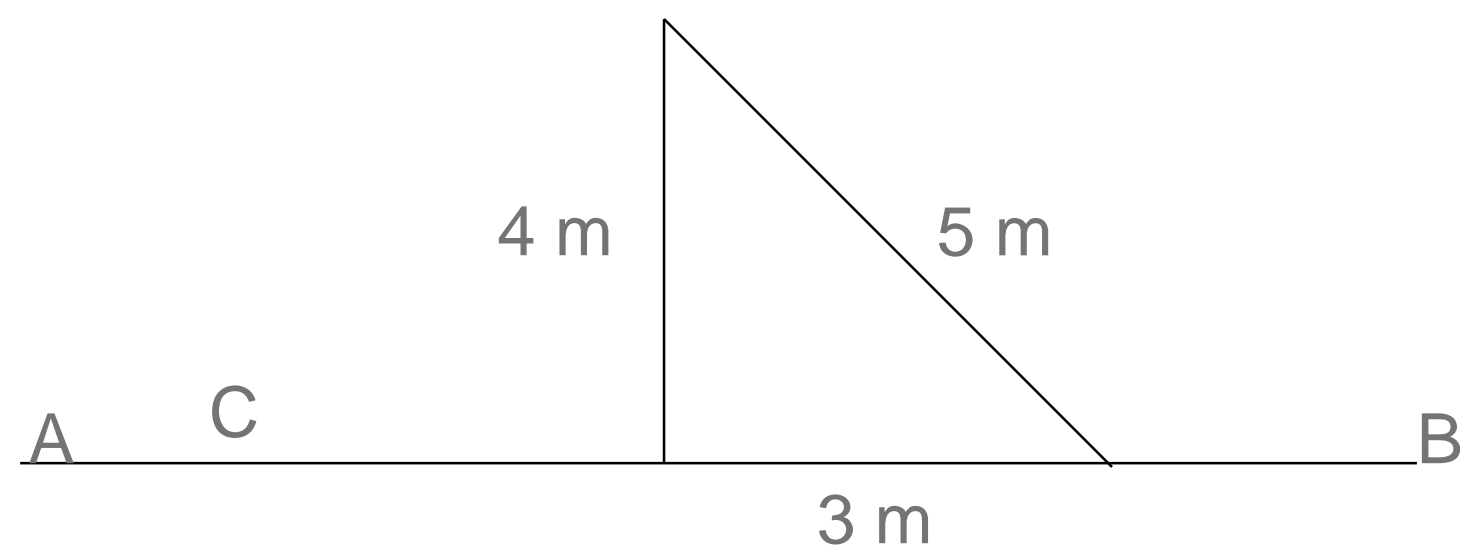
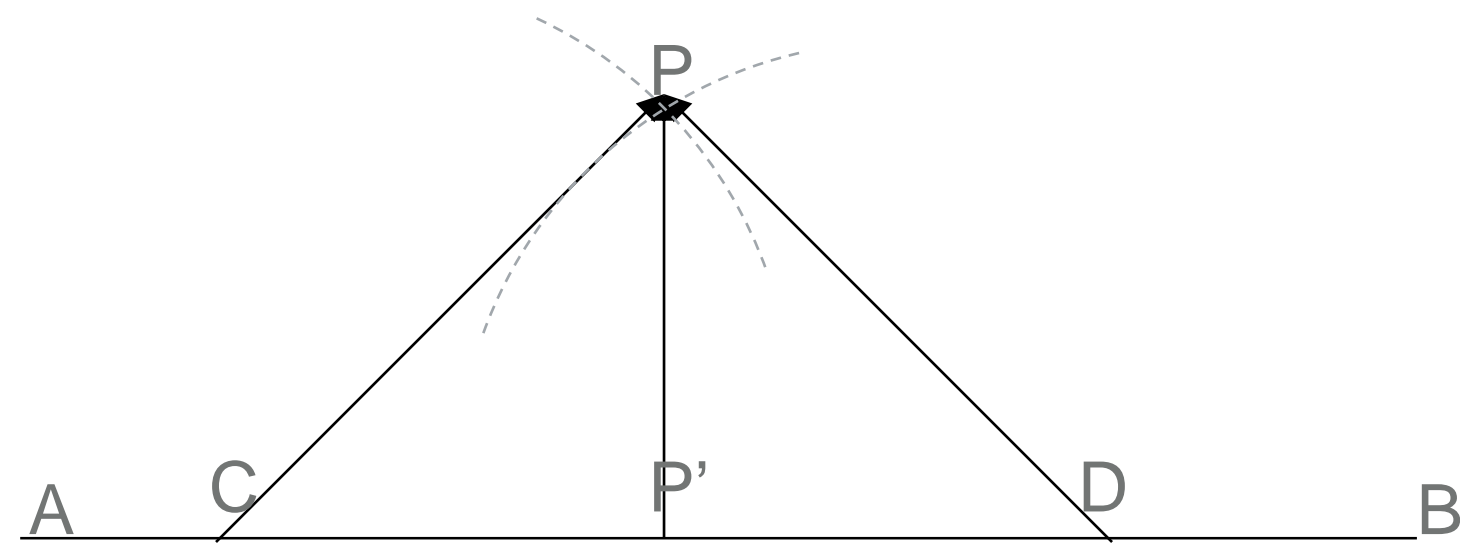

To erect a perpendicular from line AB at point P:

a-Reverse of method in b above: mark any two points C and D on AB, equidistant

From point P. Intersection of two equal arcs from C and D will be P', PP' is the required perpendicular from P.

b-Constructing right angled triangle: sides: 3,4,5 or 6,8 10

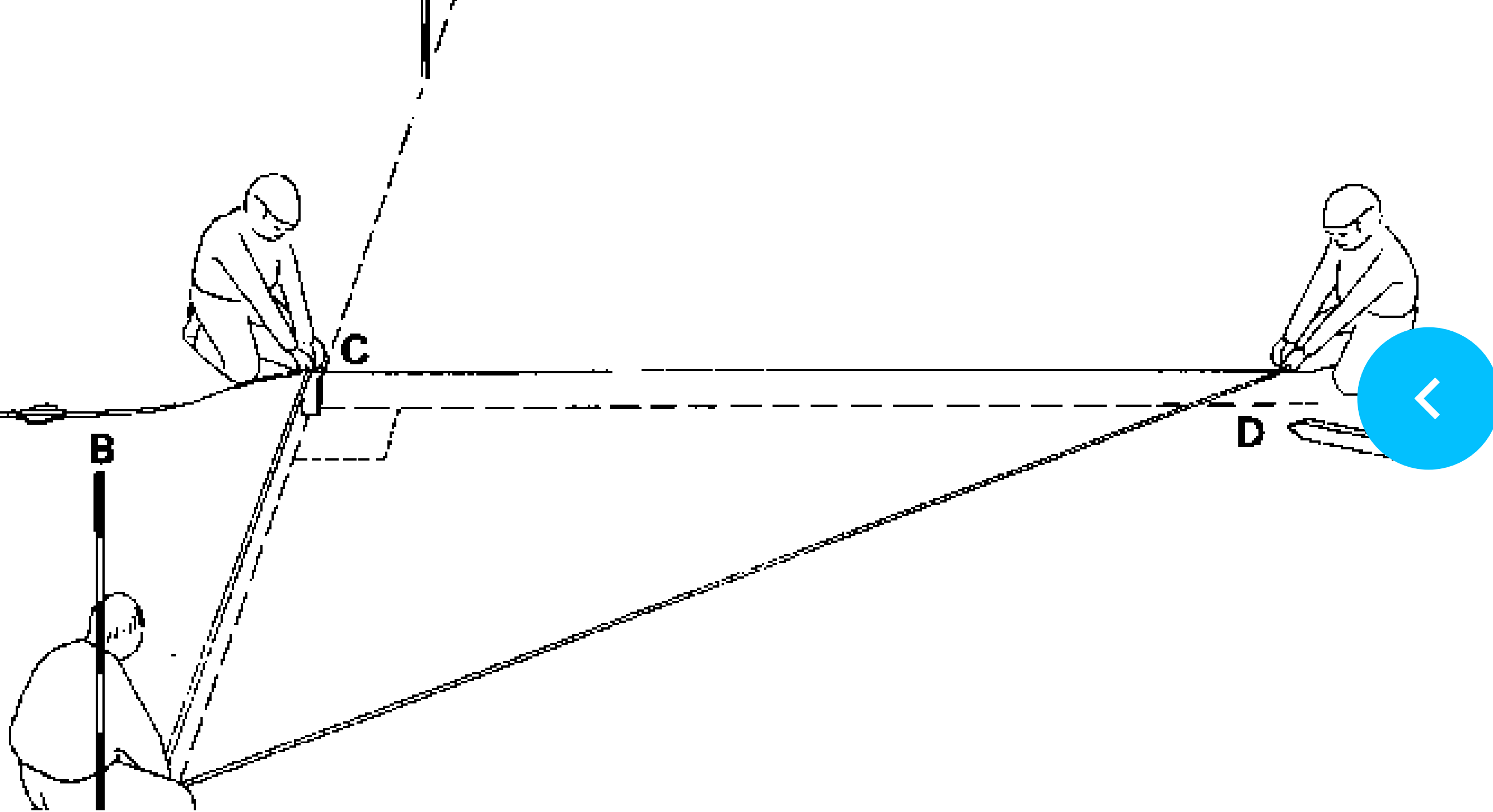

To set out right angles in the field, a measuring tape, two ranging poles, pegs and three persons are required.

The first person holds together, between thumb and finger, the zero mark and the 12 metre mark of the tape. The second person holds between thumb and finger the 3 metre mark of the tape and the third person holds the 8 metre mark.

When all sides of the tape are stretched, a triangle with lengths of 3 m, 4 m and 5 m is formed (see Fig. 20), and the angle near person 1 is a right angle.

Instead of 3 m, 4 m and 5 m a multiple can be chosen: e.g. 6 m, 8 m and 10 m or e.g. 9 m, 12 m and 15 m.

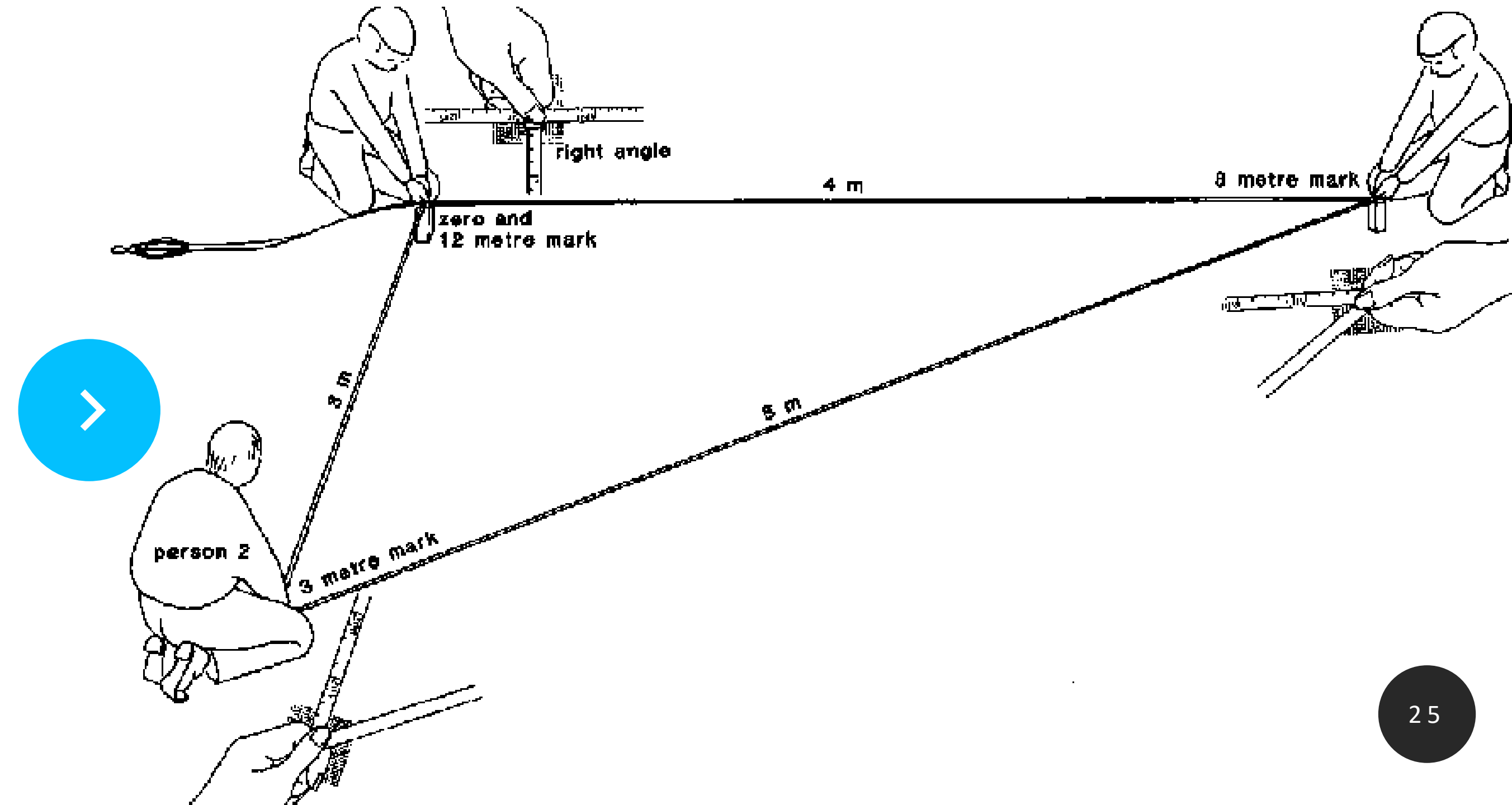

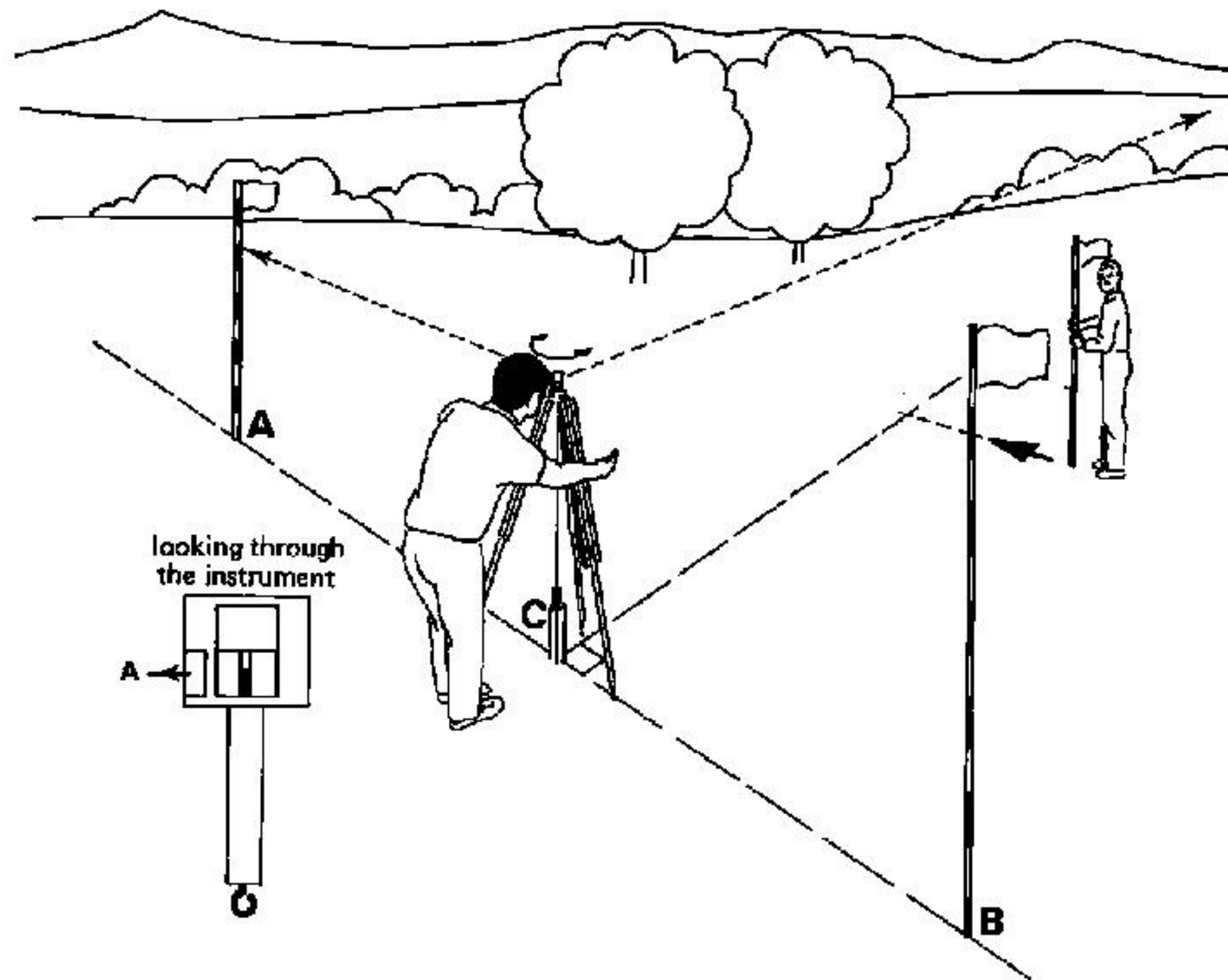

An assistant should hold pole (D) in such a way that it can be seen when looking through the opening just above the prism.

At the indication of the operator, pole (D) is slightly moved so that pole (D) forms one line (when looking through the instrument) with the image of pole (A). The line connecting pole (D) and peg (C) forms a right angle with the base line.



Erecting perpendicular Using Prism square

peg (C) is on the base line which is defined by poles (A) and (B). A right angle has to be set out, starting from peg (C).

The prismatic square has to be placed vertically above peg (C).

The instrument is slowly rotated until the image of pole A can be seen when looking through the instrument

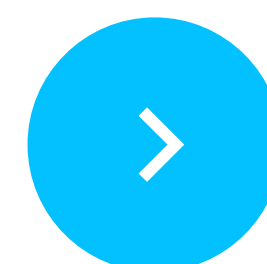
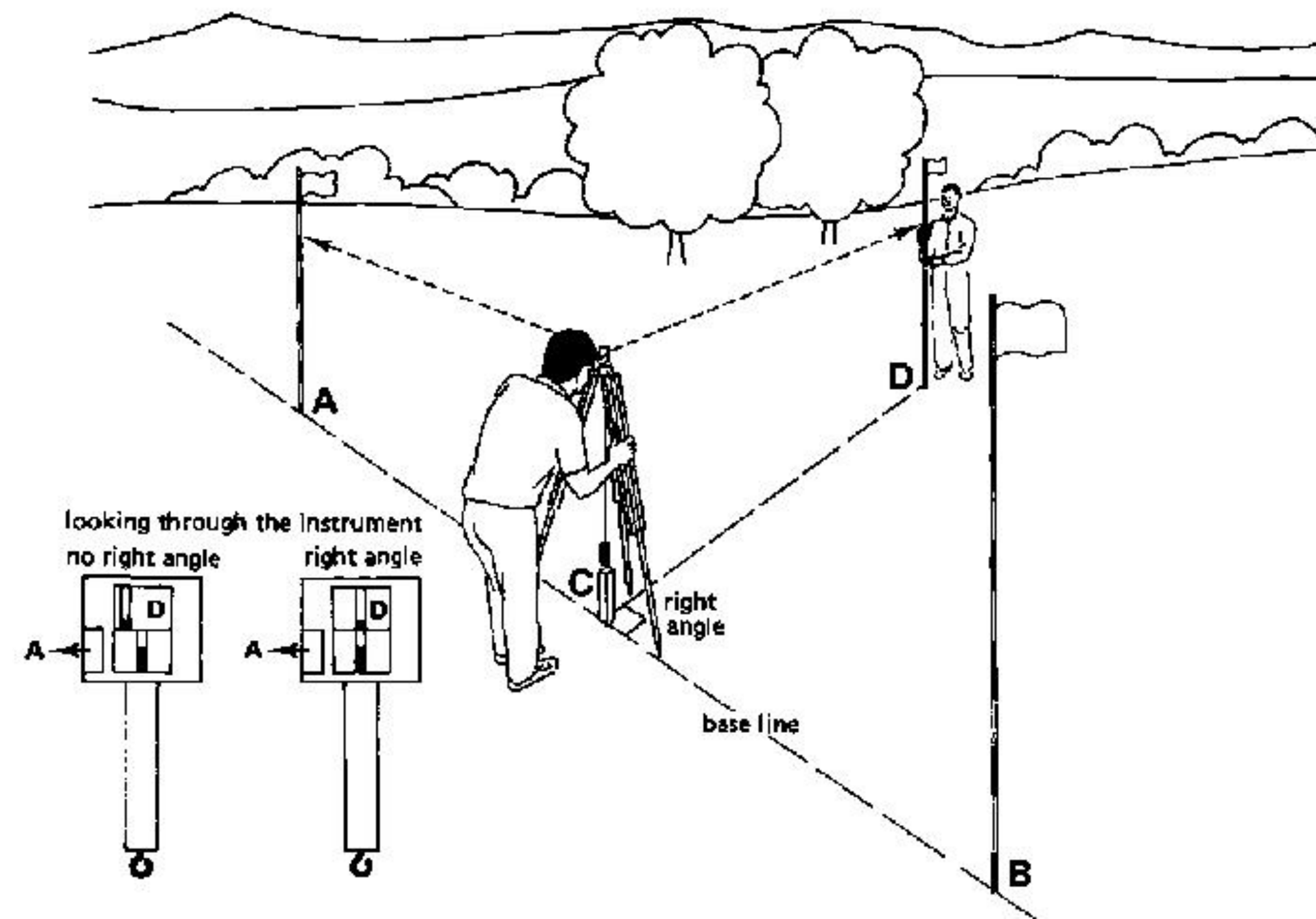

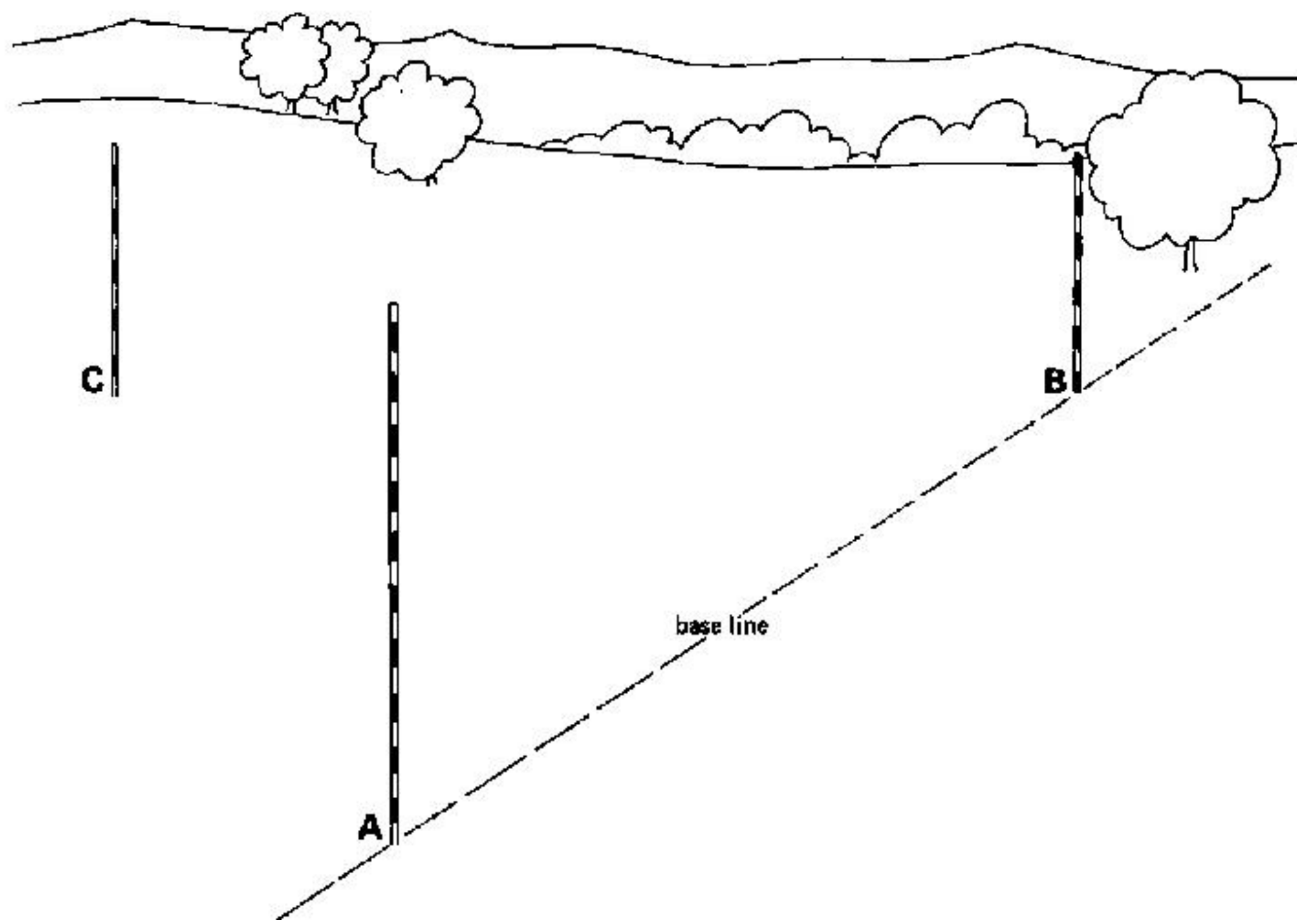

The operator should stand with the instrument on the base line (connecting A and B). To check this, the assistant, standing behind pole (A) (or B), makes sure that the plumb bob, attached to the instrument, is in line with poles (A) and (B). The operator then rotates the instrument until the image of pole (A) can be seen.

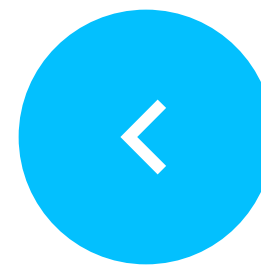

Dropping perpendicular Using Prism square

the base line is defined by poles (A) and (B). A line perpendicular to the base line has to be set out from pole (C); pole (C) is not on the base line.

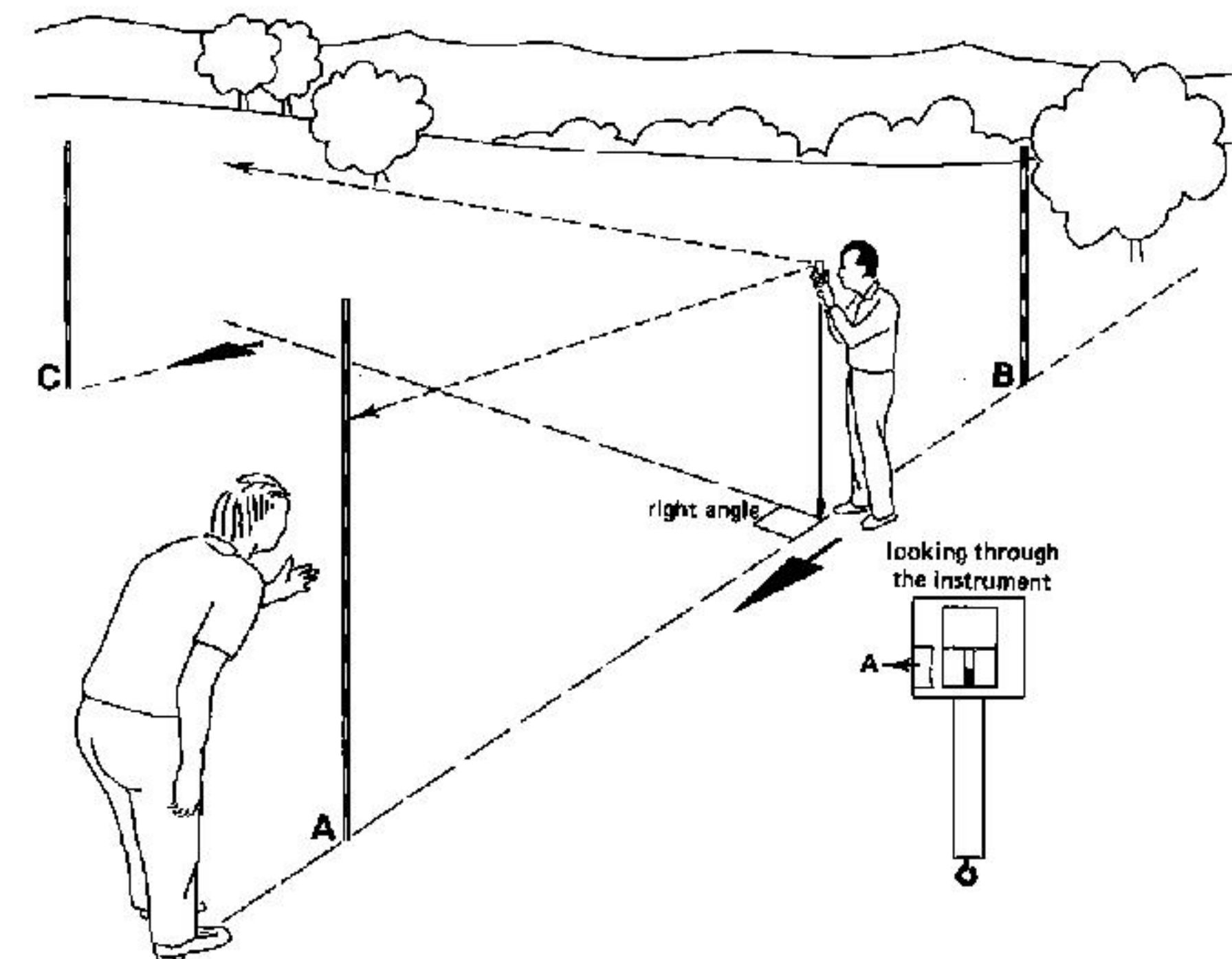
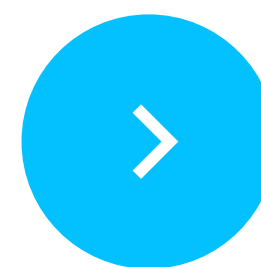

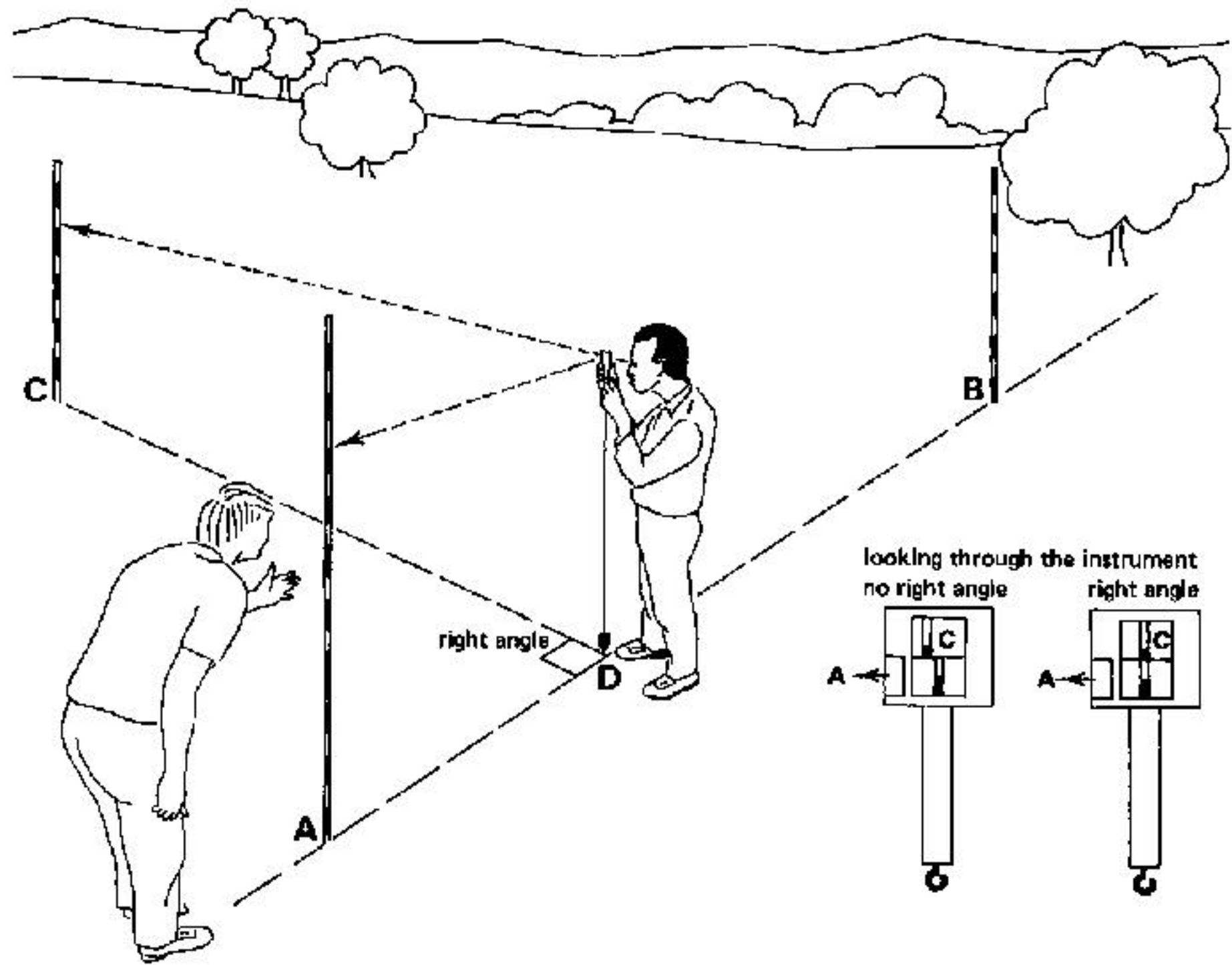

When the correct position of the instrument is found, peg (D) is placed right under the plumb bob. The line connecting pole (C) and peg (D) is a line perpendicular to the base line

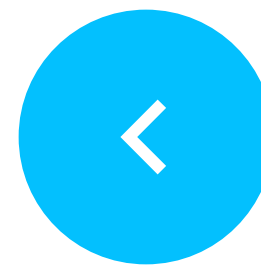

The operator then moves the instrument along the base line until he finds a position for which (when looking through the instrument) pole (C) is in line with the image of pole (A). While searching for the right position, the operator must keep the instrument always in line with poles (A) and (B). This is done under the guidance of the assistant standing behind pole (A).

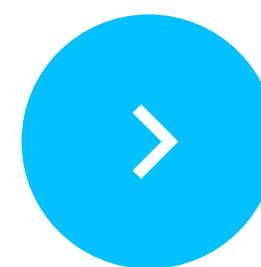
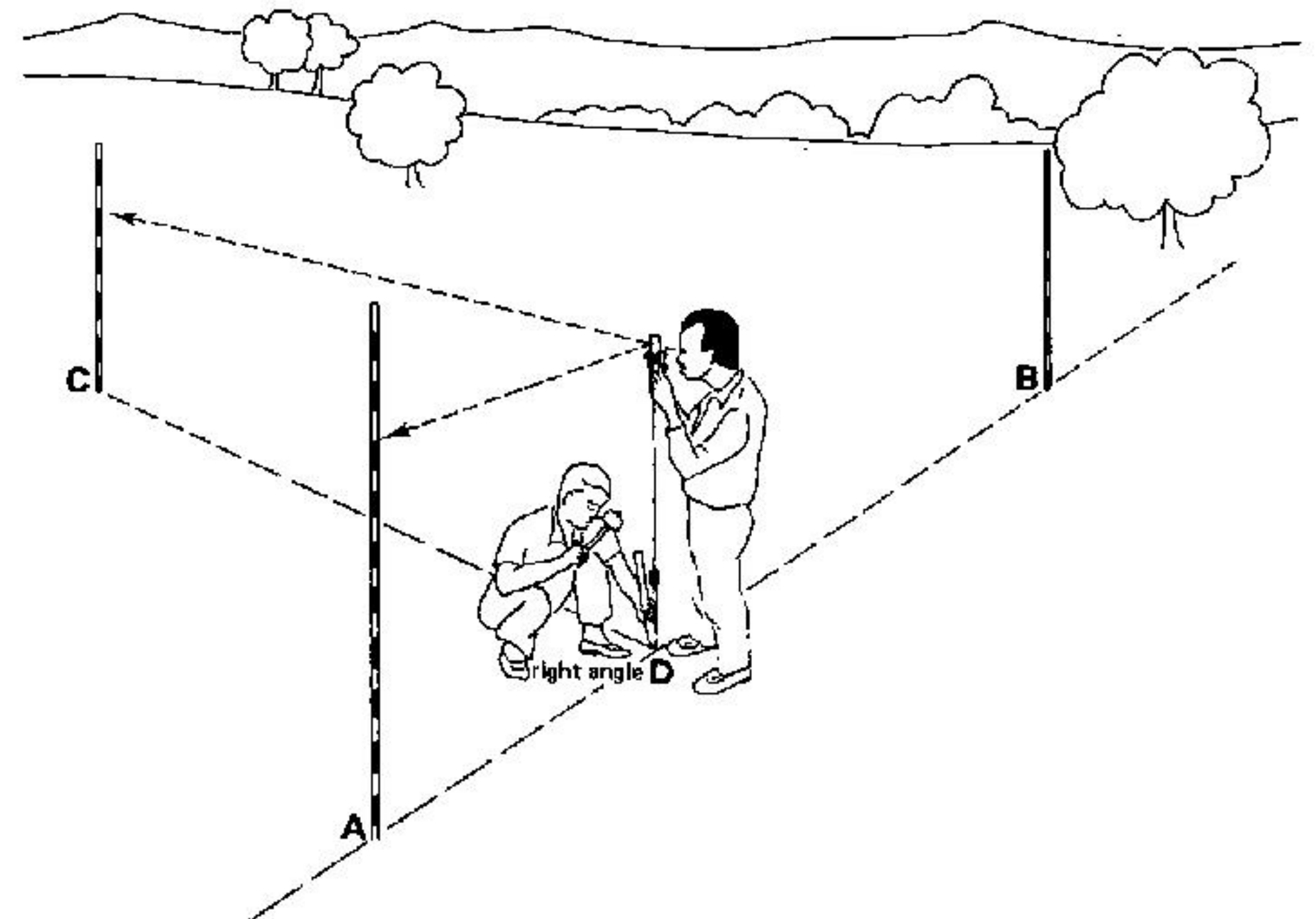

Measuring Distances Along Lines that Run Through Obstacles

To use the preceding methods, you must be able to walkover the whole length of each straight line and take direct measurements. Sometimes, however, there is an obstacle on the line that makes measuring the distance directly impossible. Such a line could be across a body of water such as a lake, a lagoon or a river, or across agricultural fields with standing crops. In these cases, you must take indirect measurements of a segment of the line.

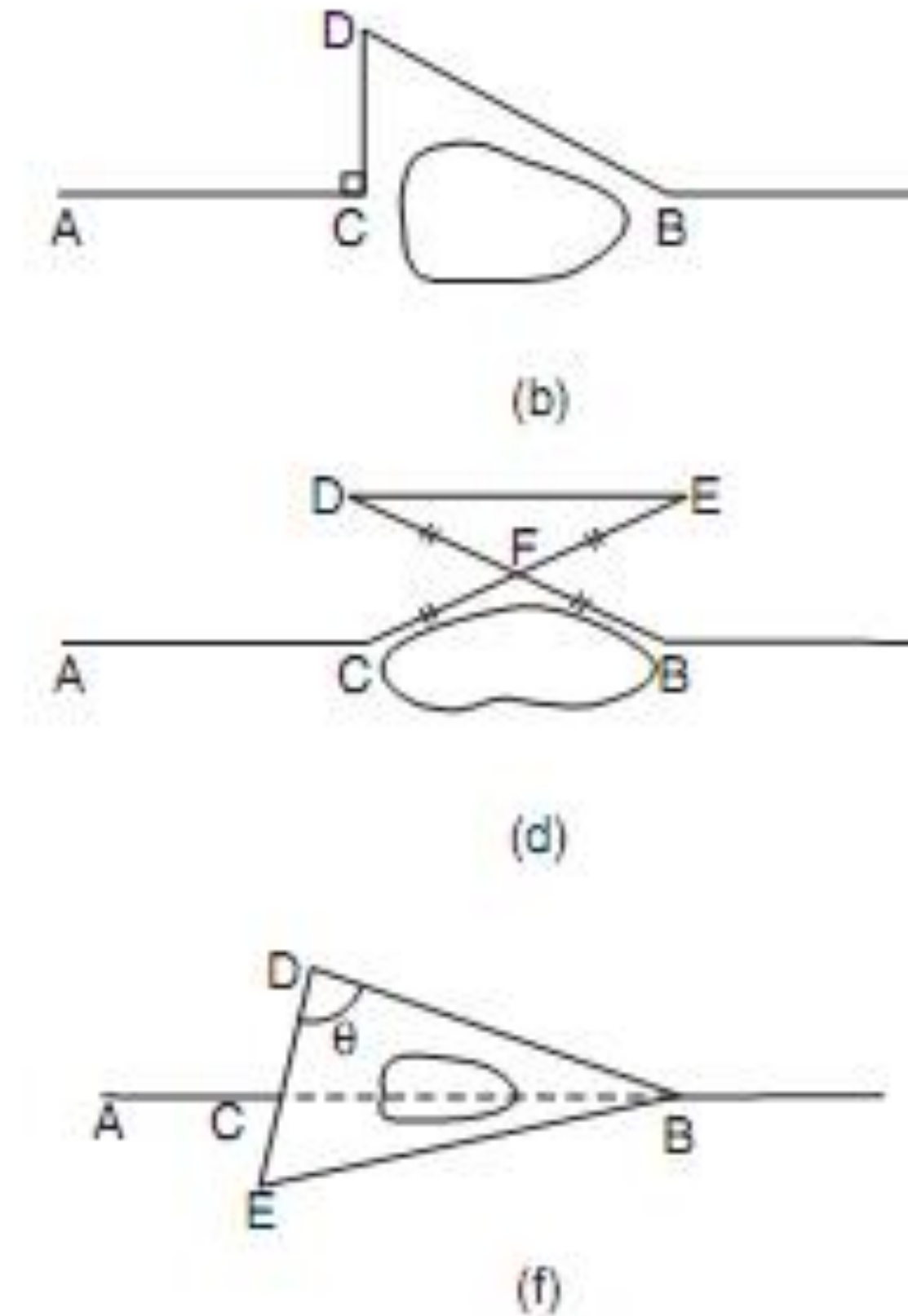
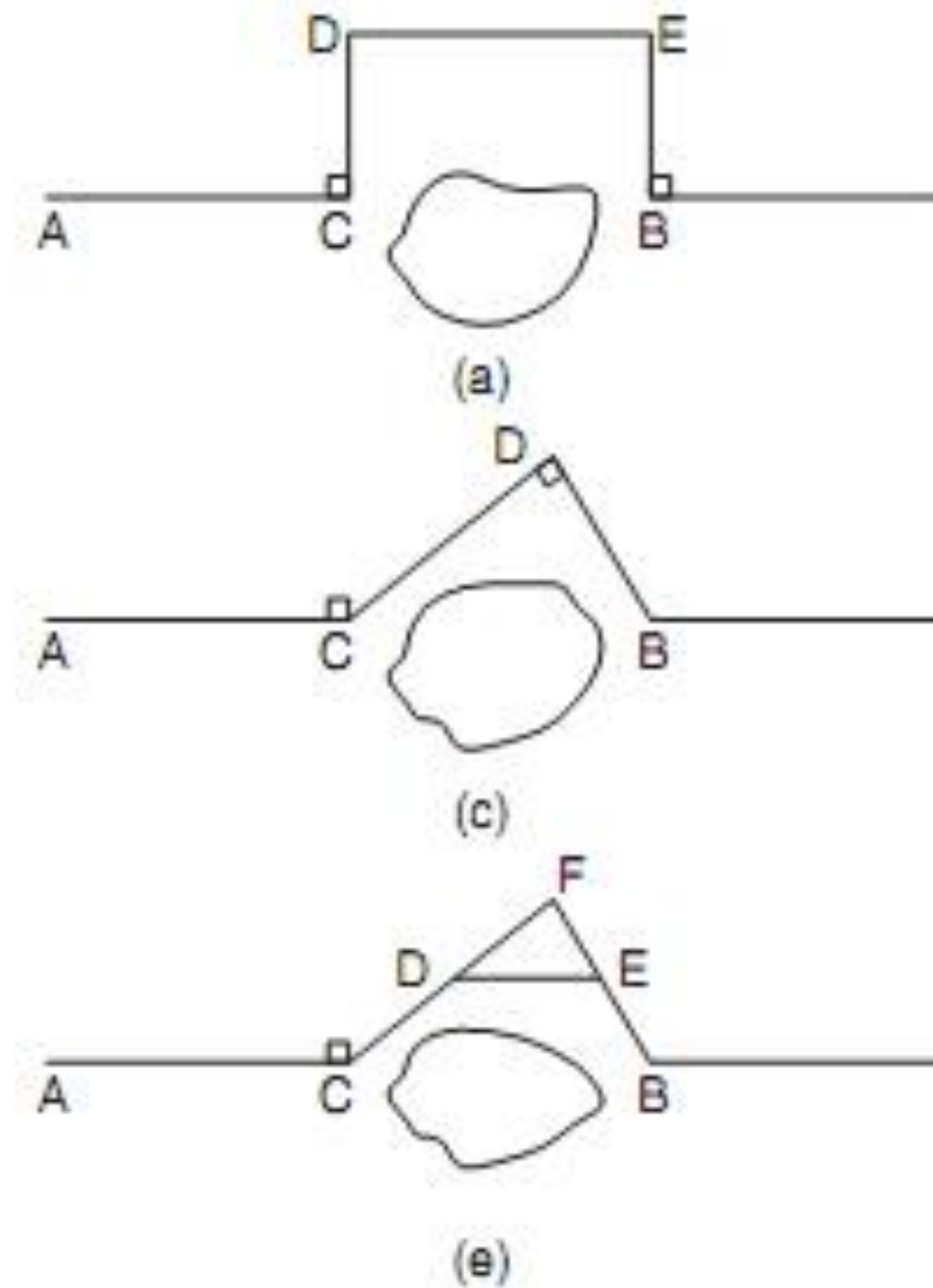

Measuring a Distance Across a River

Here, the obstacle (a river) cannot be avoided, but you can see the points you need to measure from both sides of the river. There are several methods, based on geometry, which can be used.

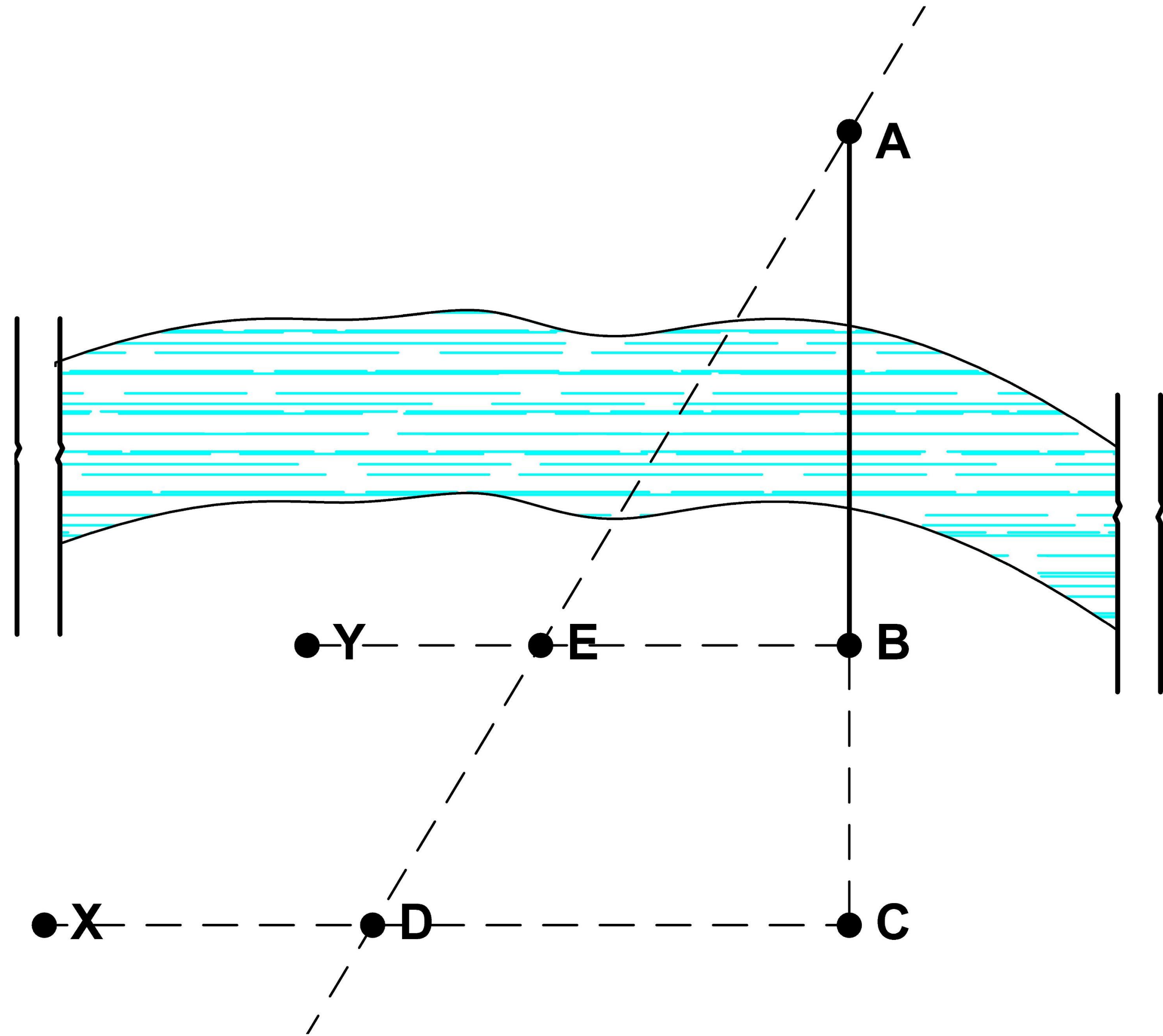

Method 1

- Using ranging poles, prolong line AB back to point C.
At B and C, lay out perpendiculars BY and CX.
- On each of these lines, set out a point, D and E, so that they lie on a straight line DA passing through A, on the opposite bank.
- Measure accessible distances BE, BC and CD.
- Calculate the inaccessible distance BA from similar triangles.

$$\overline{DC} = \text{measured} \quad \overline{EB} = \text{measured} \quad \overline{CB} = \text{measured}$$

$$\frac{\overline{DC}}{\overline{CA}} = \frac{\overline{EB}}{\overline{BA}} \rightarrow \quad \overline{CA} = \frac{\overline{DC} \times \overline{BA}}{\overline{EB}} \rightarrow \quad \overline{BA} = \overline{CA} - \overline{CB}$$

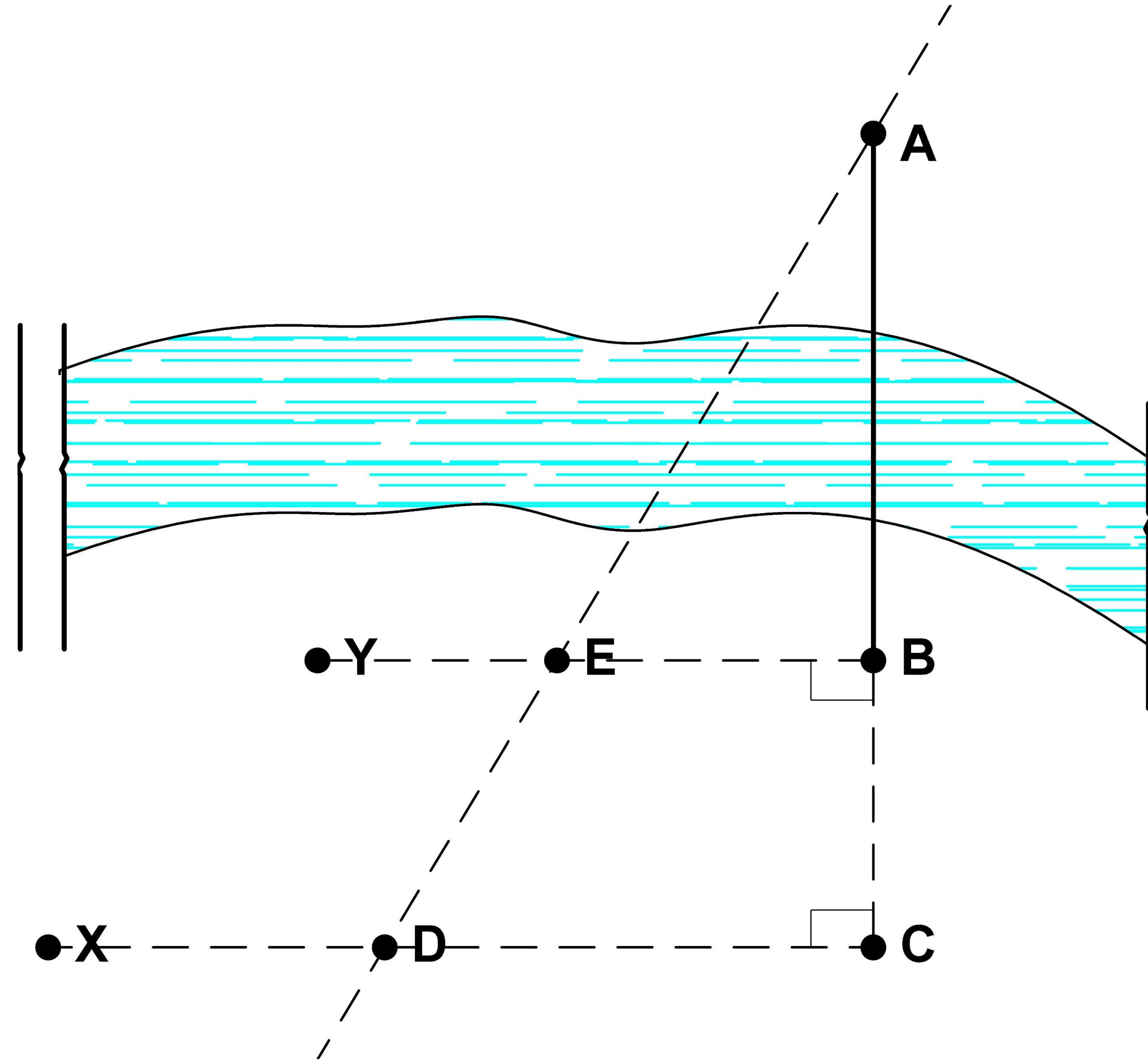

Method 2

- Layout line BX perpendicular to AB on one river bank.
- Determine the point C of this perpendicular from which you will be able to sight point A across the river, using a 45-degree angle.
- Measure distance CB, which is equal to inaccessible distance AB

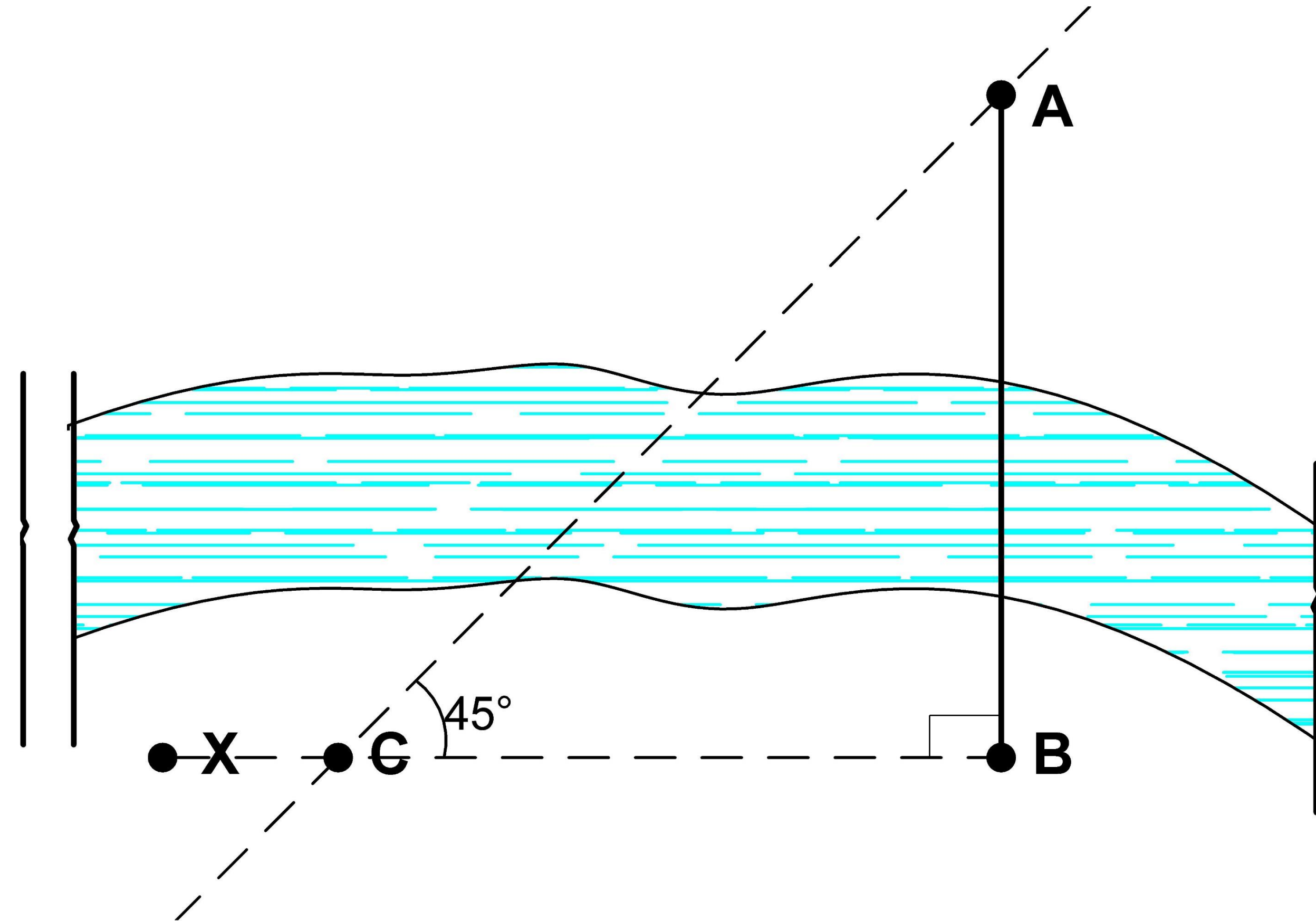

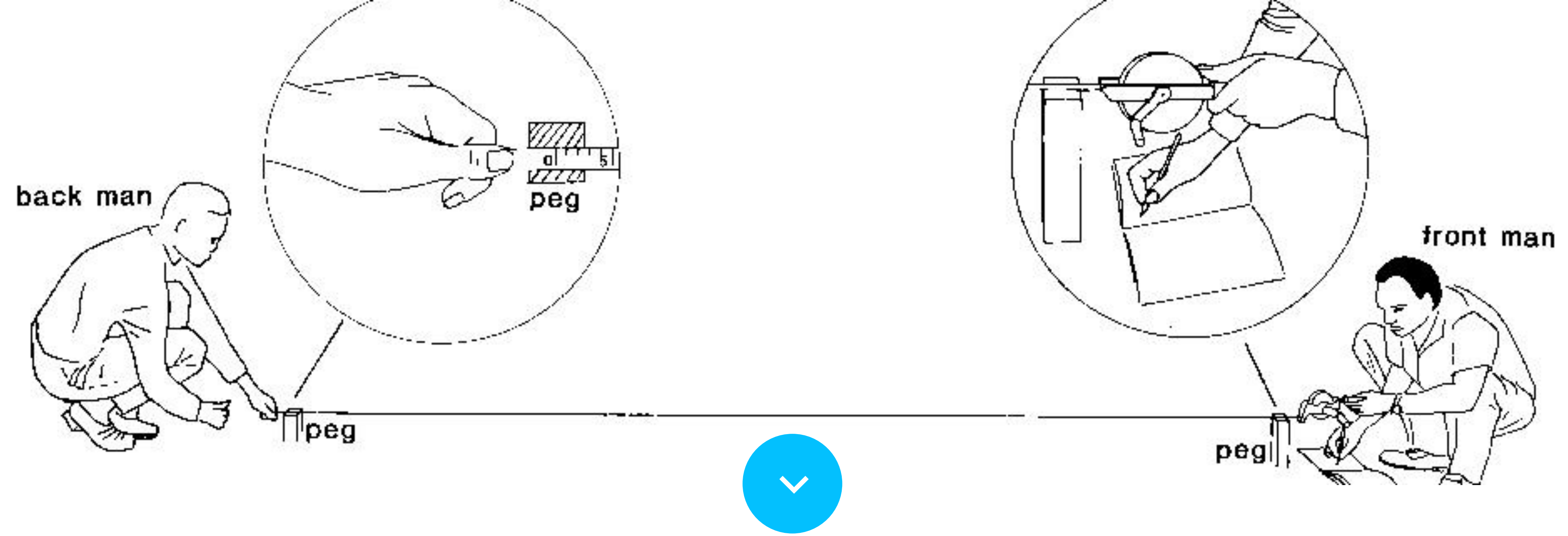

Types of Errors in Spatial Measurements



Mistakes (blunders)

large notable errors that can be detected by repeating measurements. One should be careful during reading and booking observations to avoid these errors. These mistakes are omitted using statistical approach.

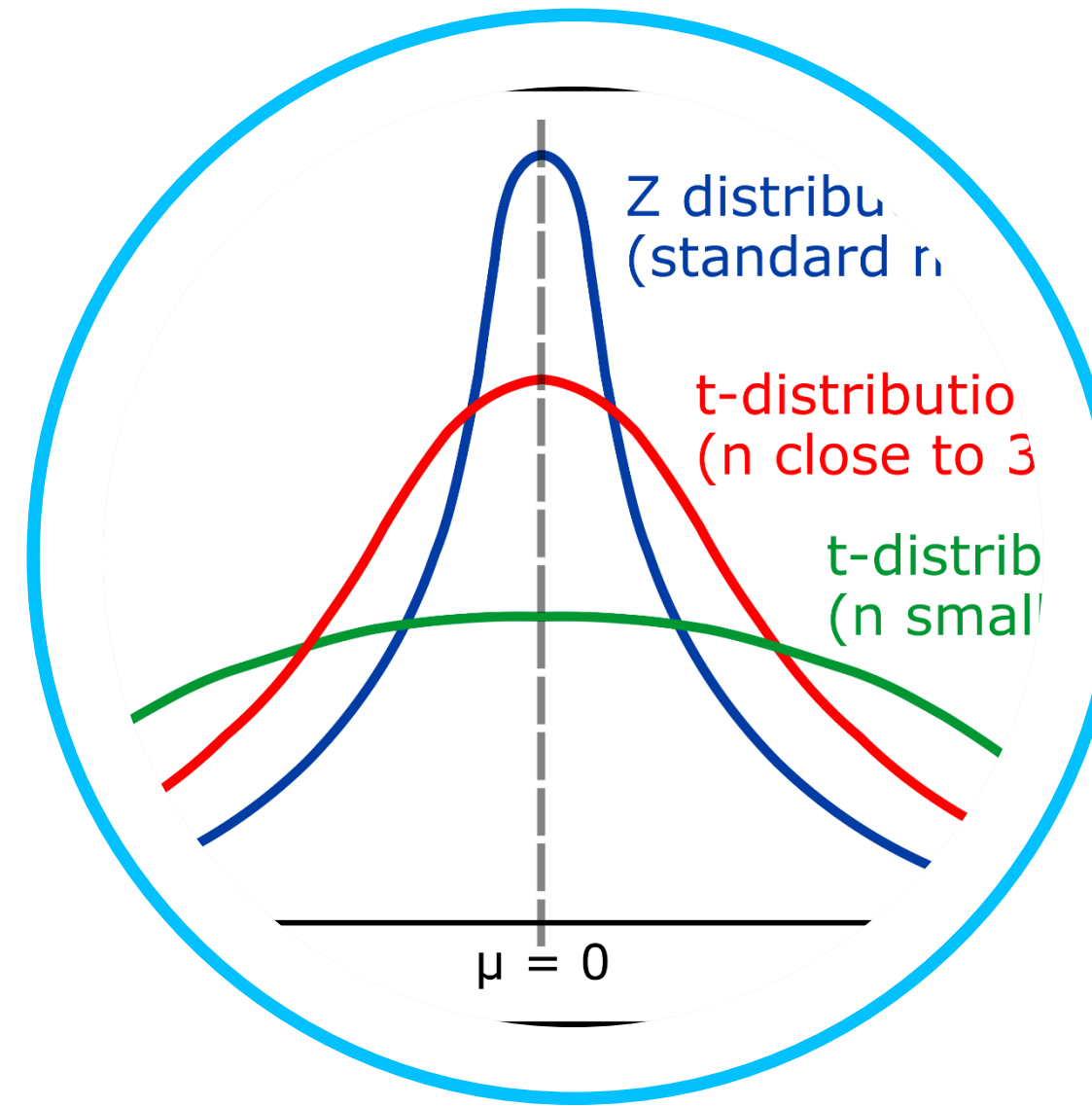

Systematic Errors

These are caused by physical sources, like weather changes. They can be reduced by applying math models appropriate to the error source.



Random Errors

These are called residuals. These are the errors remaining after reducing systematic errors. They are dealt with statistically in what is called adjustment of observations.

Sources of Errors in Spatial Measurements

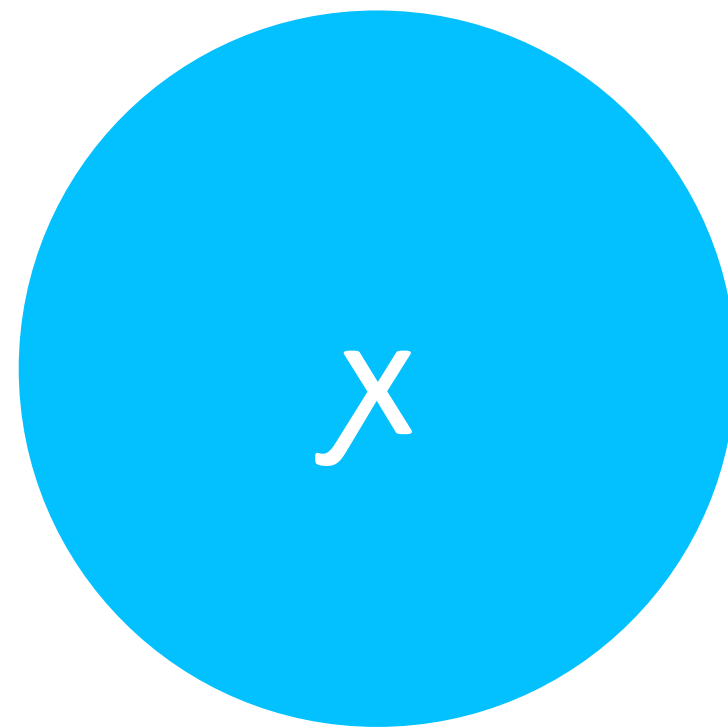

Natural Errors

Errors may also be due to variations in natural phenomena such as temperature, humidity, wind, refraction and magnetic declination. If it is not properly observed while taking measurements, the results will be incorrect.

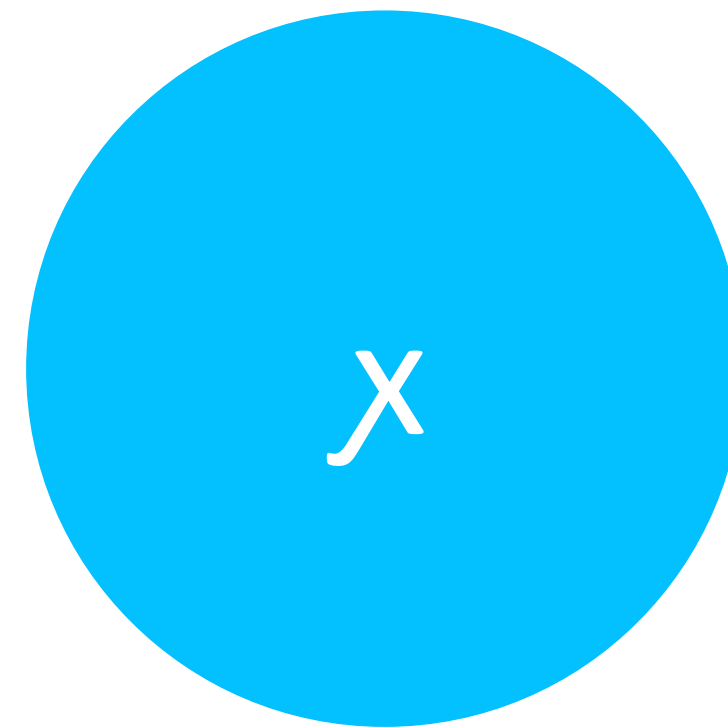

Instrumental errors

Error may arise due to imperfection or faulty adjustment of the instrument with which measurement is being taken.

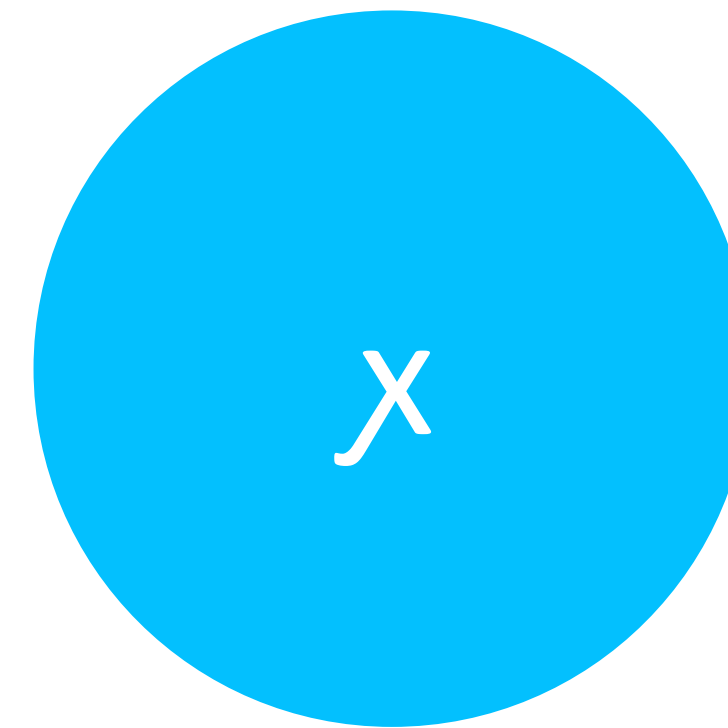

Personal Error

Error may also arise due to want of perfection of human sight in observing and of touch in manipulating instruments.

Tape Measurement Errors

In surveying, tape correction(s) refer(s) to specific mathematical technique(s) used to apply corrections into a taping operation after removing mistakes or blunders by repeating observations several times. Tape correction is applied to systematic or instrument errors or combination of both.



Correction Due to Incorrect Tape Length (Standardization Correction)

- Manufacturers of measuring tapes do not usually guarantee their tape products. Nominal length of tapes were often not true due to physical imperfections like stretching, wear and temperature changes, causing tape length error. Standardization of tape is therefore required.
- The correction due to error in tape length is given by:
- $C = (L_t - L_n)$ per tape length, where:
- $L_t =$ standardized or true length of tape, $L_n =$ nominal length of tape (e.g 50, 100m)
- standardization correction for one meter measured $= C/L_n = (L_t - L_n)/L_n$
- If distance measured is L_m , total correction for distance, $C_T = [(L_t - L_n)/L_n] * L_m$
- Corrected distance $L_c = L_m + C_T = L_m(L_t/L_n)$
- Note that incorrect tape length introduces systematic error that must be calibrated periodically.

Correction Due to Incorrect Tape Length (Standardization Correction)

• Where

• C : correction per tape length

• L_t : true length of tape

• L_n : nominal length of tape

• C_{1m} : standardization correction for one meter

• L_m : distance measured

• C_T : total correction for distance

• L_c : Corrected distance

correction per tape length →

$$C = L_t - L_n$$

correction per one meter →

$$C_{1m} = \frac{L_t - L_n}{L_n}$$

correction per total distance →

$$C_T = \left(\frac{L_t - L_n}{L_n} \right) \times L_m$$

corrected distance →

$$L_C = L_m + C_T$$

corrected distance →

$$L_C = L_m \left(\frac{L_T}{L_n} \right)$$

Correction to slope

Correction due to slope. C_h is the correction of height due to slope, θ is the angle formed by the slope line oriented from the horizontal ground, S is the measured slope distance between two points on the slope line, h is the height difference between the two end points of the measured line, d is the required horizontal distance.

When distances are measured along the slope, then the equivalent horizontal distance may be determined by applying the following slope correction.

$$d = S \cdot \cos \theta \quad (\text{given the elevation angle } \theta)$$
$$d = [S^2 - h^2]^{1/2} \quad (\text{given elevation difference } h)$$

The correction can be directly given as: $C_h = S (1 - \cos \theta)$

The obtained correction C_h is subtracted from S to obtain the corrected tape length of the horizontal distance between two points on the slope line: $d = S - C_h$

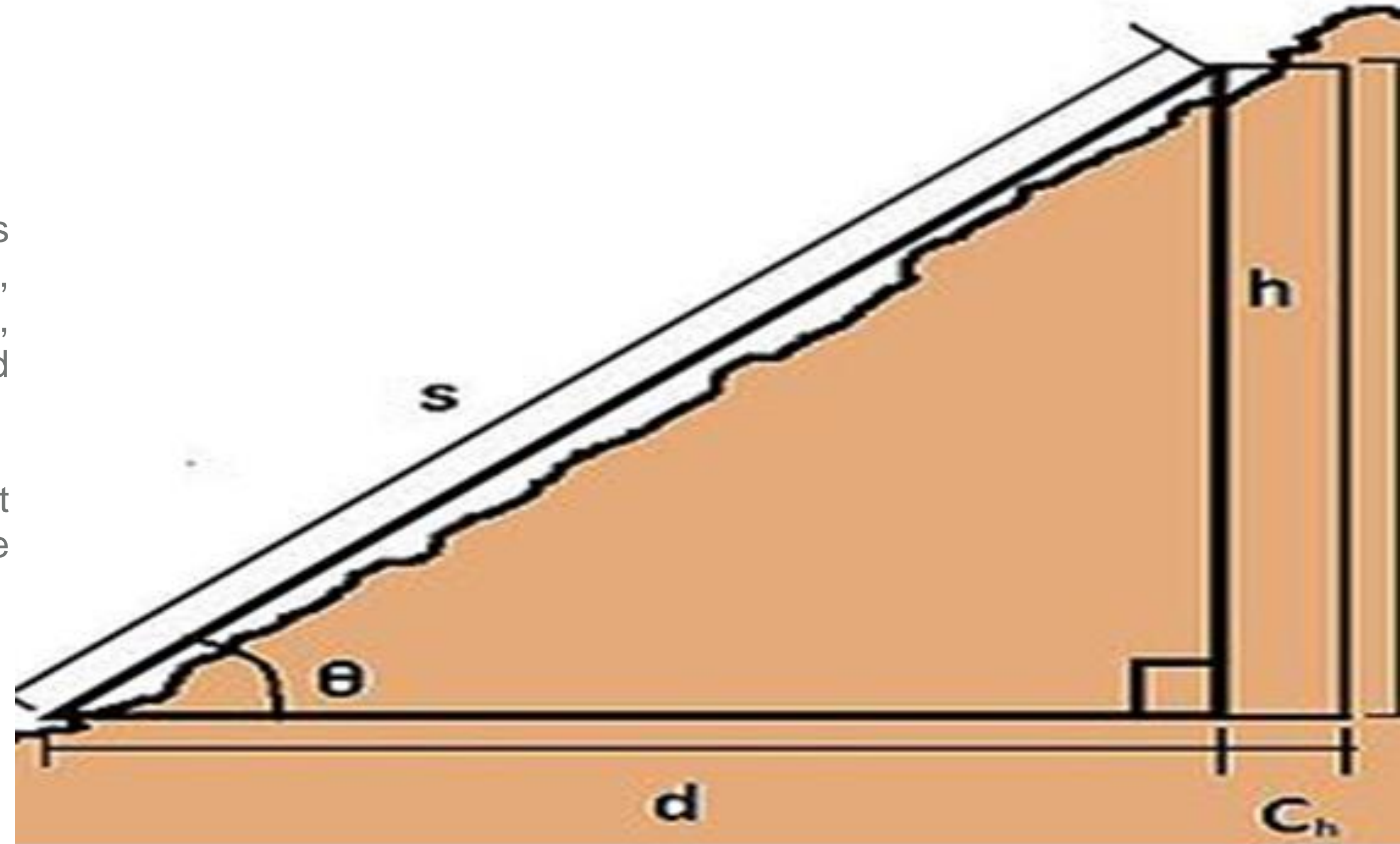

Correction to Temperature Change

- The correction of the tape length due to change in temperature is given by:
- $C_t = C * L * (T - T_s)$
- Where:
 - C_t is the correction to be applied to the tape due to temperature;
 - T is the observed temperature or average observed temperature at the time of measurement;
 - T_s is the temperature at which the tape was standardized;
 - C is the coefficient of thermal expansion of the tape;
 - L is the length of the tape or length of the line measured.
- Usually, for common tape measurements, the tape used is a steel tape. Therefore, the coefficient of thermal expansion C is equal to 0.0000116 per degree Celsius. It means that the tape stretched by 0.0000116 units for every rise of one degree Celsius temperature.

Correction to Tension

- The correction due to tension variation between standardization and field is given by:
- $C_p = (P_m - P_s) * L / (A * E)$
- Where:
 - C_p is the total elongation in tape length due to pull; or the correction to be applied due to incorrect pull applied on the tape; meters;
 - P_m is the pull applied on the tape during measurement; kilograms;
 - P_s is the pull applied on the tape during standardization; kilograms;
 - A is the cross-sectional area of the tape; square centimeters;
 - E is the modulus of elasticity of the tape material; kilogram per square centimeters;
 - L is the measured or erroneous length of the line; meters
- The value for A is given by: $A = W / (L * U_w)$
- Where:
 - W is the total weight of the tape; kilograms;
 - U_w is the unit weight of the tape; kilogram per cubic centimeter.
- In steel tapes, the value for U_w is given by $7.866 \times 10^{-3} \text{ kg/cm}^3$

Correction to Sag

- When the tape, on the other hand, is not properly pulled it begins to sag, The correction due to sag is given by:
- $C_s = w^2 L^3 / (24 P^2)$
- Where:
- C_s is the correction applied to the tape due to sag; meters;
- w is the weight of the tape per unit length; kilogram per meters;
- L is the interval length between two supports or unsupported lengths of the tape; meters;
- P is the tension or pull applied to the tape that causes it to sag; kilogram.
- Note that the weight of the tape per unit length is equal to the actual weight of the tape divided by the length of the tape:
- $w = W / L$ And $W = w L$
- $C_s = W^2 L / (24 P^2)$

Example

A distance AB is measured using a tape of 20m nominal length. Recorded distance is 65.32m. When checked against standard, the tape was found to be 50mm too long.

- a) Compute: 1-correction to distance AB, 2-corrected distance AB.
b) if point A is 2.00m higher than B, compute the horizontal distance AB.

Solution:

Nominal length of tape = 20.00m, Standardized (true) length of tape = $20.00 + 0.05 = 20.05\text{m}$

Standardization correction for AB = $(0.05/20.00) \times 65.32 = 0.16\text{m}$

Corrected distance AB = $65.32 + 0.16 = 65.48\text{m}$

Horizontal distance AB = $(65.48^2 - 2.00^2)^{1/2} = 65.45\text{m}$