



**Manufacturing Processes (2), IE-352**  
**Ahmed M El-Sherbeeney, PhD**  
**Spring 2014**

**Manufacturing Engineering Technology in SI Units, 6<sup>th</sup> Edition**

**Chapter 22:**  
**Cutting-Tool Materials and Cutting Fluids**

# Chapter Outline

2

1. Introduction
2. Cutting Tool Materials
  1. High-speed Steels
  2. Cast-cobalt Alloys
  3. Carbides
  4. Coated Tools
  5. Alumina-based Ceramics
  6. Cubic Boron Nitride
  7. Silicon-nitride-based Ceramics
  8. Diamond
  9. Whisker-reinforced Materials and Nanomaterials
3. Tool Costs and Reconditioning of Tools
4. Cutting Fluids



# Introduction

3

- Cutting tool is subjected to –as mentioned before– :
  1. High temperatures,
  2. High contact stresses
  3. Rubbing along the tool–chip interface and along the machined surface
- Cutting-tool material must possess:
  1. **Hot hardness** (see right)
    - ▣ compare ceramics vs. carbon steels
  2. **Toughness and impact strength**
  3. **Thermal shock resistance**
  4. **Wear resistance**
  5. **Chemical stability and inertness** (e.g. no adhesion)

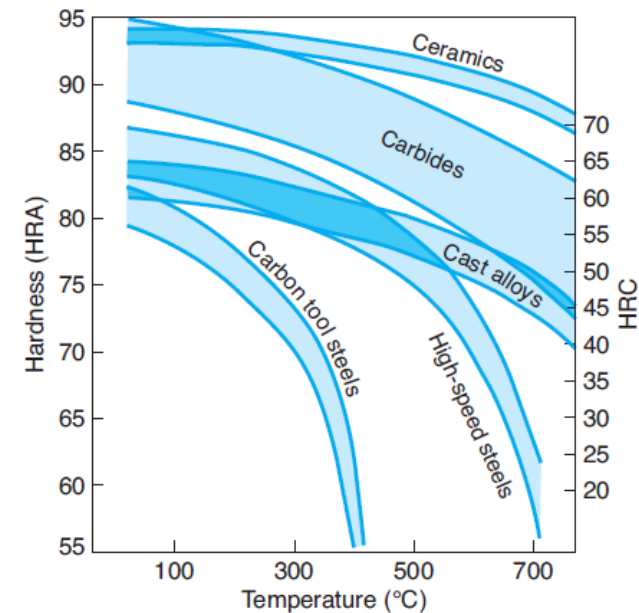

# Introduction

4

- Tool materials -see next 3 slides- may not have all of the desired properties for a particular machining operation:
  - **Hardness, strength:** ensure good mechanical properties of workpiece material
  - **Impact strength:** important for interrupted cuts (e.g. milling)
  - **Melting temperature:** important for tool material due to high temp. generated in cutting zone
  - **Physical properties** (e.g. thermal conductivity, coefficient of thermal expansion): ensure tool resistance to thermal fatigue, shock
  - Compare (for example) in [slide 6](#),
    - High speed steels: high toughness, but low hot hardness
    - Ceramics: high resistance to temp. & wear, but brittle and can chip
    - Diamonds: hardest material, but most expensive

# Introduction

5

## General Characteristics of Tool Materials

Property	High-speed steels	Cast-cobalt alloys	Carbides		Ceramics	Cubic boron nitride	Single-crystal diamond*
			WC	TiC			
Hardness	83–86 HRA	82–84 HRA 46–62 HRC	90–95 HRA 1800–2400 HK	91–93 HRA 1800–3200 HK	91–95 HRA 2000–3000 HK	4000–5000 HK	7000–8000 HK
Compressive strength, MPa	4100–4500	1500–2300	4100–5850	3100–3850	2750–4500	6900	6900
Transverse rupture strength, MPa	2400–4800	1380–2050	1050–2600	1380–1900	345–950	700	1350
Impact strength, J	1.35–8	0.34–1.25	0.34–1.35	0.79–1.24	<0.1	<0.5	<0.2
Modulus of elasticity, GPa	200	—	520–690	310–450	310–410	850	820–1050
Density, kg/m <sup>3</sup>	8600	8000–8700	10,000–15,000	5500–5800	4000–4500	3500	3500
Volume of hard phase, %	7–15	10–20	70–90	—	100	95	95
Melting or decomposition temperature, °C	1300	—	1400	1400	2000	1300	700
Thermal conductivity, W/m K	30–50	—	42–125	17	29	13	500–2000
Coefficient of thermal expansion, $\times 10^{-6}/^{\circ}\text{C}$	12	—	4–6.5	7.5–9	6–8.5	4.8	1.5–4.8

\*The values for polycrystalline diamond are generally lower, except for impact strength, which is higher.

# Introduction

6

**General Characteristics of Cutting-tool Materials (These Tool Materials Have a Wide Range of Compositions and Properties; Overlapping Characteristics Exist in Many Categories of Tool Materials)**

	High-speed steels	Cast-cobalt alloys	Uncoated carbides	Coated carbides	Ceramics	Polycrystalline cubic boron nitride	Diamond
Hot hardness	→						
Toughness	←						
Impact strength	←						
Wear resistance	→						
Chipping resistance	←						
Cutting speed	→						
Thermal-shock resistance	←						
Tool material cost	→						
Depth of cut	Light to heavy	Light to heavy	Light to heavy	Light to heavy	Light to heavy	Light to heavy	Very light for single-crystal diamond
Processing method	Wrought, cast, HIP <sup>‡</sup> sintering	Cast and HIP sintering	Cold pressing and sintering	CVD or PVD <sup>†</sup>	Cold pressing and sintering or HIP sintering	High-pressure, high-temperature sintering	High-pressure, high-temperature sintering

Source: After R. Komanduri.

<sup>‡</sup>Hot-isostatic pressing.

<sup>†</sup>Chemical-vapor deposition, physical-vapor deposition.

# Introduction

## General Operating Characteristics of Cutting-tool Materials

Tool materials	General characteristics	Modes of tool wear or failure	Limitations
High-speed steels	High toughness, resistance to fracture, wide range of roughing and finishing cuts, good for interrupted cuts	Flank wear, crater wear	Low hot hardness, limited hardenability, and limited wear resistance
Uncoated carbides	High hardness over a wide range of temperatures, toughness, wear resistance, versatile, wide range of applications	Flank wear, crater wear	Cannot use at low speeds because of cold welding of chips and microchipping
Coated carbides	Improved wear resistance over uncoated carbides, better frictional and thermal properties	Flank wear, crater wear	Cannot use at low speeds because of cold welding of chips and microchipping
Ceramics	High hardness at elevated temperatures, high abrasive wear resistance	Depth-of-cut line notching, microchipping, gross fracture	Low strength and low thermomechanical fatigue strength
Polycrystalline cubic boron nitride (cBN)	High hot hardness, toughness, cutting-edge strength	Depth-of-cut line notching, chipping, oxidation, graphitization	Low strength, and low chemical stability at higher temperature
Diamond	High hardness and toughness, abrasive wear resistance	Chipping, oxidation, graphitization	Low strength, and low chemical stability at higher temperatures

Source: After R. Komanduri and other sources.

# Introduction

- Tool Materials (also used for dies and molds in casting, forming, and shaping metallic and non-metallic materials):
  1. High-speed steels
  2. Cast-cobalt alloys
  3. Carbides
  4. Coated tools
  5. Alumina-based ceramics
  6. Cubic boron nitride
  7. Silicon-nitride-based ceramics
  8. Diamond
  9. Whisker-reinforced materials and nanomaterials
- Tools materials are discussed here in terms of:
  - characteristics, applications, limitations, optimal performance



# High-speed Steels

9

- *High-speed steel* (HSS) tools were developed to machine at higher speeds than was previously possible
  - compared to carbon steels (low hot hardness  $\Rightarrow$  low speeds)
- Can be hardened to various depths, have good wear resistance and are inexpensive
- Suitable for: high +ve rake angle tools, interrupted cuts, machines subject to vibration/chatter, complex tools
- Biggest drawback: low cutting speed ( $V$ ) vs carbide tools
- Two basic types of HSS:
  - **molybdenum** (*M-series*: 10%  $Mo$ ; other alloys:  $Cr$ ,  $V$ ,  $W$ ,  $Co$ ): higher abrasion resistance than T-series, less distortion during heat treatment, less expensive  $\Rightarrow$  comprise 95% of HSS
  - **tungsten** (*T-series*: 12-18%  $W$ ; other alloys:  $Cr$ ,  $V$ ,  $Co$ )



# High-speed Steels

10

- High-speed steel tools are available in:
  - ▣ wrought (rolled or forged)
  - ▣ cast
  - ▣ powder-metallurgy (sintered) forms
- They can be treated to improve performance:
  - ▣ Coating (discussed later)
  - ▣ Surface treatment (to improve hardness, wear resistance)
  - ▣ Steam treatment (reduce tendency of BUE formation)



# Cast-cobalt Alloys

11

- *Cast-cobalt alloys* (mostly *Co*, also: *Cr*, *W*): have,
  - ▣ high hardness
  - ▣ good wear resistance
  - ▣ maintain hardness at elevated temperatures (hot hardness)
- Drawbacks
  - ▣ not as tough as HSS
  - ▣ sensitive to impact forces
  - ▣ ⇒ less suitable than HSS for interrupted cutting operations
- Applications: used as *Stellite* tools, used for
  - ▣ Deep (large  $t_0$ ), roughing cuts (high  $f$  &  $V$ : *twice larger* > HSS)
  - ▣ Removing large material (little concern for surface finish)



# Carbides

12

- AKA *cemented/sintered carbides* (since 1930's)
- Characteristics of carbides:
  1. **High hardness** over a wide range of temperatures (&  $V$ )
    - compared to HSS & Cast-Co alloys where only low  $V$  possible
  2. High elastic modulus
  3. High thermal conductivity
  4. Low thermal expansion
  5. Versatile
  6. Cost-effective tool & die materials for many applications
- 2 groups used in machining (AKA uncoated carbides)
  - Tungsten Carbide
  - Titanium Carbide



# Carbides: Tungsten Carbide

13

- *Tungsten carbide* (WC) consists of tungsten-carbide particles bonded together in a cobalt matrix (i.e. sintering)
  - ▣ particle size is 1-5  $\mu\text{m}$
  - ▣ particles are pressed and sintered into desired “insert” shapes
- As Co content increases (typically: 6-16%),
  - ▣ strength, hardness, and wear resistance of WC ↓
  - ▣ yet toughness ↑ because of the higher toughness of Co
- Applications:
  - ▣ Cutting steels, cast irons, abrasive nonferrous materials
  - ▣ Have largely replaced HSS due to better performance

# Carbides: Titanium Carbide

14

- Consists of a nickel–molybdenum matrix
- wear resistance > tungsten carbide, but is not as tough
- Applications:
  - machining hard materials (steels and cast irons)
  - cutting at speeds > those suitable for tungsten carbide

# Carbides: Inserts

15

- High-speed steel tools (i.e. traditional tools):
  - 1-piece; shaped for applications: drill bits, milling, gear cutters
  - When cutting edge wears  $\Rightarrow$  tool must be replaced and sharpened, which is a time-consuming and inefficient process
- *Inserts*: individual cutting tools with several cutting points
  - e.g. Square insert: 8 cutting points (how?)
  - Triangular insert: 6 cutting points

**Typical carbide inserts with various shapes and chip-breaker features; note the complex chip breaking features on inserts**

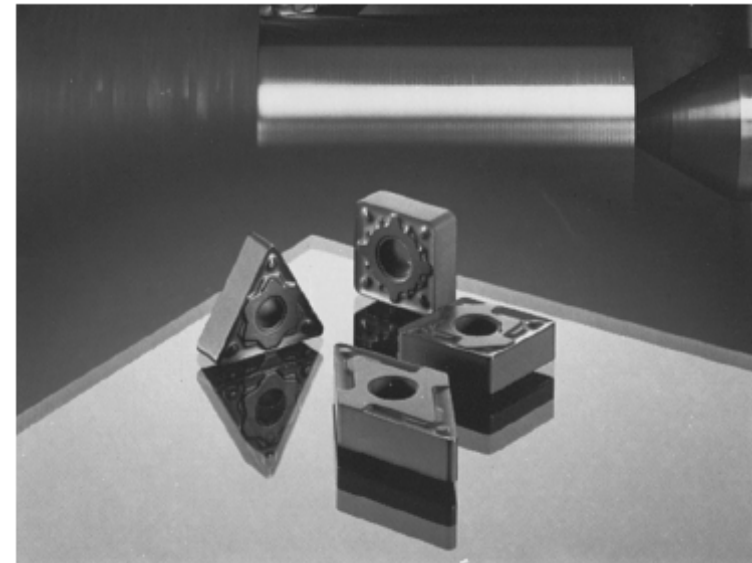

# Carbides: Inserts

16

- Various locking mechanisms for inserts are used (below)
- Clamping is the preferred method of securing an insert
  - A particular edge is first used, then when edge is worn:
  - insert is **indexed** (rotated in its holder) to make another cutting point available

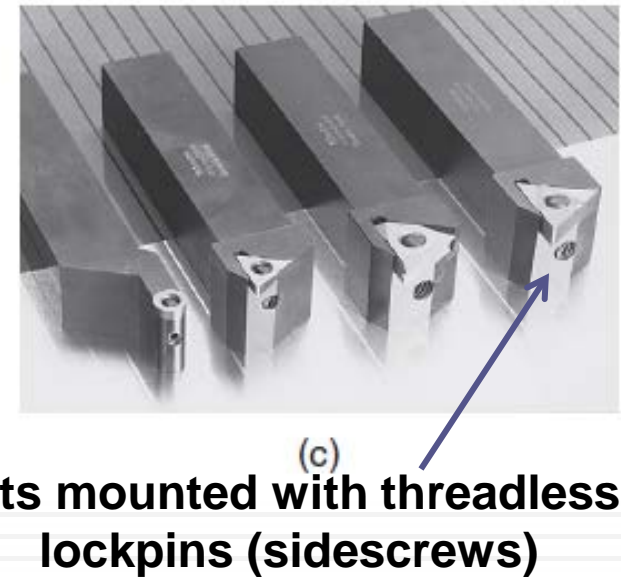
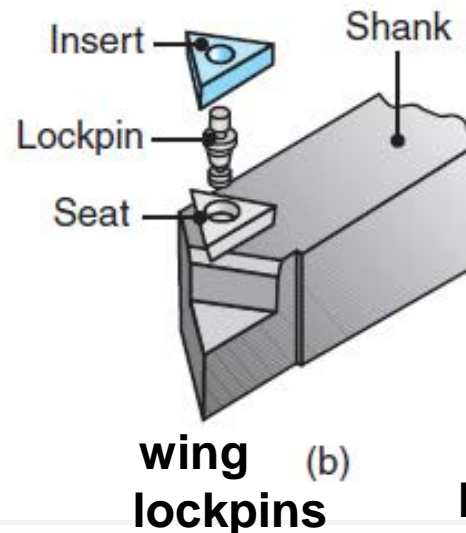
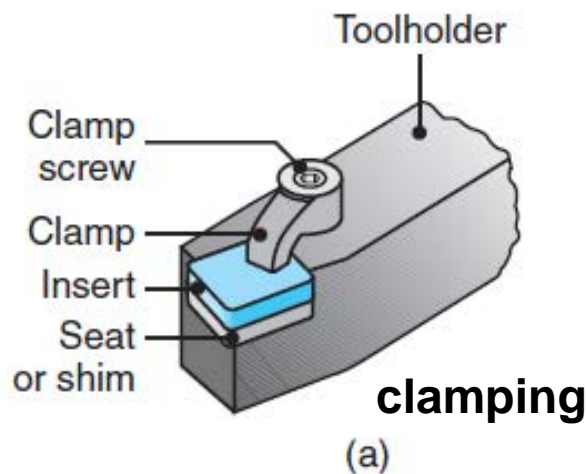



# Carbides: Inserts

17

- Carbide inserts: available in variety of shapes
  - square, triangle, diamond, round (see below)
- Strength of insert depends on its shape
  - as included angle of cutting edge  $\downarrow \Rightarrow$
  - strength of the edge also  $\downarrow$  and its chipping and breaking  $\uparrow$

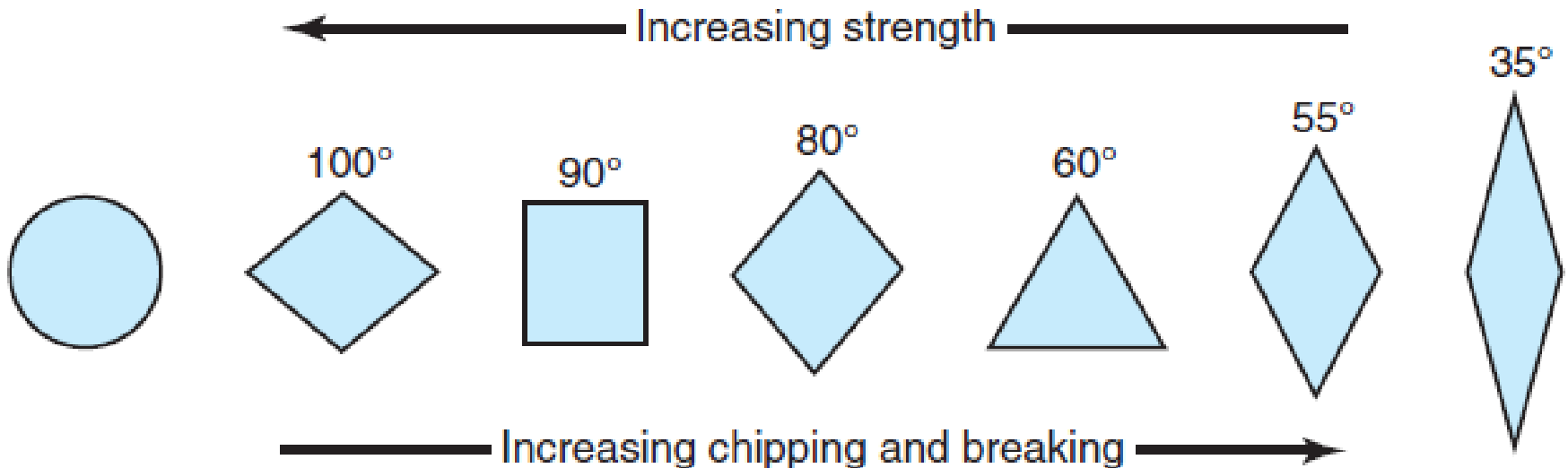

# Carbides: Inserts

18

- Insert edges are usually
  - ▣ honed, chamfered, produced with negative land (see below)
  - ▣ this improves edge strength
  - ▣ hone radius: about 0.025 *mm*

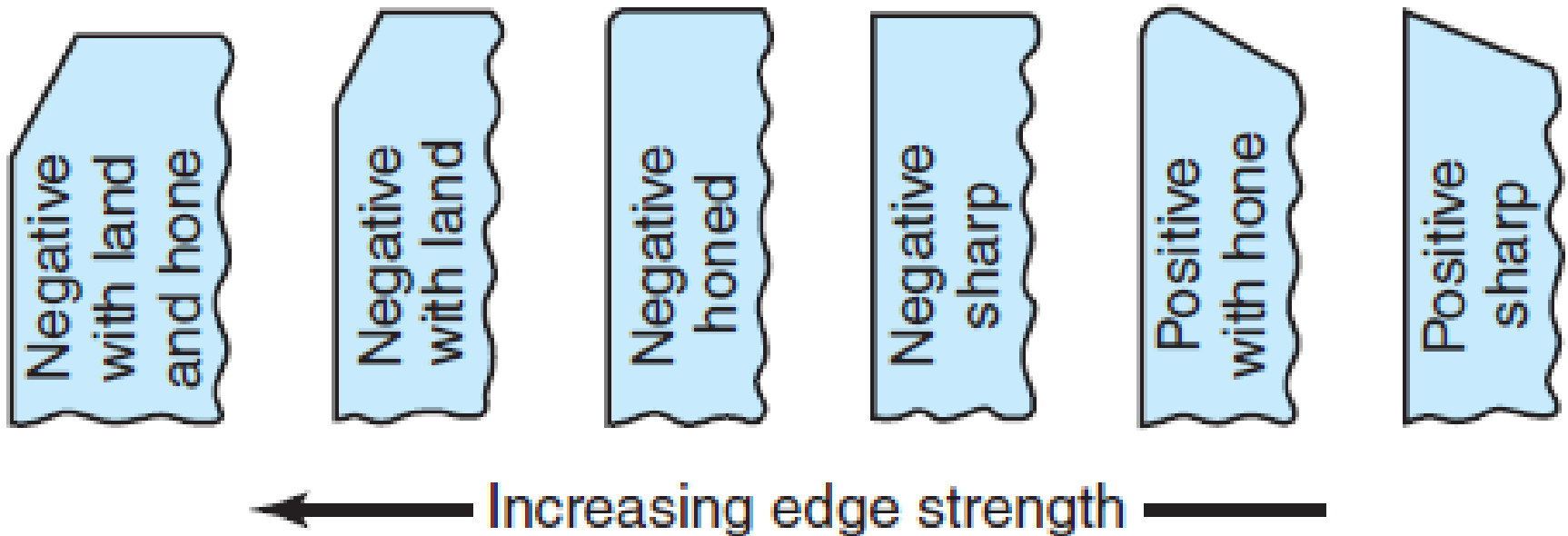

# Carbides: Inserts

19

- **Chip-breaker** features on inserts (previous chapter)
  1. Control chip flow during machining
  2. Eliminate long –continuous– chips
  3. Reduce vibration and heat generated
- Selection of chip-breaker feature ([slide 15](#)) depends on
  - $f$ ,  $t_o$ , workpiece material, type of chip, roughing or finishing cut
- **Stiffness** of the machine tool is important
  - small  $f$  and  $V$ , and chatter are v. harmful to tool cutting edge
  - light  $f$ : concentrate forces & temp. at tool edge  $\Rightarrow$  chipping
  - small  $V \Rightarrow$  cold welding of chip to tool
  - $\Rightarrow$  cutting fluids needed in large, continuous amounts to minimize heating and cooling in interrupted cutting

# Carbides: Classification of Carbides

20

- ISO (International Organization for Standardization):
  - standards for carbide grades: classified using letters P, M, K
  - difficult task due to various machining applications, materials
- ANSI: other classification (C1-C8), depending on material

## ISO Classification of Carbide Cutting Tools According to Use

Symbol	Workpiece material	Color code	Designation in increasing order of wear resistance and decreasing order of toughness in each category (in increments of 5)
P	Ferrous metals with long chips	Blue	P01, P05–P50
M	Ferrous metals with long or short chips, nonferrous metals	Yellow	M10–M40
K	Ferrous metals with short chips, nonferrous metals, nonmetallic materials	Red	K01, K10–K40

# Coated Tools

21

- New alloys and engineered materials
  - developed to have high strength and toughness (since 1960's)
  - problem: abrasive, chemically reactive with tool materials
  - Difficulty in machining these materials  $\Rightarrow$  rise of coated tools
- Coatings have unique properties:
  1. Lower friction
  2. Higher adhesion
  3. Higher resistance to wear and cracking
  4. Acting as a diffusion barrier
  5. Higher hot hardness and impact resistance



# Coated Tools

22

- Coated tools:
  - ▣ Tools lives up to 10X > uncoated tools
  - ▣  $\Rightarrow$  allows higher  $V \Rightarrow$  reduced operation time & production costs
  - ▣ machining time dropped by < 100 times since 1900 (see ↓)
  - ▣ Used now in 40-80% of all machining (esp. turning, milling, drilling)

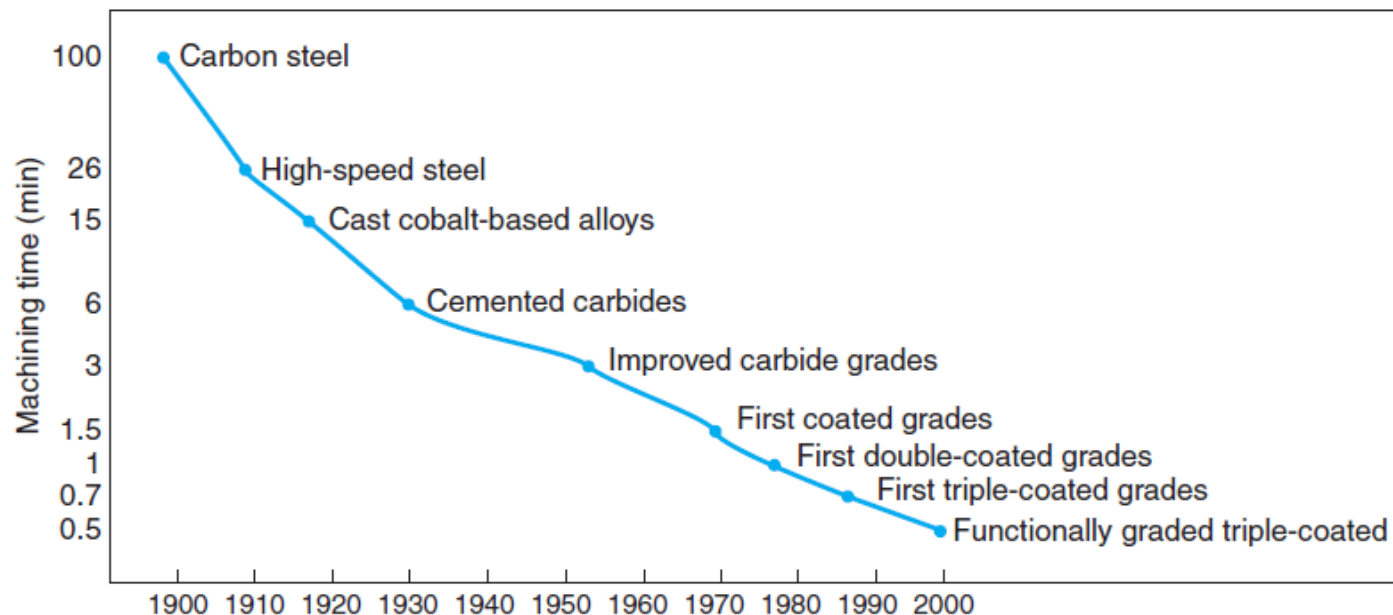

# Coated Tools:

## Coating Materials and Coating Methods

23

- Common coating materials are:
  1. Titanium nitride (TiN)
  2. Titanium carbide (TiC)
  3. Titanium carbonitride (TiCN)
  4. Aluminum oxide ( $\text{Al}_2\text{O}_3$ )
- Coatings usually have sizes: 2-15  $\mu\text{m}$

# Coated Tools:

## Coating Materials and Coating Methods

24

- Techniques for applying coating on cutting tools & inserts:
    1. **Chemical-vapor deposition (CVD)**
      - used most with multiphase coating & ceramic tools (later)
    2. **Physical-vapor deposition (PVD)**
      - PVD-coated carbides with TiN coating ⇒
        - Higher cutting-edge strength
        - Lower friction
        - Lower tendency to form BUE
        - Smoother and more uniform thickness (2-4  $\mu\text{m}$ )
- (note, how this covers all aspects of higher machinability in last chapter)*



# Coated Tools:

## Coating Materials and Coating Methods

25

- Coatings for tools should have following characteristics:
  1. **High hardness:** at high temp  $\Rightarrow$  resist wear
  2. **Chemical stability** and **inertness** to workpiece  $\Rightarrow$  resist wear
  3. **Low thermal conductivity:**  $\Rightarrow$  prevent rise in tool temp.
  4. **Compatibility and good bonding** to substrate (i.e. tool material)  $\Rightarrow$  prevent flaking
  5. **Little or no porosity** in coating  $\Rightarrow$  high strength and integrity
- Additional enhancements to coating:
  - ▣ Using substrate with high hardness, toughness
  - ▣ Honing cutting edges to avoid peeling of coating at edges

# Coated Tools:

## Coating Materials and Coating Methods

26

### Titanium-nitride Coatings

- Have low friction coefficients, high hardness, resistance to high temperature, and good adhesion to substrate
- Improve the life of high-speed steel tools and improve the lives of carbide tools, drill bits, and cutters
- Perform well at higher cutting speeds and feeds
- Flank wear « in uncoated tools (see right)
- Flank surface can be reground after use without removing coating on rake face

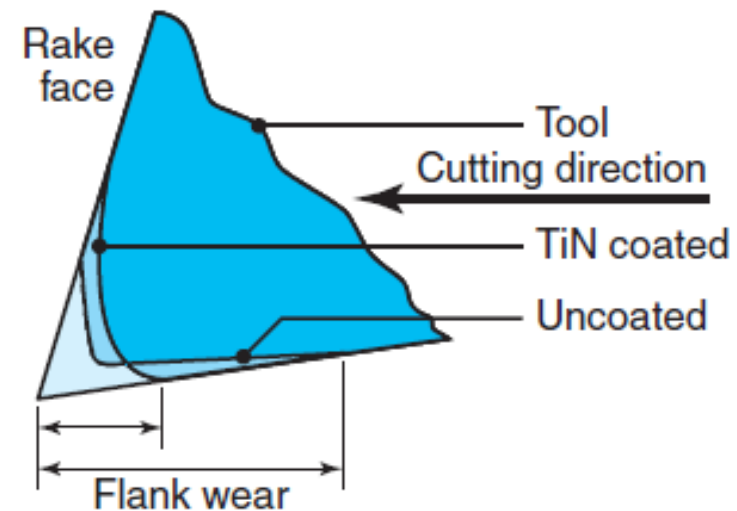



# Coated Tools:

## Coating Materials and Coating Methods

27

### Titanium-carbide Coatings

- Coatings have high flank-wear resistance in machining abrasive materials (used with WC inserts)

### Ceramic Coatings

- Ceramic serve well as coating material since
  - ▣ chemically inert
  - ▣ have low thermal conductivity,
  - ▣ resist high temperature,
  - ▣ resist flank and crater wear

# Coated Tools:

## Coating Materials and Coating Methods

28

### Multiphase Coatings

- Desirable properties of coatings can be combined & optimized with use of *multiphase coatings*
- e.g. carbide tools with 3 layers
  - ▣ **TiC** to bond with substrate (bottom)
  - ▣ **Al<sub>2</sub>O<sub>3</sub>** to bond well and be compatible with layer on top & bottom
  - ▣ **TiN** to resist wear & have low thermal conductivity (top)
  - ▣ usually used to machine cast iron or steel

# Coated Tools:

## Coating Materials and Coating Methods

29

### Alternating Multiphase Coatings

- Size of each coating layer: 2-10  $\mu\text{m}$
- Note, thinner coating  $\Rightarrow$  grain size  $\downarrow \Rightarrow$  hardness  $\uparrow$
- Inserts can have as many as 13 alternating layers

**TiN:** low friction

**Al<sub>2</sub>O<sub>3</sub>:** therm. stability

**TiCN:** resists flank + crater wear

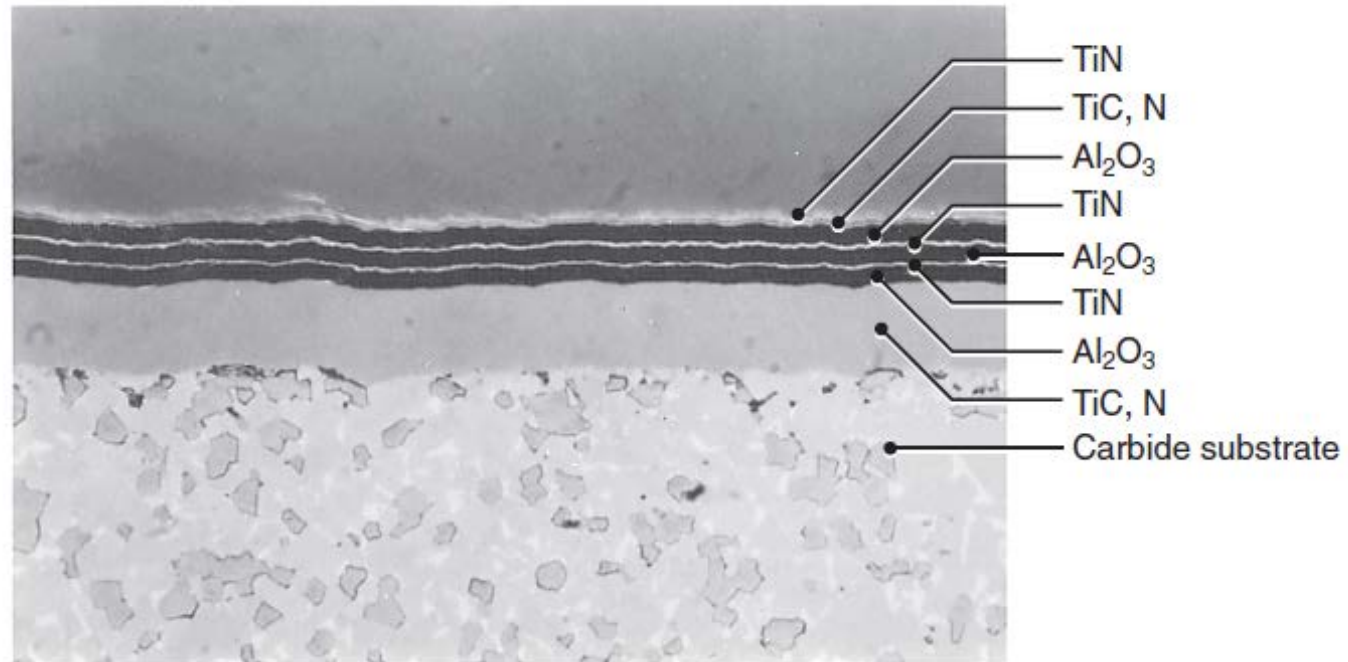

# Coated Tools:

## Miscellaneous Coating Materials

30

- **Polycrystalline diamond coating**
  - used especially with WC and SiN inserts
  - used to machine abrasive, nonferrous metals (e.g. Al)
- **Titanium carbonitride (TiCN) and titanium-aluminum nitride (TiAlN):** effective in cutting stainless steels
- **Chromium carbide (CrC)** used to machine softer metals that adhere to cutting tool (e.g. Al, Cu, Ti)
- More recent developments are **nanolayer coatings** and **composite coatings**
  - Hardness almost as high as cBN
  - Still in experimental phase
  - Expected to have wide applications in machining

# Coated Tools: Ion Implantation

31

- Ions are introduced into the surface of the cutting tool, improving its surface properties
- Process does not change the dimensions of tools
- **Nitrogen-ion** implanted carbide tools have been used successfully on alloy steels and stainless steels

# Alumina-based Ceramics

32

## □ Ceramic tool materials

- consist of fine-grained and high-purity **aluminum oxide**
- additions of titanium carbide and zirconium oxide improve toughness and thermal shock resistance
- ceramic inserts used in high-speed cutting (e.g. turning)

## □ *Alumina-based ceramic* tools

- high abrasion resistance
- more inert than HSS & carbides  $\Rightarrow$  less BUE (?)
- $\Rightarrow$  produce good surface finish with cast iron
- have low toughness  $\Rightarrow$  tend to chip prematurely

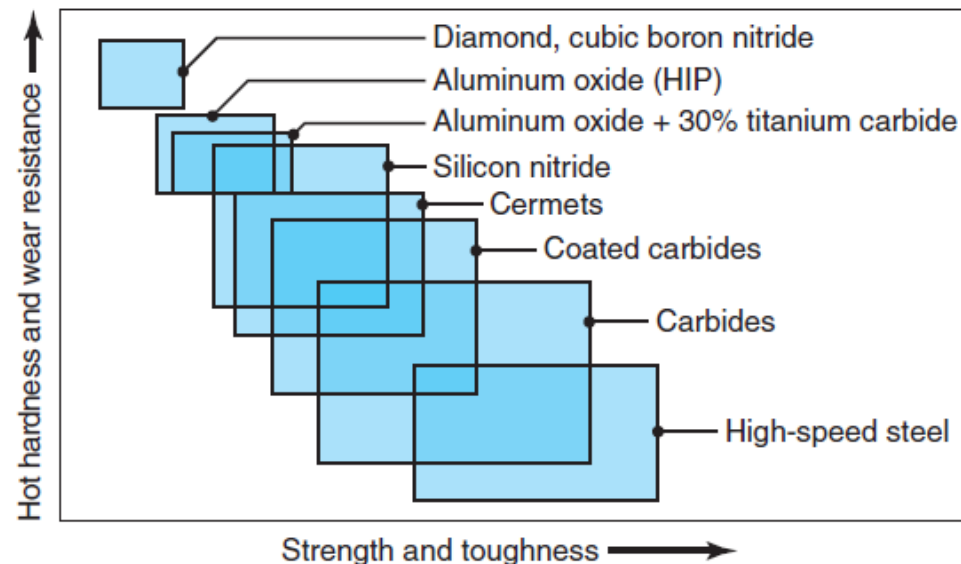



# Alumina-based Ceramics

## Cermets

- Introduced in 1960's
- Consist of *ceramic* particles in a *metallic* matrix
- e.g. cermet: 70%  $\text{Al}_2\text{O}_3$  + 30% TiC
- Have high chemical stability and resistance to BUE formation
- But they are brittle, expensive and have limited usage
- Performance is between ceramics and carbides
- Application: high-speed finishing cuts

# Cubic Boron Nitride

34

- *Cubic boron nitride (cBN)*: hardest material after diamond
  - Carbide (substrate) provides shock resistance
  - cBN layer provides v. high wear resistance & cutting-edge strength
- At high temperatures, it is chemically inert to Fe & nickel
- Its resistance to oxidation is high
- Suitable for cutting hardened ferrous and high-temp alloys, and for high-speed machining
- But: brittle, so machine must be stiff to resist vibrations

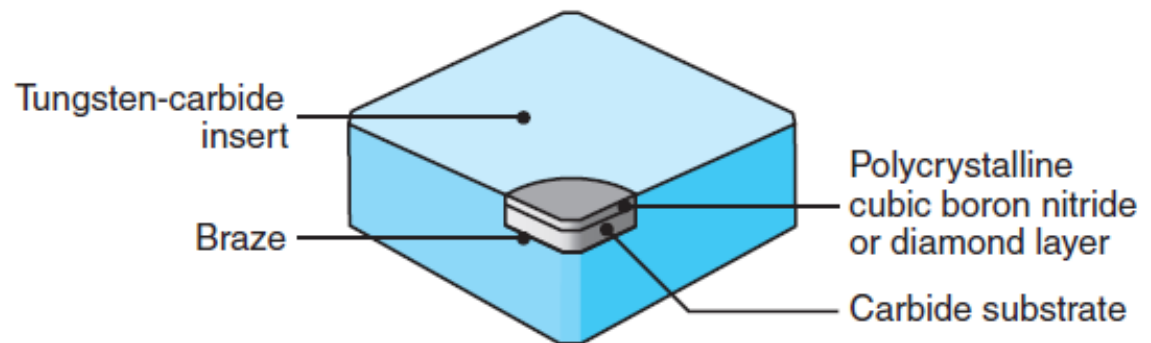

# Silicon-nitride-based Ceramics

35

- *Silicon-nitride* (SiN) based ceramic tool materials consist of silicon nitride with various additions of aluminum oxide, yttrium oxide and titanium carbide
- Tools have:
  - ▣ high toughness
  - ▣ hot hardness
  - ▣ good thermal-shock resistance
- Due to chemical affinity to iron at elevated temperature, SiN-based tools are not suitable for machining steels



# Diamond

36

- Diamond: hardest of all known substances
- Properties:
  - low friction
  - high wear resistance
  - ability to maintain a sharp cutting edge
  - result in good surface finish and high dimensional accuracy
  - best used with soft nonferrous alloys
  - also used with abrasive nonmetallic and metallic materials
- *Synthetic* or industrial *diamonds* are used since natural diamond has flaws and performance can be unpredictable



# Diamond

37

- As diamond is brittle, tool shape and sharpness are important
  - ▣ low rake angle must be used to provide strong cutting edge
  - ▣ proper mounting should be used for optimum tool life
  - ▣ best used with light, uninterrupted finishing cuts
  - ▣ tool must be resharpened as soon as it becomes dull (to minimize fracture)

**top row:** Inserts with polycrystalline cBN tips

**bottom row:** Solid polycrystalline cBN inserts

**Note:** these are similar to diamond tools

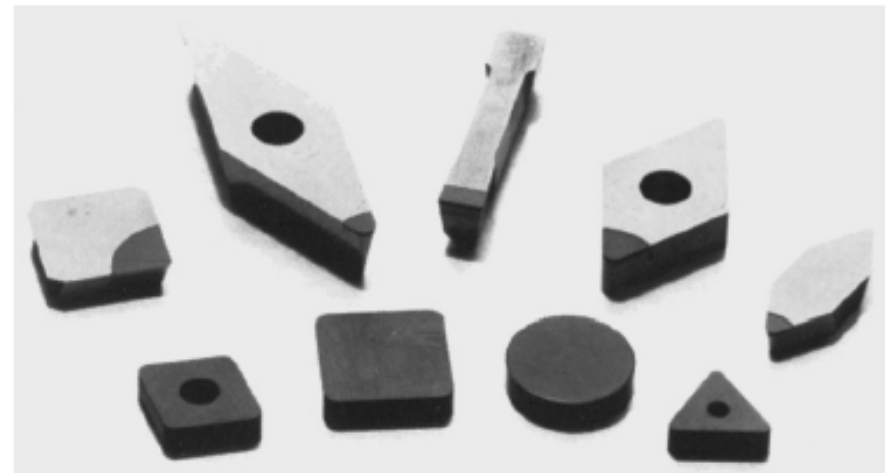

# Whisker-reinforced Materials and Nanomaterials

38

- Continuous effort to improve tool performance, increase wear resistance, and enhance properties:
  1. High fracture toughness
  2. Resistance to thermal shock
  3. Cutting-edge strength
  4. Creep resistance
  5. Hot hardness
- *Whiskers*: used for reinforcing fibers in composite tools
  - e.g. Si-carbide whiskers: 5-100  $\mu\text{m}$  long, diameter: 0.1-1  $\mu\text{m}$
- *Nanomaterials*: also becoming important in tools
  - e.g. carbides, ceramics; applied as thin coating
  - Increase tool life without coolant (i.e. dry machining)



# Tool Costs and Reconditioning of Tools

39

- *Tool costs* depend on: tool material, size, shape, chip-breaker features and quality; e.g. (12.5-*mm* insert):
  - uncoated carbide: \$5-10 (cheapest)
  - diamond-tipped: \$90-125 (most expensive)
- Cost of individual insert is relatively insignificant
  - tooling comprises only 2-4% of all machining costs
  - reason: single tool can be indexed and recycled
  - e.g. square insert with 1 edge lasting 30-60 min will last: ?\*
- Cutting tools can be **reconditioned** by resharpener
  - carried out manually, or cutter grinders, or comp.-controlled
- Reconditioning of coated tools also done by recoating
  - must make sure dimensions are same as original tool





# Cutting Fluids

40

- *Cutting fluids* used to:
  1. Reduce friction & wear ( $\Rightarrow$  improve tool life, surface finish)
  2. Cool the cutting zone ( $\Rightarrow$  improve tool life,  $\downarrow$  temperature)
  3. Reduce forces and energy consumption
  4. Flush chips from cutting zone (important in drilling)
  5. Protect machined surface from environmental corrosion
- Cutting fluid used as (depending on machining operation):
  - **coolant**, or **lubricant**, or both
  - e.g. water: excellent coolant (i.e. temp  $\downarrow$ ); but not effective lubricant (i.e. no  $\downarrow$  in friction); may also cause oxidation (rust)
- Effectiveness of cutting fluids depends on:
  - machining operation, tool & workpiece materials, cutting speed



# Cutting Fluids

41

## Cutting-fluid Action

- Cutting fluids move to tool-chip interface by
  - ▣ Seeping (i.e. slow penetration) from sides of the chip
  - ▣ *capillary action* of the “interlocking network of surface asperities” (i.e. unevenness) in the interface
- Cutting fluids should thus have
  - ▣ Small molecular size (for small capillary network)
  - ▣ Appropriate “wetting” (high surface tension)
  - ▣ e.g. using emulsions, low-weight oils suspended in water
- Discontinuous cutting operations:
  - ▣ have easier mechanisms for lubricant application
  - ▣ but the tools are more susceptible to thermal shock

# Cutting Fluids

42

## EXAMPLE 22.2

### Effects of Cutting Fluids on Machining

A machining operation is being carried out with a cutting fluid that is an effective lubricant. What will be the changes in the mechanics of the cutting operation if the fluid is shut off?

# Cutting Fluids

43

## Solution

### Effects of Cutting Fluids on Machining

Chain of events taking place after the fluid is shut off:

1. Friction at the tool–chip interface will increase
2. The shear angle will decrease in accordance
3. The shear strain will increase
4. The chip will become thicker
5. A built-up edge is likely to form

# Cutting Fluids

## Solution

### Effects of Cutting Fluids on Machining

As a result of these changes:

1. The shear energy in the primary zone will increase
2. The frictional energy in the secondary zone will increase
3. The total energy will increase
4. The temperature in the cutting zone will rise
5. Surface finish will deteriorate and dimensional tolerances may be difficult to maintain

# Cutting Fluids

45

## Types of Cutting Fluids (4 general types)

### 1. **Oils** (AKA *straight oils*)

- ▣ mineral, animal, vegetable, compounded, and synthetic oils
- ▣ used for: low-speed operations (i.e. no high ↑ in temperature)

### 2. **Emulsions** (AKA *soluble oils*)

- ▣ mixture of oil and water and additives
- ▣ used for: high-speed operations (i.e. high ↑ in temperature)
- ▣ water: acts as coolant; oils: reduces oxidation caused by water

### 3. **Semisynthetics**

- ▣ chemical emulsions + little water-diluted mineral oil + additives

### 4. **Synthetics**

- ▣ chemicals with additives, water-diluted, with no oil

# Cutting Fluids

46

## Methods of Cutting-fluid Application

- 4 basic methods

### 1. Flooding

- ▣ Most common method (see next slide)
- ▣ Typical rate: 10 L/min (single-point tools, as in turning) to 225 L/min (multiple point cutters, as in milling)
- ▣ Chips flushed with 700-14,000 *kPa* pressures

### 2. Mist

- ▣ Similar to spraying with aerosol can
- ▣ Allows better view of machined workpiece (compared to flooding)
- ▣ But has lower cooling capability
- ▣ Also: venting needed to prevent inhalation of particles

# Cutting Fluids

47

## Proper Methods of Applying Flooding (see below)

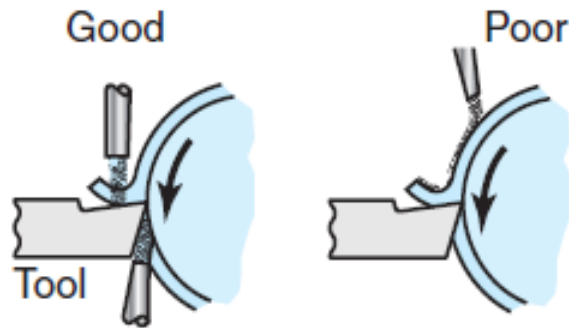

(a) turning

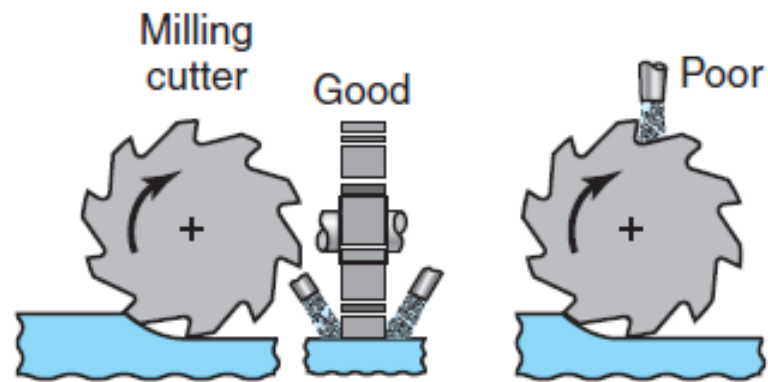

(b) milling

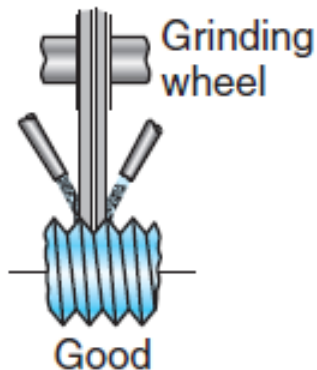

thread grinding (c)

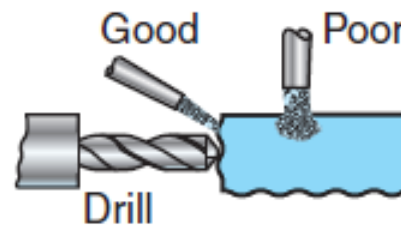

(d) drilling

# Cutting Fluids

48

## Cont. Methods of Cutting-fluid Application

### 3. High-pressure systems

- ▣ used to increase rate of heat removal from cutting zone
- ▣ nozzles: direct cutting fluid powerfully into relief (flank) face
- ▣ pressure used: 5.5-35 *MPa*
- ▣ may be used as chip-breaker (e.g. long, continuous chips)

### 4. Through the cutting tool system

- ▣ used when difficult to apply cutting fluid into the cutting zone
- ▣ narrow passage in cutting tool and tool holder
- ▣ used to supply cutting fluid under high pressure



# Cutting Fluids

## Effects of Cutting Fluids

- Selection of a cutting fluid is based on:
  1. Workpiece material and machine tools
    - ▣ Cutting fluids may react with machine tool components
    - ▣ Thus, must clean machined parts from cutting fluids residue
  2. Biological considerations
    - ▣ Machine-tool operator is in close proximity to cutting fluids
    - ▣ Thus, health effects is a primary concern
    - ▣ Mist, fumes, smoke, cutting fluid odors ⇒ skin reactions, respiratory problems
    - ▣ Progress made in ensuring the safe use of cutting fluids (e.g. by using [dry or near-dry machining](#))

# Cutting Fluids

50

## Cont. Effects of Cutting Fluids

- Selection of a cutting fluid is based on:
  3. Environment
    - ▣ Cutting fluids may change –chemically– over time & repeated use
    - ▣ Due to: environmental effects or contamination (e.g. metal chips)
    - ▣ Result: development of microbes (especially in presence of water)  
⇒ environmental hazard, decreased cutting fluid effectiveness
    - ▣ Recycling involves treatment of fluids with additives, agents, biocides, deodorizers and water treatment
    - ▣ Disposal must abide by local laws

# Cutting Fluids:

## Near-dry and Dry Machining

51

- Trend since mid-1990's to reduce cutting fluid usage
- Thus, rise of near-dry machining; advantages:
  - reducing health, environmental hazards of cutting fluids
  - reducing cost of maintenance, recycling, disposing of CF's
  - improving surface quality
- Near-dry cutting/machining (NDM)
  - application of fine mist of air–fluid mixture containing very small amount of cutting fluid (« then used in flooding)
  - also called minimum-quantity lubrication (MQL)
- *Dry machining*
  - effective for turning, milling on steels, steel alloys, cast irons
  - here chips flushed from cutting zone by pressurized air
  - i.e. air serves limited cooling & flushing, but no lubrication

# Cutting Fluids:

## Near-dry and Dry Machining

52

### Cryogenic Machining

- Using gases like *nitrogen* or *carbon dioxide* as a coolant
- Small-diam. nozzle injects liquid N<sub>2</sub> to cutting zone @ -200°C
- Tool life & hardness maintained ⇒ higher cutting speeds
- Also: chips are more brittle
- Machinability is, thus, generally increased
- Also, N<sub>2</sub> evaporates; i.e. no adverse environmental effect