

**ELECTROGRAVIMETRIC  
AND  
COULOMETRIC METHODS  
OF ANALYSIS**

# Electrogravimetry and Coulometry

- Based on an analysis that is carried out by passing an electric current for a sufficient length of time to ensure complete oxidation or reduction of the analyte to a single product of known composition
- Moderately sensitive, more accurate, require no preliminary calibration against standards  
i.e. Absolute analysis is possible

# **Electrogravimetry –**

The product is weighed as a deposit on one of the electrodes (the working electrode)

# **Coulometry -**

- The quantity of electrical charge needed to complete the electrolysis is measured
- Types of coulometric methods
  - ❖ **Controlled- potential coulometry**
  - ❖ **Coulometric titrimetry**

# Electrogravimetric Methods

- **Involve deposition of the desired metallic element upon a previously weighed cathode, followed by subsequent reweighing of the electrode plus deposit to obtain by difference the quantity of the metal**
- **Cd, Cu, Ni, Ag, Sn, Zn can be determined in this manner**
- **Few substances may be oxidized at a Pt anode to form an insoluble and adherent precipitate suitable for gravimetric measurement**  
e.g. oxidation of lead(II) to lead dioxide in  $\text{HNO}_3$  acid

- **Certain analytical separations can be accomplished**
  - Easily reducible metallic ions are deposited onto a mercury pool cathode
  - Difficult-to-reduce cations remain in solution

Al, V, Ti, W and the alkali and alkaline earth metals may be separated from Fe, Ag, Cu, Cd, Co, and Ni by deposition of the latter group of elements onto mercury

Electrogravimetric  
methods

```
graph LR; A[Electrogravimetric methods] --> B[Constant applied potential (no control of the working electrode potential)]; A --> C[Controlled working electrode potential];
```

Constant applied potential  
(no control of the working  
electrode potential)

Controlled working electrode  
potential

# Constant applied potential electrogravimetry

- Potential applied across the cell is maintained at a constant level throughout the electrolysis
- Need a simple and inexpensive equipment
- Require little operator attention
- Apparatus consists of
  - I). a suitable cell
  - II). a direct- current power supply

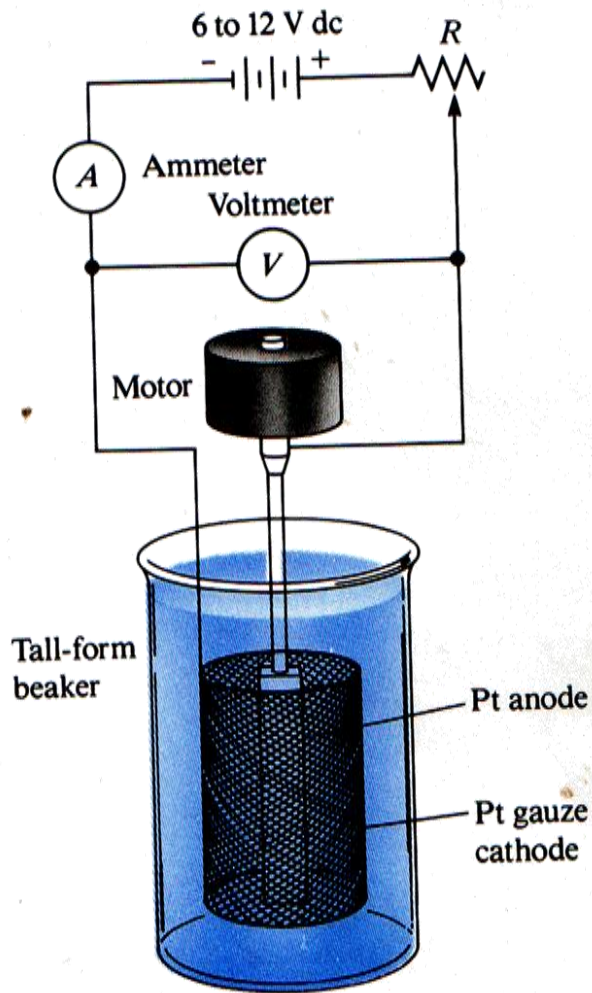

Apparatus for the electrodeposition of metals at constant applied potential

- The voltage applied to the cell is controlled by the rheostat, R



# The physical properties of electrolytic precipitates

- Ideally, an electrochemically deposited metal should be strongly adherent, dense and smooth
- So that it can be washed, dried and weighed without mechanical loss or reaction with the atmosphere
- The factors influencing the physical characteristics of deposits are:
  - I). current density
  - II). temperature
  - III). presence of complexing agents

- Stirring improves the quality of a deposit
- The effects of temperature are unpredictable and must be determined empirically
- Many metals form smoother and more adherent films when deposited from solutions in which their ions exist primarily as complexes  
e.g. Cyanide and ammonia complexes

# Applications

- Limited to the separation of easily reduced cations from those that are more difficult to reduce than hydrogen ion or nitrate ion

e.g. Assume that the original concentration of copper(II) in 1 M sulfuric acid is 0.01 M and that 2.0 to 2.5 V is impressed across the electrochemical cell

**Cathodic process** - Reduction of cupric ion at a copper-plated Pt electrode



**Anodic process** - oxidation of water

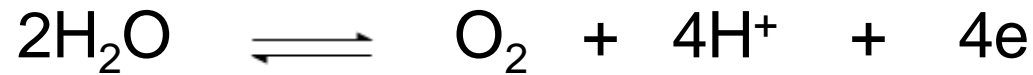

- Assumption – Surface concentration of cupric ion is 0.01 M at the start of electrolysis because the solution is well stirred, and that the activation potential is negligible.
- The potential of the cathode at the moment deposition of copper metal begins;

$$E_{\text{Cu}^{2+},\text{Cu}} = E^0_{\text{Cu}^{2+},\text{Cu}} - \frac{0.059}{2} \log \frac{1}{[\text{Cu}^{2+}]}$$

$$E_{\text{Cu}^{2+},\text{Cu}} = 0.337 - \frac{0.059}{2} \log \frac{1}{[0.01]}$$

$$= +0.28 \text{ v VS. NHE}$$

- During the first minute, potential of the copper cathode changes only slightly from its original value of +0.28 V
- Within only a few minutes,
  - Most of the cupric ion is reduced to the elemental state
  - Concentration of cupric ion at the electrode surface and in the bulk of the solution begins to decrease rapidly
- Therefore, the potential of the cathode shifts abruptly toward a value at which another reaction can maintain the current

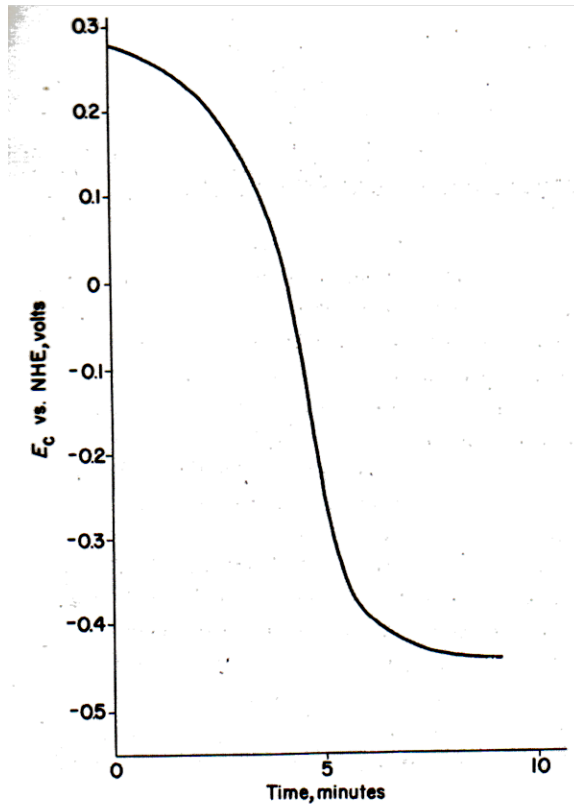

Schematic variation of potential of copper-plated platinum cathode during deposition of copper by electrolysis at constant applied potential

- Potential of the cathode decreases rapidly after about 5 minutes to  $\sim (-0.3 \text{ V})$  and a slower drop to a final value near  $-0.44 \text{ V}$
- Any further potential is halted by the steady evolution of hydrogen gas at the copper-plated Pt electrode

# Controlled working electrode potential electrogravimetry

- The potential of the working electrode is controlled
- Apparatus consists of two independent electrical circuits that share a common electrode (working electrode) at which the analyte is deposited

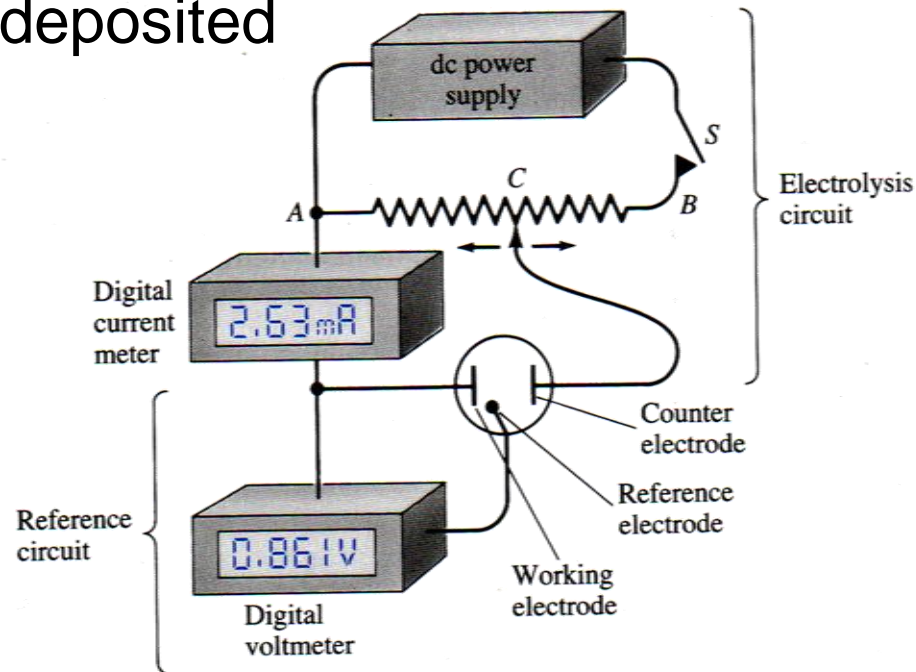

Apparatus for controlled potential electrogravimetry

- **The electrolysis circuit consists of:**
  - I). A dc source
  - II). A potential divider - permits continuous variation in the potential applied across the WE
  - III). A counter electrode
  - IV). A current meter
- **The control circuit consists of :**
  - I). A reference electrode (often a saturated calomel electrode)
  - II). A high-resistance digital voltmeter
  - III). A working electrode



Control circuit – monitor continuously the potential between the WE and the RE

e.g. Consider the copper(II) system described above  
Potential time behavior of the Cu cathode

- Larger the constant current, the shorter will be the time required to complete the deposition of copper
- If an unusually high current is employed,  
it is impossible for cupric ions alone to sustain the desired rate of electron transfer

- As soon as electrolysis begins, a significant fraction of the total current will be due to evolution of H<sub>2</sub> gas
- Formation of H<sub>2</sub> gas can be eliminated through the use of a **cathodic depolarizer**
- An example for a cathodic depolarizer – Nitric acid (nitrate ions undergoes an eight-electron reduction to ammonium ion at a more positive potential than the reduction of hydrogen ion)



# Applications

- Separating and determining metallic species having standard potentials that differ by only a few tenths of a volt  
e.g. Cu, Bi, Pb, Cd, Zn and Sn in mixtures by successive deposition of the metals on a weighed Pt cathode

# Coulometric Methods

- Measure the quantity of electrical charge (electrons) required to convert a sample of an analyte quantitatively to a different oxidation state
- Coulometric procedures are;
  - I. rapid
  - II. do not require the product to be weighable solid
  - III. as accurate as conventional gravimetric and volumetric procedures
  - IV. readily automated

# The quantity of electrical charge

- Units – Coulomb (C), Faraday (F)
- The coulomb is the quantity of electrical charge transported by a constant current of one ampere in one second
- The number of coulombs (Q) resulting from a constant current of I amperes operated for t seconds is;

$$Q = It$$

- For a variable current  $I$ , the number of coulombs is given by;

$$Q = \int_0^t I dt$$

- The faraday is the quantity of charge that correspond to one mole or  $6.022 \times 10^{23}$  electrons

$$1 \text{ Faraday} = 96485 \text{ C}$$

# Types of Coulometric Methods

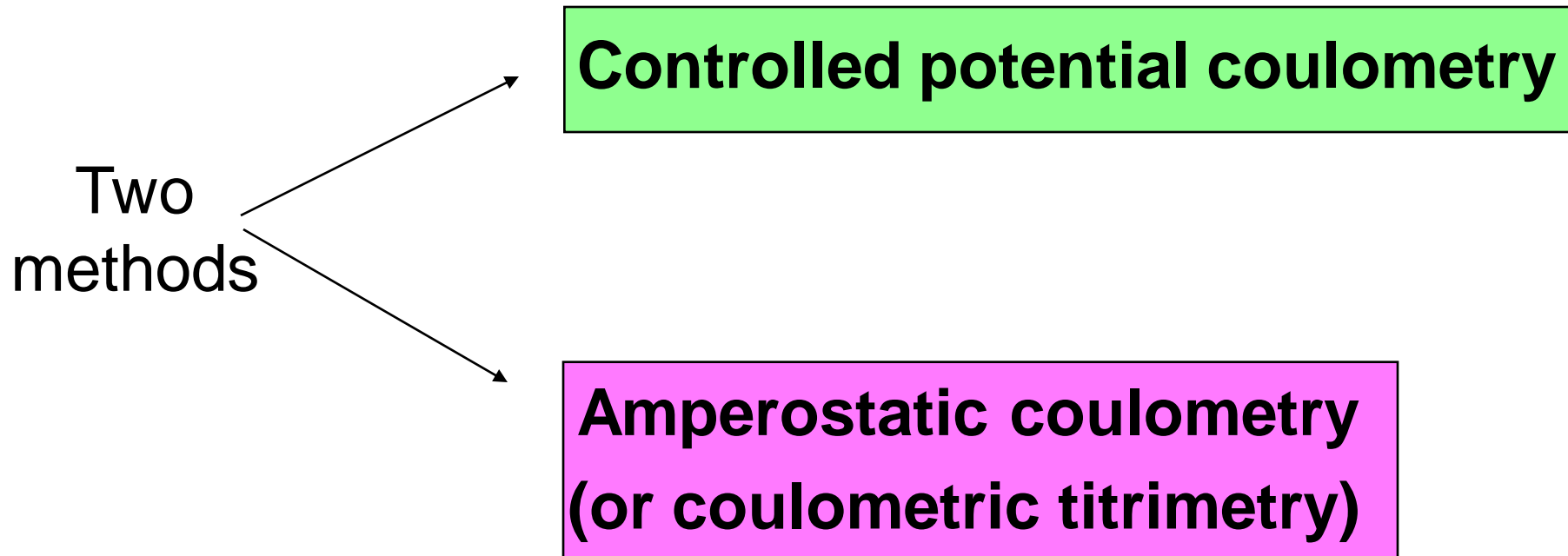

# Controlled potential coulometry

- Similar to controlled potential gravimetric methods
- Potential of the working electrode (WE) is maintained at a constant level relative to the reference electrode (RE) throughout the electrolysis
- Electrolysis current is recorded as a function of time
- The number of coulombs required to convert the analyte to its reaction product is then determined by recording and integrating the current-versus-time curve during the electrolysis



# Minimal potential difference for separation of two species

- Suppose that we desire to separate two substances,  $O_{x_1}$  and  $O_{x_2}$ , which are reduced to  $Red_1$  and  $Red_2$ , respectively

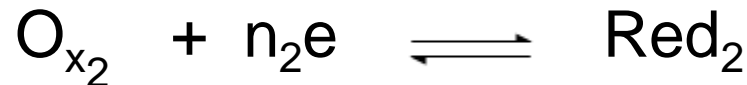
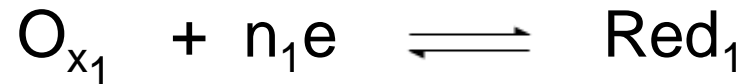

Assume that,

Initial concentrations of  $O_{x_1}$  and  $O_{x_2}$  are identical

$O_{x_1}$  is easily reduced than  $O_{x_2}$

**When all the reactants and products are soluble in an aqueous phase;**

**If  $n_1 = n_2 = 1$**

Standard potentials for the two half-reactions must differ by at least 354 mV to accomplish the desired separation

**If  $n_1 = n_2 = 2$**

Standard potentials for the two half-reactions must differ by at least 177 mV to accomplish the desired separation

**If  $n_1 = n_2 = 3$**

Standard potentials for the two half-reactions must differ by at least 118 mV to accomplish the desired separation

**When both  $O_{x_1}$  and  $O_{x_2}$  are metal cations, are reduced to the elemental state;**

- For the separation by reduction of two univalent metal ions, standard potential should differ by a minimum of **177 mV**
- For the separation by reduction of two divalent metal ions, standard potential should differ by a minimum of **89 mV**
- For the separation by reduction of two trivalent metal ions, standard potential should differ by a minimum of **59 mV**

# Instrumentation

## ❖ Consists of

- an electrolytic cell
- a variable voltage source-potentiostat combination
- a coulometer

Apparatus for controlled potential coulometry

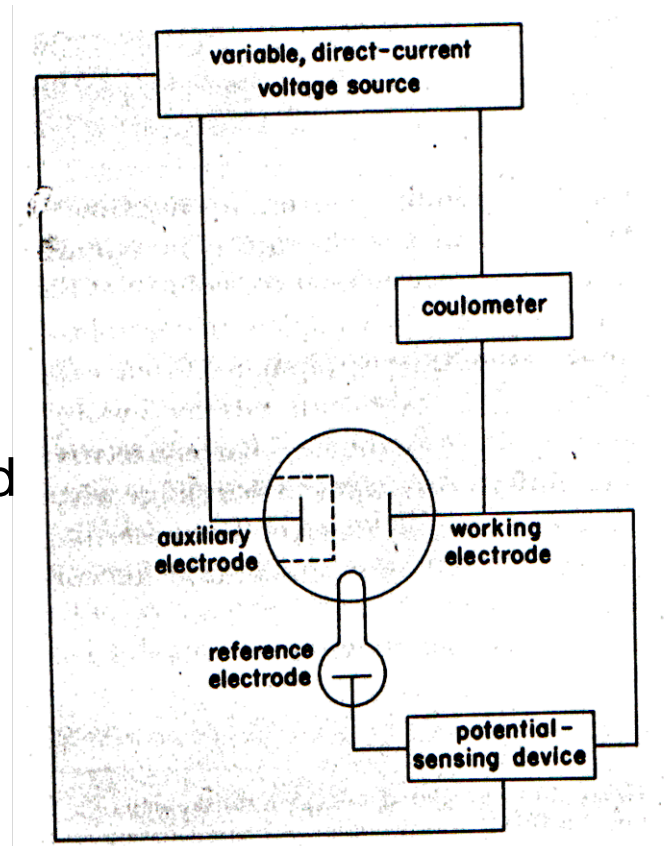

# Electrolytic cell:

- Contains three electrodes;
  - 1. Working electrode** – potential is controlled to permit only one reaction to occur
- Potential of the working electrode is measured and controlled against the reference electrode
- Examples for working electrode – platinum, mercury, gold, carbon and silver

Mercury - easily oxidized (can use as an anode only for reactions of readily oxidizable substances)

Pt, Au, C – much better anode materials

## 2. Auxiliary electrode

- Fabricated from the same material as the working electrode
- Usually situated in a separate compartment of the cell that makes electrolytic contact with the working electrode compartment through a sintered-glass disk to avoid the stirring of the substances formed at the auxiliary electrode to the working electrode at which they would react

## 3. Reference electrode

- Brought in to electrical contact with the sample solution through a salt bridge
  - e.g. Saturated calomel electrode
  - Silver- silver chloride electrode

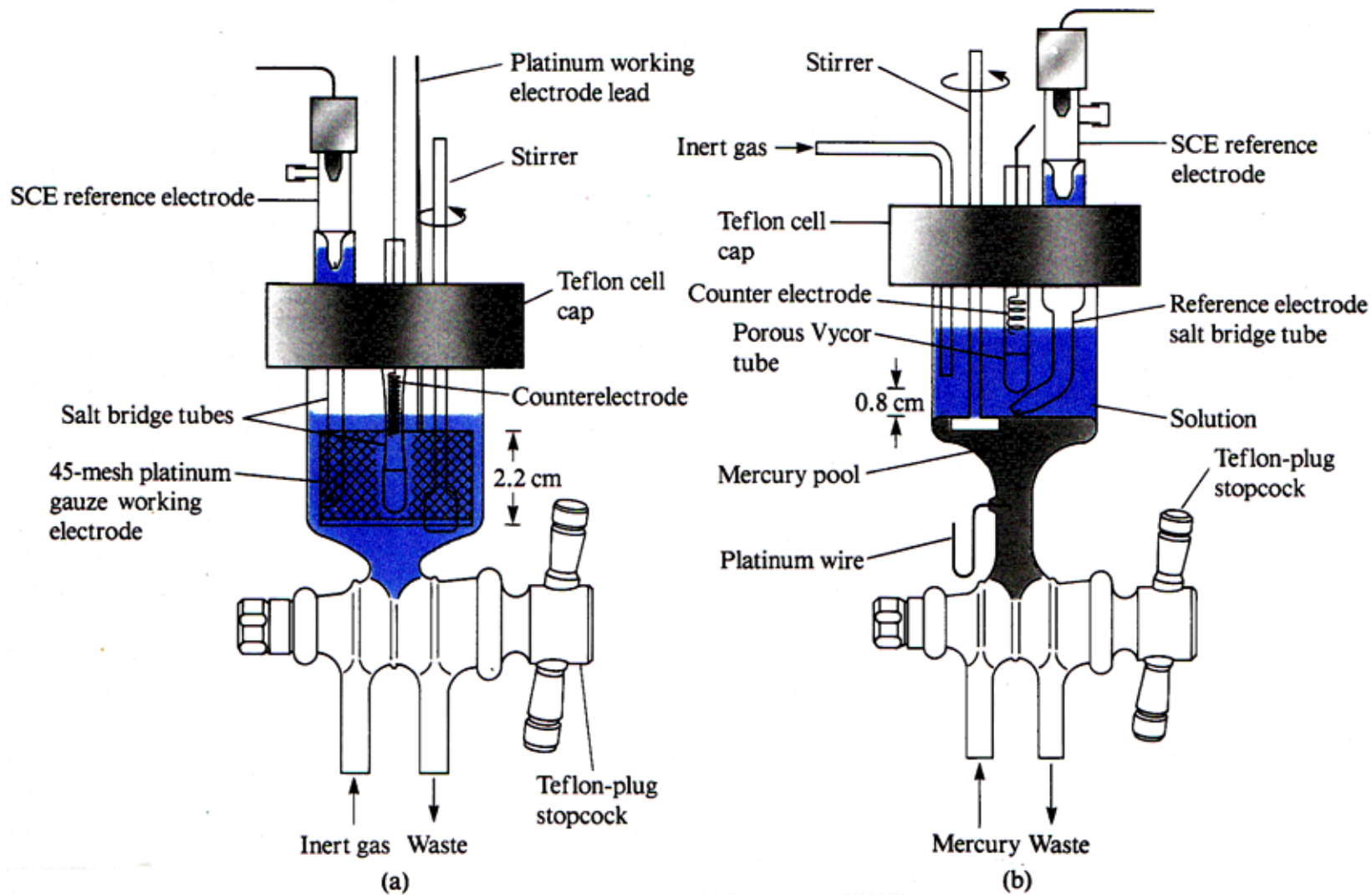

Electrolysis cells for potentiostatic coulometry. Working electrode (a). Platinum gauze, (b). Mercury pool

The above figure illustrates two types of cells that are used for potentiostatic coulometry

**A) Consists of a platinum-gauze working electrode, Pt wire counter electrode and a saturated calomel electrode**

- The counter electrode is separated from the analyte solution by a salt bridge that usually contains the same electrolyte as the solution being analyzed
- The bridge - prevents the reaction products formed at the counter electrode from diffusing into the analyte solution and interfering



## **B) Mercury pool type**

A mercury cathode is particularly useful for separating easily reduced elements as a preliminary step in an analysis

Mercury pool type cell is also useful for –

- Coulometric determination of several metallic cations that form metals that are soluble in mercury
- Coulometric determination of certain types of organic compounds

# Applications of controlled potential coulometry

- **For the determination of inorganic and organic substances**
- **For the electrochemical generation of species that cannot be conveniently prepared by ordinary chemical methods**
- **Cathodic separation and determination of metals**

e.g. analysis of alloys containing Cu, Bi, Pb and Sn

analysis of mixtures containing - Sb, Pb and Sn;

Pb, Cd and Zn;

Ag and Cu;

Ni, Zn, Al and Fe

- **Anodic reaction at Pt and Ag electrodes**

Controlled-potential determinations involving anodic processes at Pt electrodes in 1 M sulfuric acid include the oxidation of Fe(II) to Fe(III), of As(III) to As(V), and of Tl(I) to insoluble Tl(III)

By using silver electrodes possible to determine individual halides as well as halide mixtures

- **Determination (and synthesis) of organic compounds**



- **Widely used in the nuclear-energy field for the relatively interference-free determination of uranium and plutonium**

# Coulometric Titrations

- Based upon the constant-current electrolytic generation of a titrant which reacts quantitatively with the substance to be determined
- Carried out with a constant-current source called an **amperostat**
- Magnitude of the constant current is analogous to the **concentration** of a standard titrant solution
- Time required to complete the titration is equivalent to the **volume** of titrant solution

Therefore, **Current – time product is directly related to the unknown quantity of substance**

e.g. Consider the coulometric titration of Fe(II) at a Pt anode.

At the beginning of the titration, the primary anodic reaction is,



As the concentration of Fe(II) decreases, the requirement of a constant current results in an increase in the applied cell potential

- This causes the anode potential to increase to the point where the decomposition of water becomes a competing process:

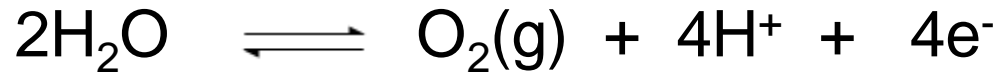

The quantity of electricity required to complete the oxidation of Fe(II) then exceeds that demanded by theory, and the current efficiency is less than 100%. This can be prevented by introducing at the outset, an unmeasured quantity of cerium(III), which is oxidized at a lower potential than is water



- With stirring, cerium(IV) produced is rapidly transported from the surface of the electrode to the bulk, where it oxidizes an equivalent amount of Fe(II)

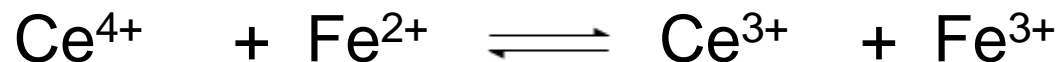

- The net effect is an electrochemical oxidation of Fe(II) with 100% current efficiency, even though only a fraction of that species is directly oxidized at the electrode surface

# End point detection in coulometric titrations

- Coulometric titrations require a means for determining when reaction between analyte and reagent is complete
- End point can be detected by visual methods by using coloured acid-base and redox indicators
- Instrumental techniques of end point detection –
  - potentiometric methods
  - amperometric methods
  - spectrophotometric methods



# Instrumentation

## ❖ Equipment includes

- a source of constant current - **an amperostat**
- a titration vessel
- an electric timer
- a device for monitoring current

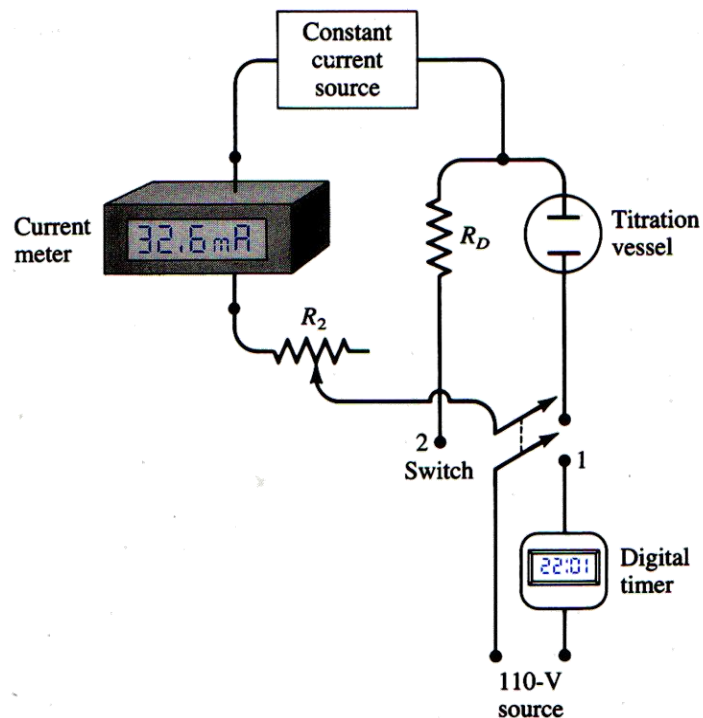
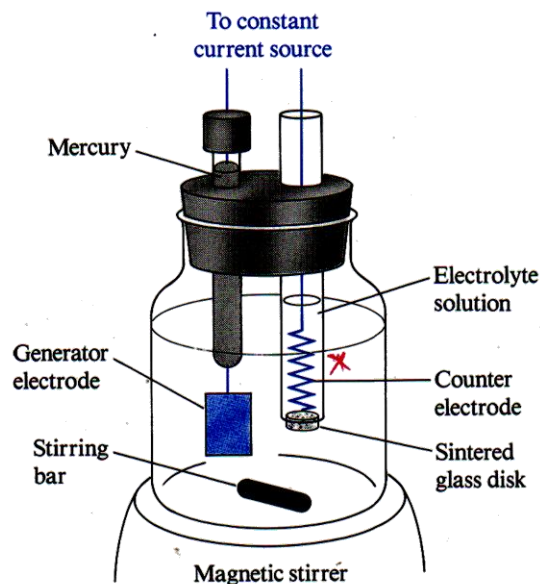

Diagram of a coulometric titration apparatus

- Current is applied to the cell that is in series with a resistor whose resistance is large relative to the resistance of the cell
- Small changes in the cell conductance then have a negligible effect on the current in the resistor and cell

## Cells for coulometric titrations



A typical coulometric titration cell

## ❖ **Generator electrode –**

- Titrant is produced at the generator electrode
- Usually fabricated from Pt, Au, Ag or Hg
- Has a relatively large surface area (10 to 25 cm<sup>2</sup>) to minimize polarization effects

## ❖ **Counter electrode -**

- Usually isolated from the reaction medium by a sintered disk or some other porous disk to prevent interference by the reaction products from this electrode

# Advantages of coulometric titrations

- Coulometric titrations eliminate the problems associated with the preparation, standardization and storage of standard solutions

This is particularly significant with labile reagents such as chlorine, bromine and titanium(II), which are sufficiently unstable in aqueous solutions to seriously limit their use as volumetric reagents

- Coulometric titrimetry is capable of much higher accuracy than ordinary volumetric analysis because the two parameters of interest – **current** and **time** -can be determined experimentally with exceptional precision

- Coulometric methods excel when small amounts of analyte have to be titrated because tiny quantities of reagent are generated with ease and accuracy through the proper choice of current
- Single constant current source provides reagents for precipitation, complex formation, neutralization or oxidation/reduction titrations
- More readily automated since currents are easier to control than **the** control of liquid flow

## ADDITIONAL INFORMATION

### **The effect of current on cell potentials**

- Electrogravimetry and coulometry require a significant current throughout the analytical process
- When there is a current, the cell potential is no longer simply the difference between the electrode potentials of the cathode and anode (thermodynamic potential)
- Two additional phenomena, affect the cell potential
  - I. Ohmic potential drop (IR drop)
  - II. polarization effects

# Ohmic Potential (IR Drop)

- Electrochemical cells resist the flow of charge
- Ohm's law describe the effect of this resistance

$$E = IR$$

Where:

E - Potential drop due to the cell resistance (in volts)

R - Cell resistance (in ohms)

I - Current in the cell (in amperes)

- To develop a current of  $I$  amperes in an electrolytic cell, it is necessary to apply an external potential that is  $IR$  volts larger than the thermodynamic potential,  $E_{\text{cell}}$

$$E_{\text{app}} = E_{\text{cell}} + IR$$

Where:

$E_{\text{app}}$  - Externally applied potential

$E_{\text{cell}}$  - Thermodynamic potential of the cell

**$E_{\text{cell}}$  and  $I$  are positive for an electrolytic process**



# Polarization

- The change of potential of an electrode from its equilibrium potential upon the application of a current is called as **polarization**
- The degree of polarization is described by the overvoltage or overpotential which is symbolized by  $\eta$
- The overpotential represents the extra energy needed (an energy loss that appears as heat) to force the electrode reaction to proceed at a required rate (or its equivalent current density)

$$E_{\text{app}} = E_{\text{cell}} + IR + \eta$$

# Relationship between Applied Voltage, Individual Electrode Potentials and Ohmic potential Drop

- Consider an electrolysis for the reversible zinc-copper cell.

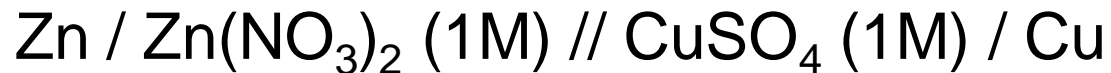

The total voltage ( $E_{\text{app}}$ ) impressed across the anode and cathode,

$$E_{\text{app}} = E_{\text{cell}} + IR$$

$E_{\text{cell}}$  - cell emf based on the surface concentrations of zinc ion and cupric ion + sum of the activation overpotentials for the reduction of Zn(II) and oxidation of Cu

$IR$  - Ohmic potential drop

$$E_{\text{cell}} = E_{\text{Cu}^{2+}, \text{Cu}} + E_{\text{Zn}, \text{Zn}^{2+}}$$

If liquid junction potentials are ignored,

$$E_{\text{cell}} = E_{\text{Cu}^{2+}, \text{Cu}} - E_{\text{Zn}, \text{Zn}^{2+}}$$

Where;

- $E_{\text{Cu}^{2+}, \text{Cu}}$  - actual potential of the Cu electrode  
 $E_{\text{Zn}, \text{Zn}^{2+}}$  - actual potential of the Zn electrode

For each electrode, the actual potential is governed by:

- ❖ Surface concentration of the pertinent metal cation
- ❖ Activation overpotential for the electron transfer reaction occurring at that electrode

Therefore, combining the preceding expressions,

$$E_{\text{cell}} = E_{\text{Cu}^{2+}, \text{Cu}} - E_{\text{Zn}, \text{Zn}^{2+}} + IR$$

Noting that the Cu electrode is the anode of the zinc-copper electrolytic cell and that the Zn electrode is the cathode,

$$E_{\text{app}} = E_{\text{a}} - E_{\text{c}} + IR$$

$E_{\text{a}}$  - Actual anode potential

$E_{\text{c}}$  - Actual cathode potential

$IR$  - Ohmic drop

- **During an electrolysis, various terms in the preceding equation may change with time**

e.g. When  $E_{\text{app}}$  is held constant, the cell resistance ( $R$ ) probably change as electrolysis proceeds, where as the current ( $i$ ) decreases as the reacting species are consumed. If ' $R$ ' and ' $I$ ' change unequally, ' $IR$ ' will vary, and so must the potentials of anode and cathode

- **During a constant-current electrolysis, readjust the applied voltage continuously as the ' $R$ ' varies, but any change in the applied voltage alters cathode and anode potentials**