



GE105

Introduction to Engineering Design

College of Engineering

King Saud University

Lecture 5. *Need Analysis and Problem Definition*

SPRING 2016

Before We Start

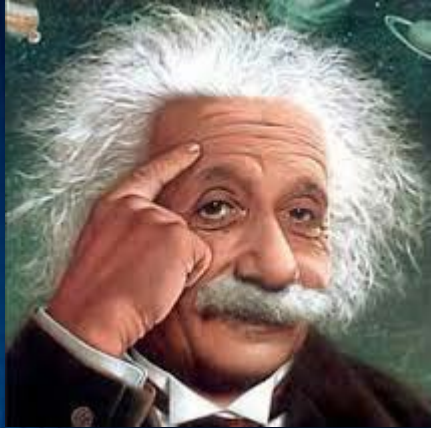

“If I had only one hour to save the world, I’d spend 55 min defining the problem and 5 minutes finding a solution”

“A problem properly stated is half solved”

Charles Kettering (American inventor and the holder of over 300 engineering patents)

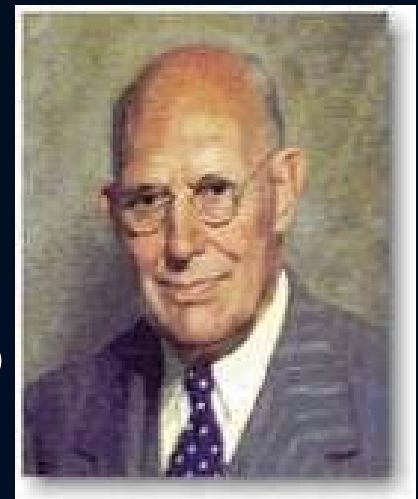

The Big Picture

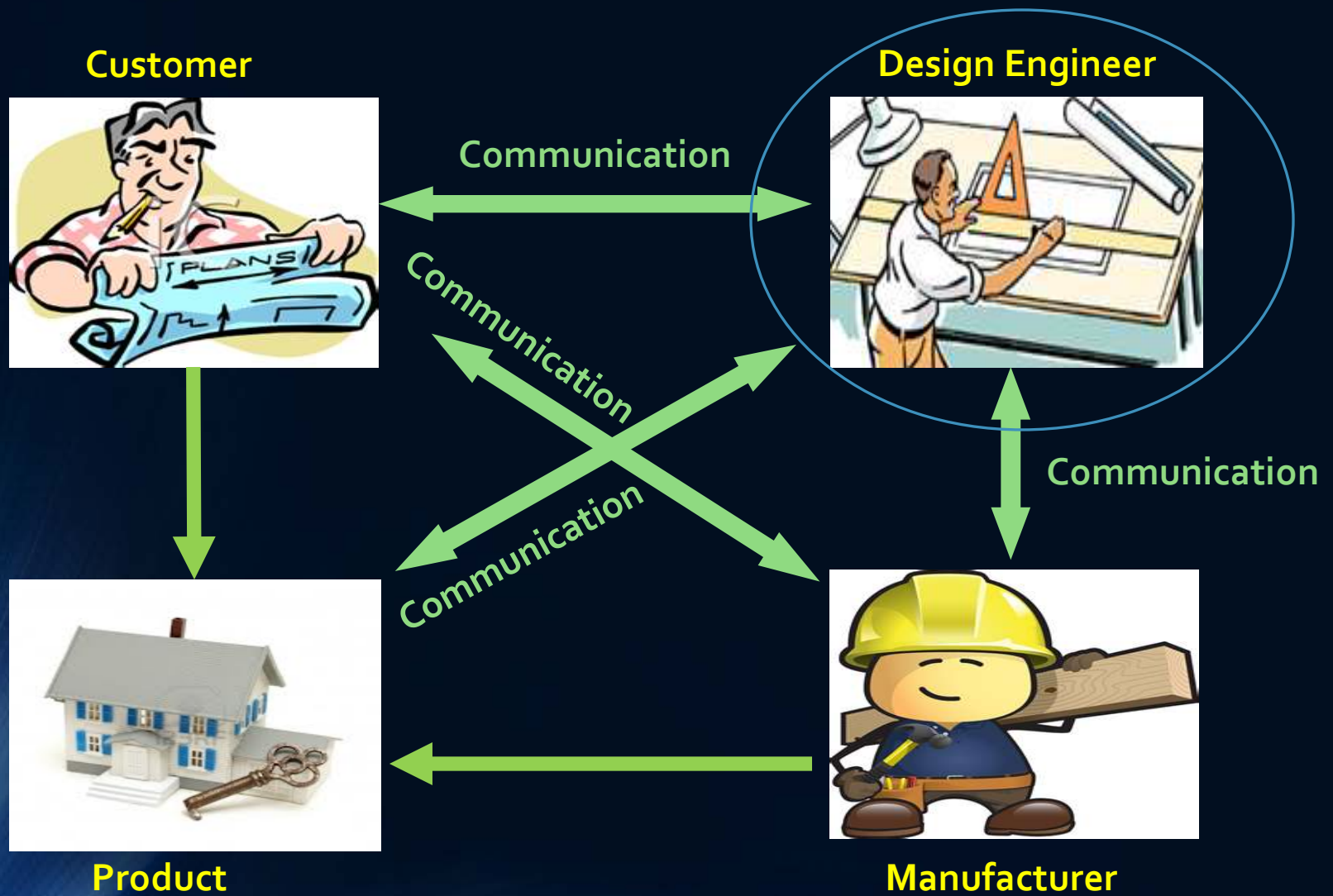

Importance of Communication

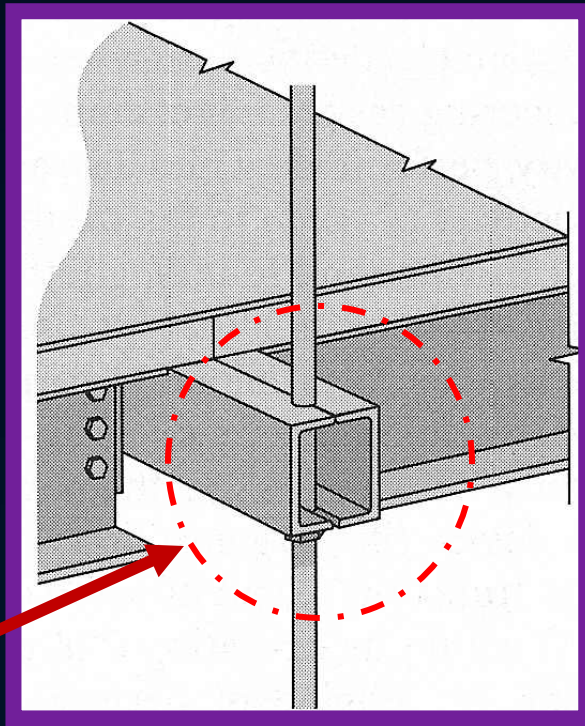

Design

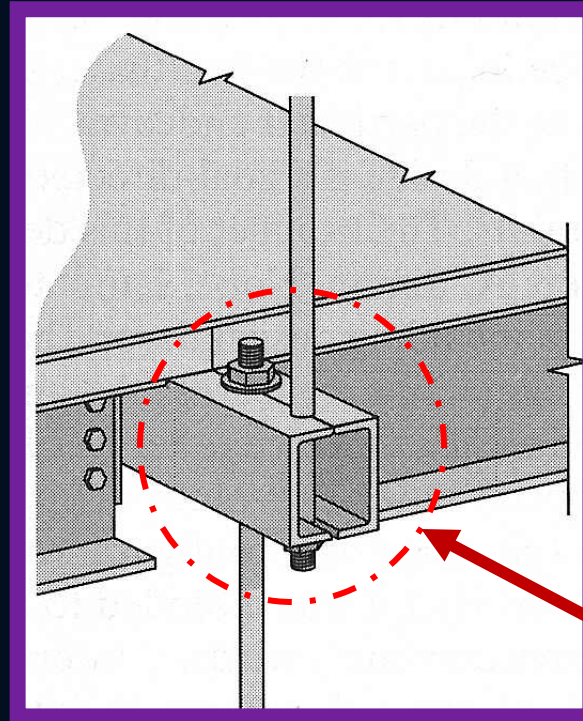

Construction

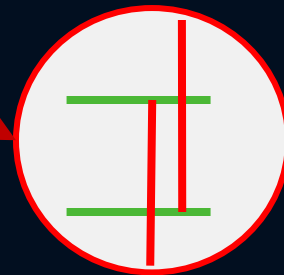
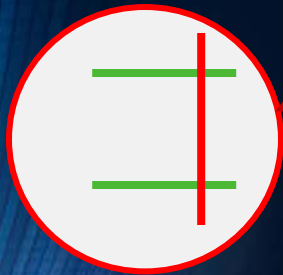

Poor communication between the designer and the construction team lead to the collapse of the second floor
114 people died !!!

Design Process

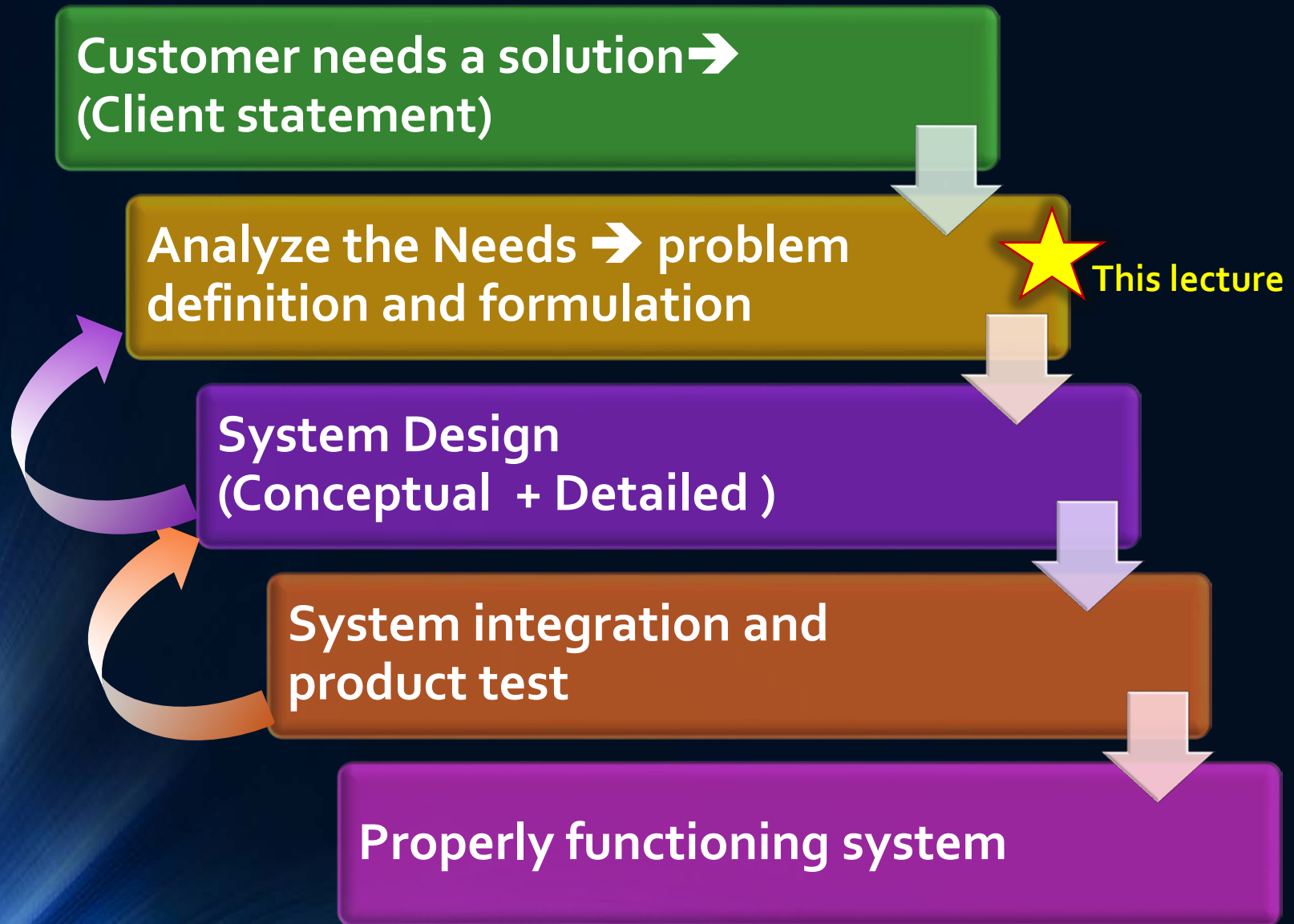

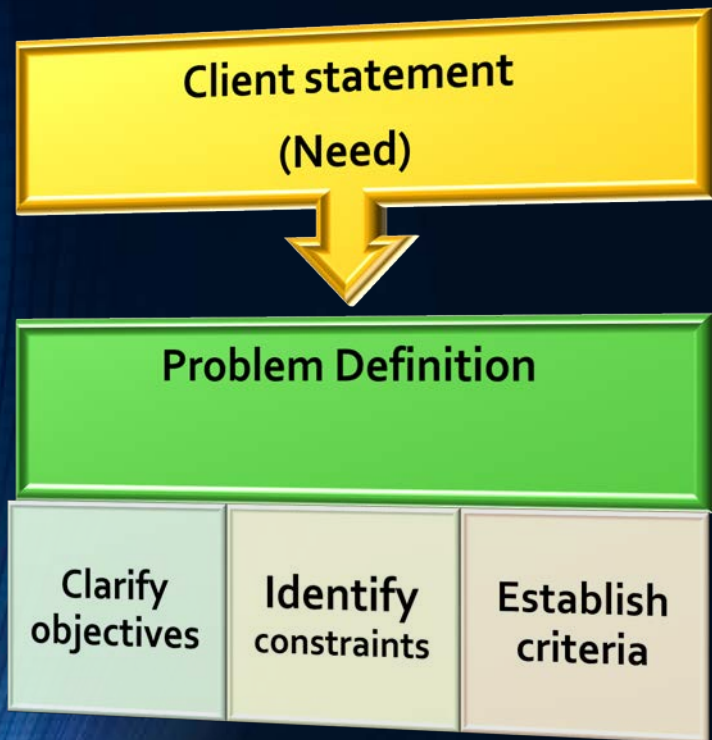

Input	Client Need Statement
Tasks	<ul style="list-style-type: none"> • Talk with the client (interview) • Some potential users (survey) • Brainstorming
Output	<ul style="list-style-type: none"> • Problem statement • Objectives • Constraints • Criteria

Client's Need Statement

- First understand what the problem is (what does the customer want?)
- Often, the customer does not know exactly what s/he wants nor what is achievable
- Client Statements usually have limitations such as:
 - **Bias** (e.g., reconsider admission strategy; whereas the problem could be managing classrooms)
 - **Implied solutions** (e.g., replace the door; whereas another solution can be better)
- Make sure that the correct problem is being addressed



Example

Client Statement:

The residents of one of my tall buildings are complaining that the elevators are slow

Interpretation 1:

you have to install another elevator at great expense

Interpretation 2:

Put entertainment on the main floors and provide some coffee



Problem statement

- The statement is a very short paragraph providing answers to **(What? Why? How?)**
- Written in the language of the customer
- Normally straightforward, non technical and non quantifiable



The Wright brothers Example

- The problem addressed by the Wright brothers at the turn of the 20th century was:

Need a manned machine capable of achieving powered flight

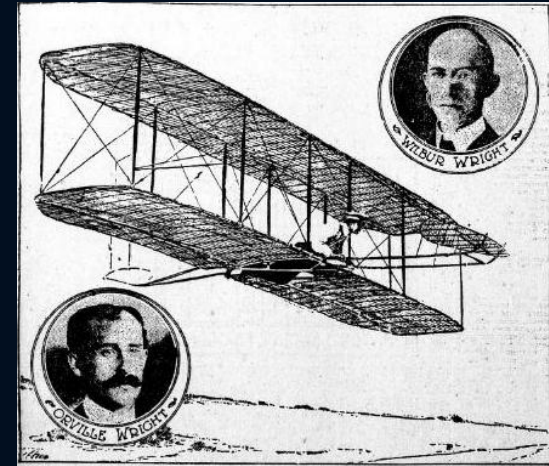

- This means that:

1. They wanted to design a flying machine
2. It must carry a person (which rules out model aircraft)
3. An onboard power source must be used to take off (which eliminates hot air balloons)

How to Assess Needs

- Question the customer
- Explore resources (gathering information)
 - ✓ Technical literature (books, journals, www)
 - ✓ Similar designs (competitors, patent search)



- Search legal and regulatory restrictions
 - ✓ Allocation of frequency bands
 - ✓ Restriction on tower heights
 - ✓ Environmental impacts
 - ✓ Safety
- Brainstorm
- Investigate Manufacturability issues

Types of Specifications

- Design Specs : provide basis for evaluating the design (e.g., safe, light, inexpensive, simple)
- Functional Specs: describe what the product must do (e.g., drilling, grinding, polishing)
- Performance Specs: to judge how good is the design (e.g., speed, energy, accuracy)

- ✓ Use (but don't confuse) "Demanded" design elements and "Wished for" design elements
- ✓ Be as specific as possible by using numbers where possible (e.g., not "heavy" but "2.5 kg")



Common Categories for Specifications

 Performance

 Geometry

 Materials

 Energy

 Time

 Cost

 Manufacturability

 Standards

 Safety

 Transport

 Ergonomics

 Weight

Need Analysis Example Questions:

1. When and why do you use the product?
2. What do you like about existing products?
3. What don't you like about other products?
4. What are the required functions?
5. Who is the product user?
6. Where is the product going to be used (environment)?
7. What are the unacceptable options/behaviors of the product?
8. What should the product satisfy?
9. What specifications do we have/know?
10. Are there any legal issues?
11. What are the human factors to be considered?
12. What is the expected life duration of the product?



Why?
How?
What?
Who?
Where?
When?

Design Objectives

Objectives are the requirements that the design is to satisfy (Specific, Measurable, Achievable, Realistic, Time bound)

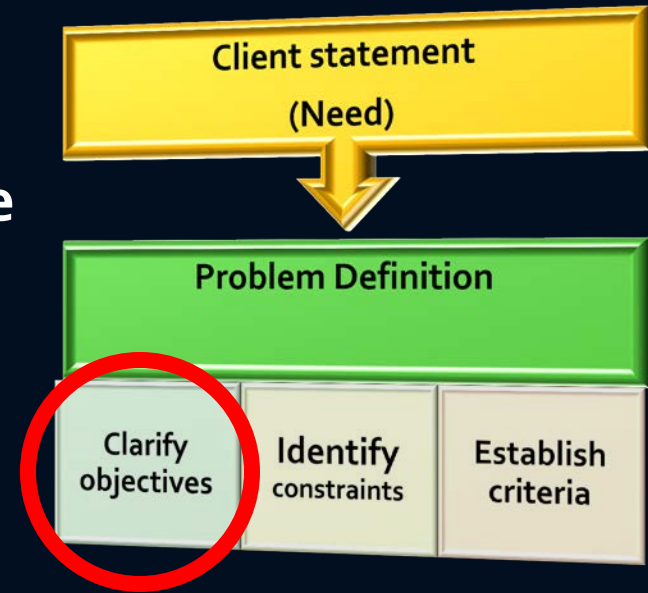

- Construct an **Objective Tree** by:
- Listing objectives according to the assessed needs
- Grouping the relevant objectives
- Forming a hierarchical tree structure

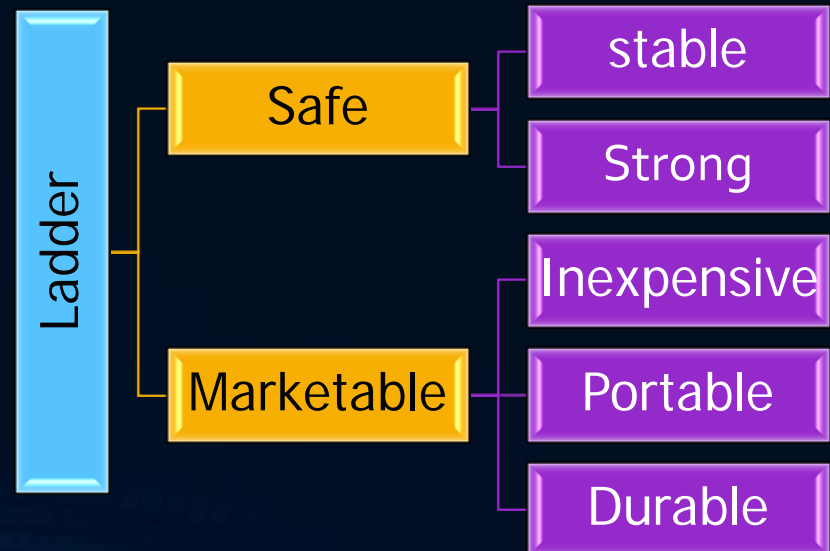

- **The Design Objectives can be divided into:**
 - **Primary (need/must)**
 - **Secondary (wish/want)**
- **The Primary Objective is what the customer/client really needs**
- **Without the primary objective the design is a failure**
- **The Secondary (Less important) Objectives are not necessarily specified; but can have an added value to the product (e.g., Safety, simplicity, beauty)**



Constraints

- Constraints are boundaries that limit the engineer's flexibility. They form the design envelope (feasible design space)
- They help to identify acceptable designs
- Should be measurable
- Should be answered with True/False; Yes/No
 - Example: Cost <1000 SAR
Weight <500 N
Flexible system (yes/no)

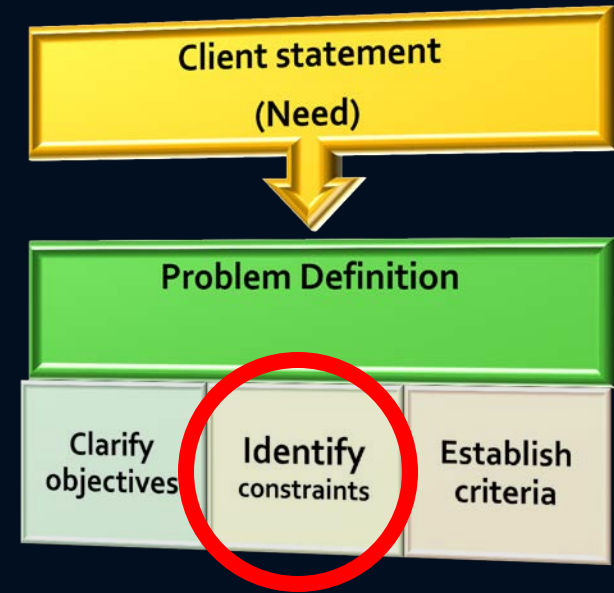

Sources of Constraints

- **Cost:** Cost of design, production, maintenance, support
- **Time:** delivery dates, processing, time to market
- **Legal, ethical:** Patents, intellectual property, product reliability, safety requirements
- **Physical:** size, weight, power, durability
- **Natural factors:** topography, climate, resources
- **Company practices:** Common parts, manufacturing processes
- **Human Factors/Ergonomics**
- **Sustainability**
- **Environment:** Bio-degradable materials, recycled materials, green energy



Design Criteria

- Criteria are indicators defining the success of achieving the objectives
- Criteria define the product physical and functional characteristics
- They represent descriptive **adjectives** that can be **qualified on a given scale**: examples: beautiful, low cost, low noise, smart, low weight
- Might be used for judging between different designs

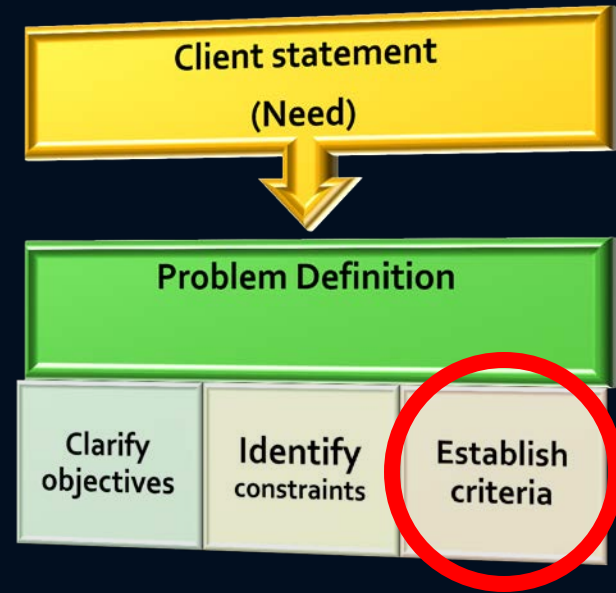
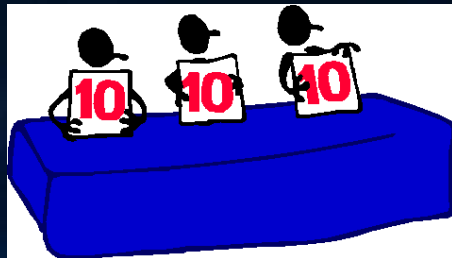

Examples of Criteria

To be Qualified say on a scale 1 to 10
1 (worst) and 10 (best)

- High safety
- Environment friendliness
- Public Acceptance
- Performance
- Ease of operation
- Durability
- Cost
- Ease of Maintenance
- Ease of Manufacturing
- Aesthetic design (Appearance)
- Geometry
- Physical Features
- Reliability
- Use Environment

Example : Specs for designing an" Auto-golfer"

Geometry	D	Single unit, 3 foot circle
Materials	W	Not degrade in rain snow, 30°F
Time	D	Ready to go < 14 weeks
Cost	D	≤ \$600 (exclusive of radios)
Manufacture	W	Off-the-shelf parts as possible
Standards	D	Radios OK for FAA regulations
Safety	D	Must pass safety review
Transport	D	Must be portable
Compactness	W	Should fit in a car or small truck

D=demand

W=wish



Problem Definition

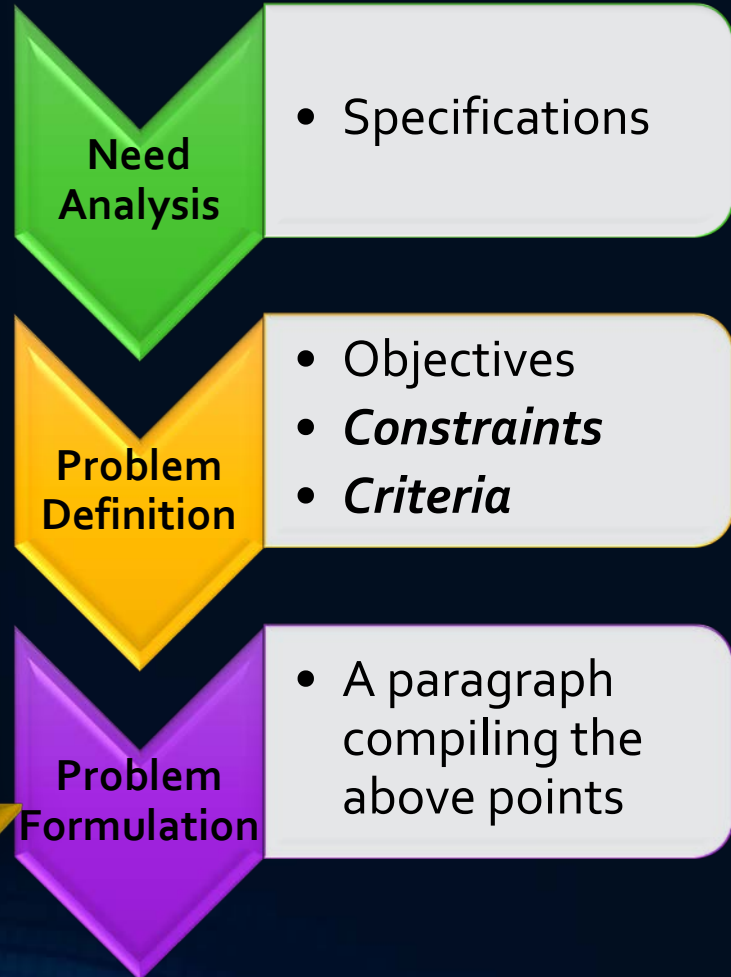
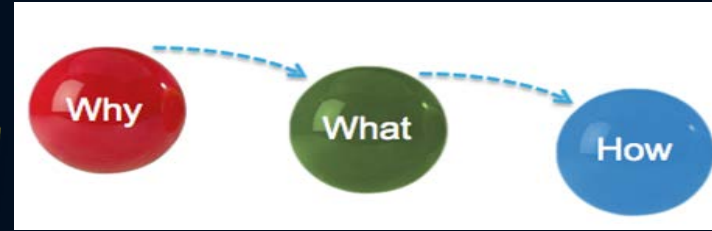

To summarize

Need Analysis

- Needs that are well understood
- A well stated objective
- A list of Demanded and Wished for Specifications
- A set of criteria
- A set of constraints

Problem Definition

- Turn the problem statement into a technical, quantified problem definition
- Precise description of the properties of the object being designed
- Can be a long list

Problem Formulation

- A compiled carefully written paragraph