

$\langle S \rangle \rightarrow \langle A \rangle$   
 $\langle A \rangle \rightarrow \langle A \rangle + \langle A \rangle \mid \langle id \rangle$   
 $\langle id \rangle \rightarrow a \mid b \mid c$

Jun 25-4:19 PM

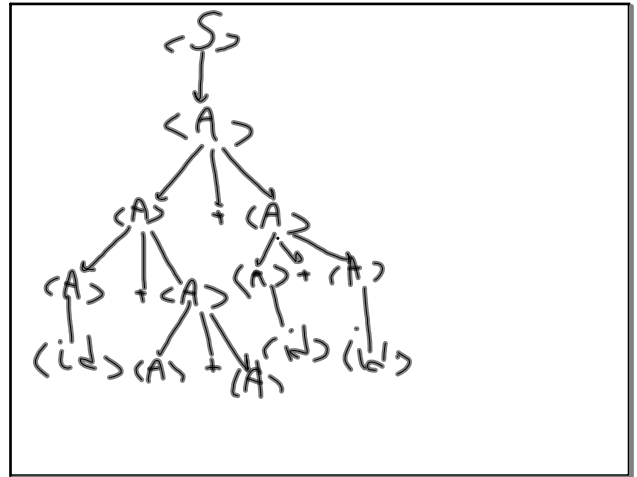

Jun 25-4:21 PM

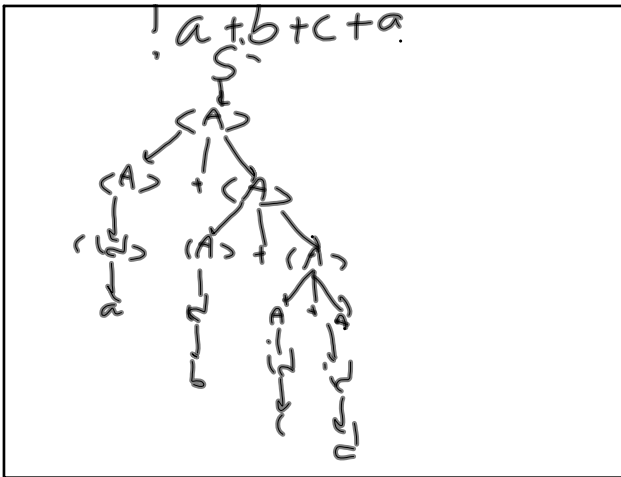

Jun 25-4:23 PM

**Example**  
 $\langle S \rangle \rightarrow \langle A \rangle \langle B \rangle \langle C \rangle$   
 $\langle A \rangle \rightarrow a \langle A \rangle \mid a$   
 $\langle B \rangle \rightarrow b \langle B \rangle \mid b$   
 $\langle C \rangle \rightarrow c \langle C \rangle \mid c$

Jun 25-4:27 PM

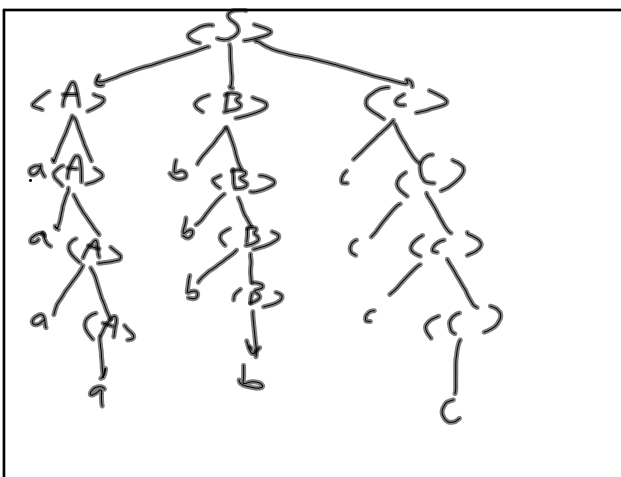

Jun 25-4:28 PM

$(a)^* = \begin{cases} \epsilon \\ aaaaaa \end{cases}$   
 $\langle S \rangle \rightarrow a b c$   
 $\langle S \rangle \rightarrow \langle A \rangle \langle B \rangle \langle C \rangle$   
 $\langle A \rangle \rightarrow a \langle A \rangle$   
 $a(a)^*$

Jun 25-4:32 PM

$L =$   
 $a a^* b b^* c c^*$

Jun 25-4:35 PM

$\langle S \rangle \rightarrow \langle A \rangle a \langle B \rangle b$   
 $\langle A \rangle \rightarrow \langle A \rangle b \mid b$   
 $\langle B \rangle \rightarrow a \langle B \rangle \mid a$

baab  
 bbbab

Jun 25-4:36 PM

bbbab

Jun 25-4:40 PM

$bbaaaaa$   
 $bbab$

Jun 25-4:42 PM

construct a grammar  
 that generates  
 $a^* b^*$

$\langle S \rangle \rightarrow \langle A \rangle \langle B \rangle$   
 $\langle A \rangle \rightarrow a \langle A \rangle \mid \epsilon$   
 $\langle B \rangle \rightarrow b \langle B \rangle \mid \epsilon$

Jun 25-4:44 PM

construct a grammar  
 that generates  $a^n b^n$   
 with the same number of  
 a and b

$\langle S \rangle \rightarrow \langle A \rangle a \langle B \rangle b$   
 $\langle A \rangle \rightarrow a \langle A \rangle b \mid \epsilon$

ab  
 aabb  
 aaabbb

Jun 25-4:47 PM

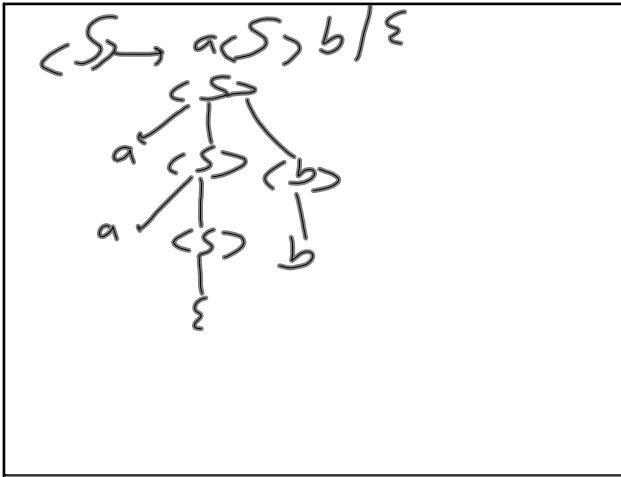

Jun 25-4:50 PM

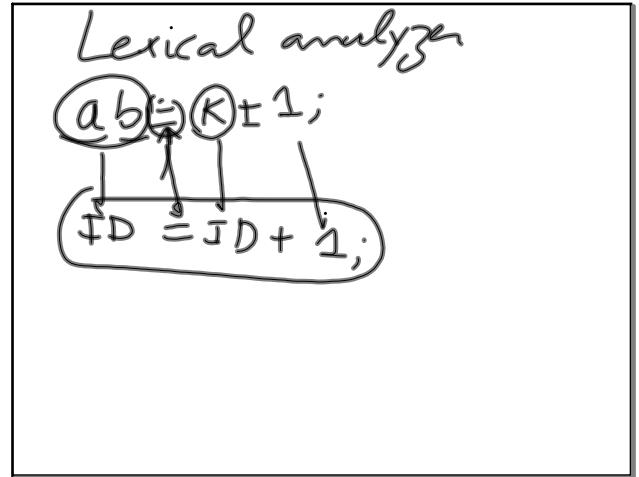

Jun 25-4:52 PM

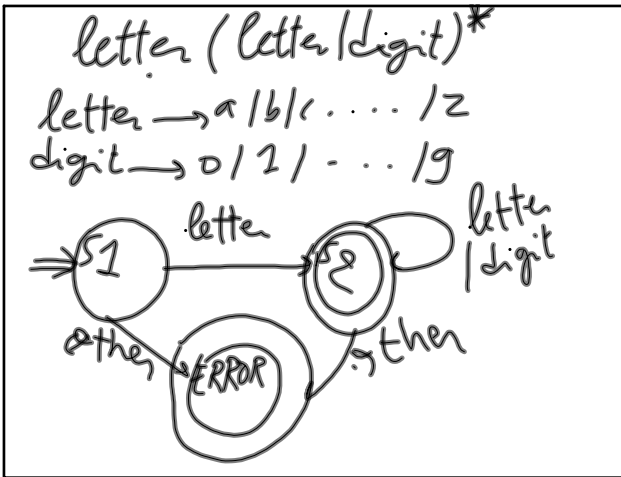

Jun 25-4:56 PM

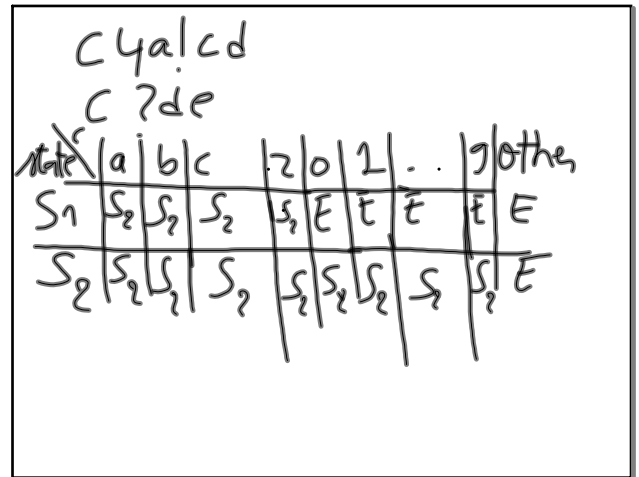

Jun 25-5:01 PM

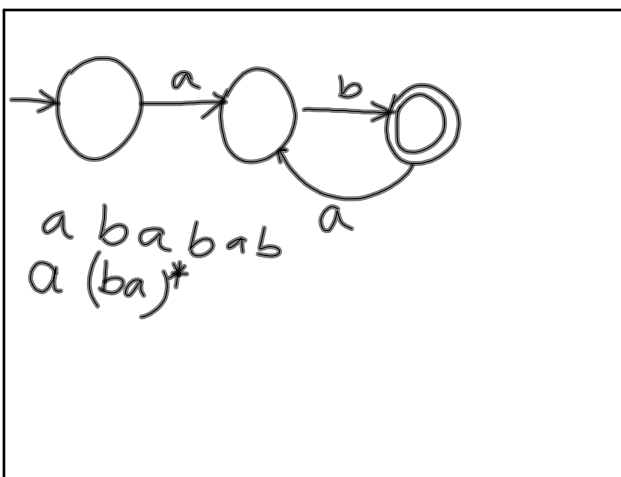

Jun 25-5:08 PM

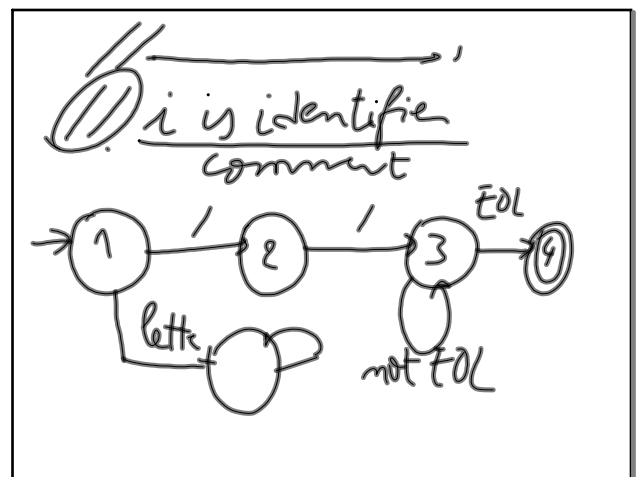

Jun 25-5:11 PM

comment c  
 /\* num \*/  
 /c4dB  
 ERROR

Jun 25-5:14 PM

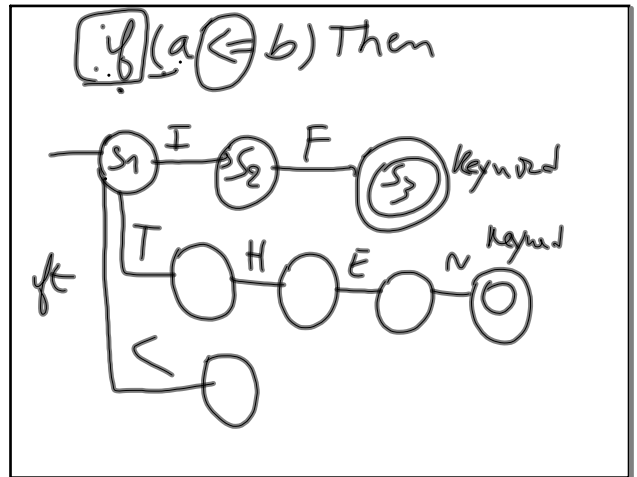

Jun 25-5:18 PM

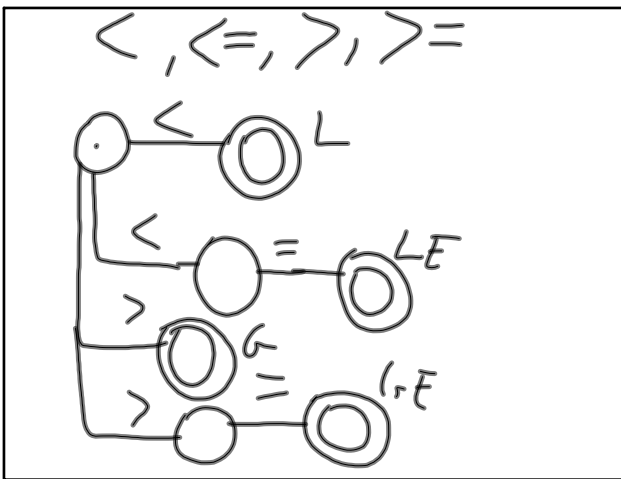

Jun 25-5:23 PM

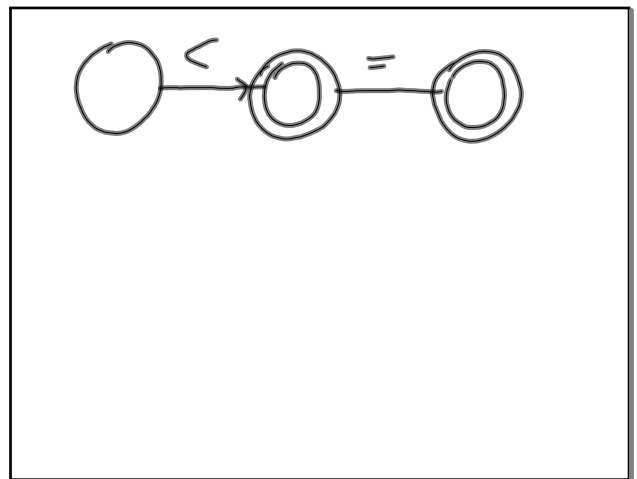

Jun 25-5:25 PM

float numbers  
 $\Rightarrow \pm 12.45$   
 $\rightarrow 12$   
 $+12$   
 $\rightarrow +12.45$

Jun 25-5:30 PM

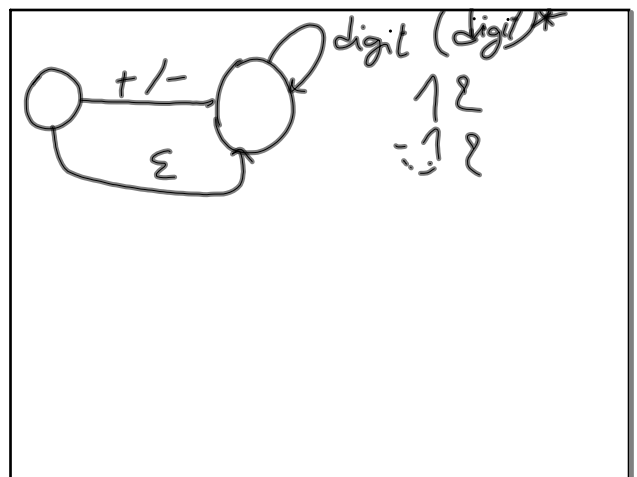

Jun 25-5:32 PM

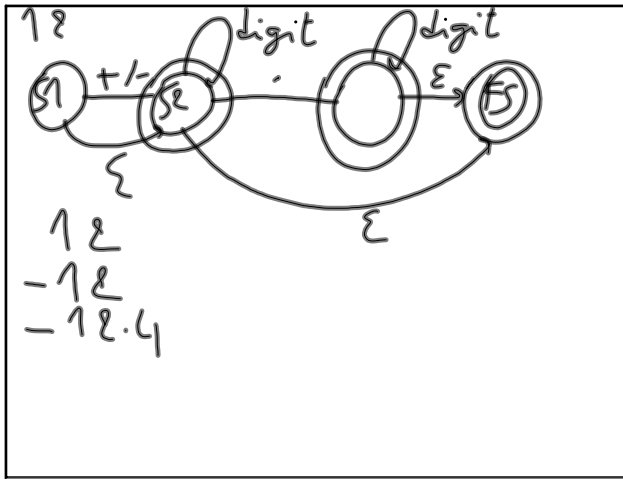

Jun 25-5:35 PM

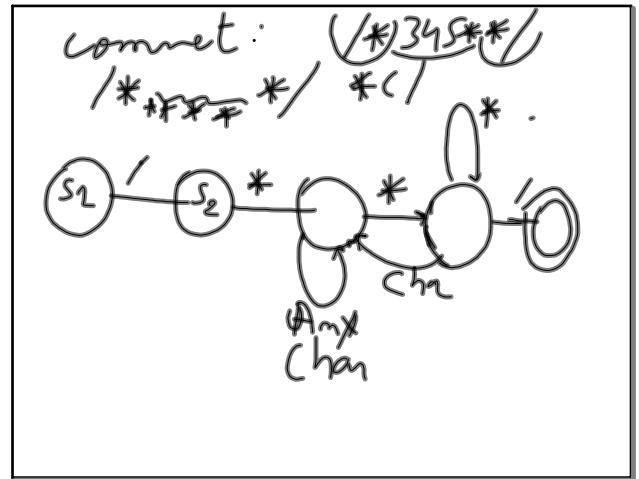

Jun 25-5:40 PM

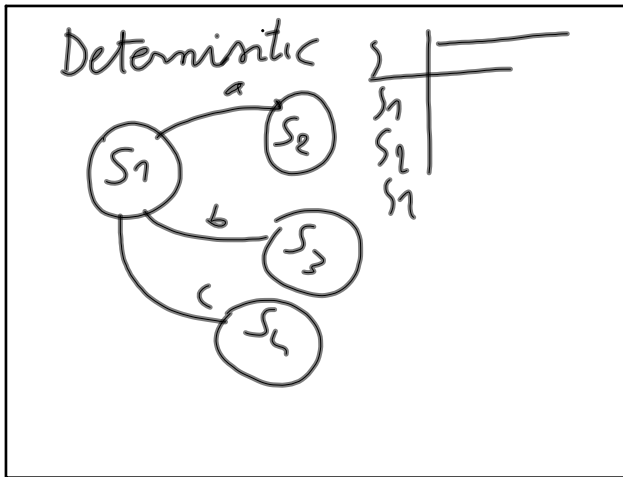

Jun 25-5:50 PM

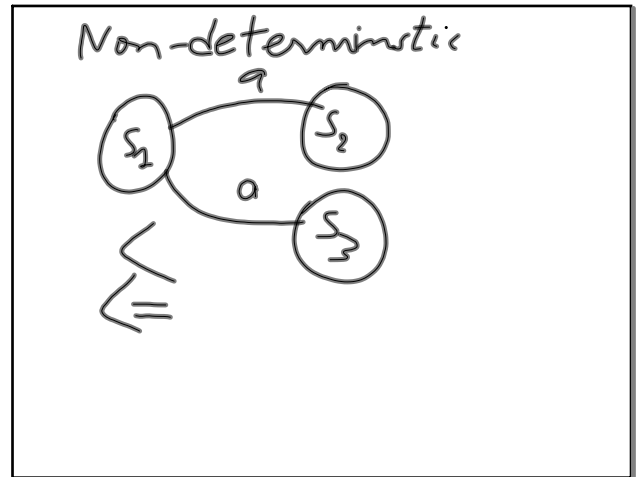

Jun 25-5:51 PM

a ~ a  
 a (letter)\* a  
 letter → a/b/. . 1 2  
 a\*

Jun 25-5:59 PM

straj: a, b  
 but no 3 consecutive b  
 a\* b b a\*  
 → a\* b | a\* b b | a\*

Jun 25-6:02 PM

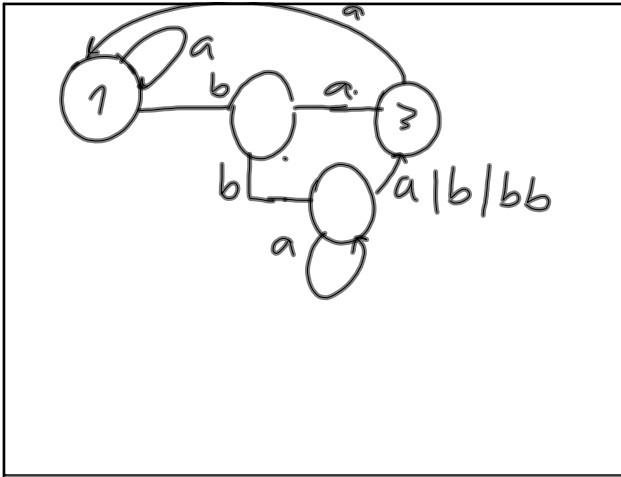

Jun 25-6:04 PM

```

main {
  const float A=3.5;
  if (A>4)
  { printf("PH");
  }
}
key { key key ID=VALUE;
      key (ID) VALUE;
      key (-);
}
    
```

Jun 25-6:11 PM

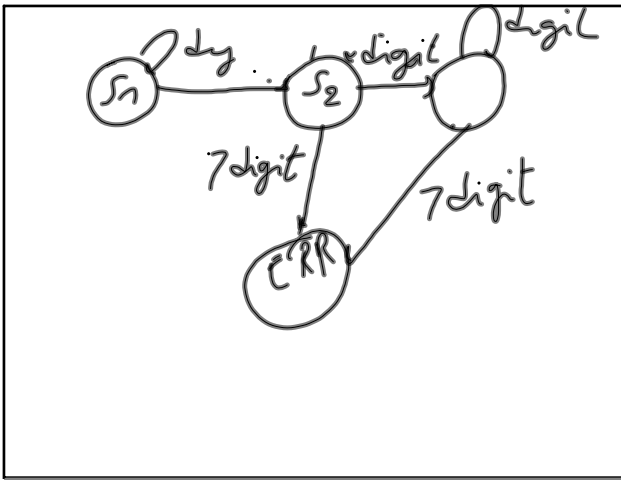

Jun 25-6:15 PM

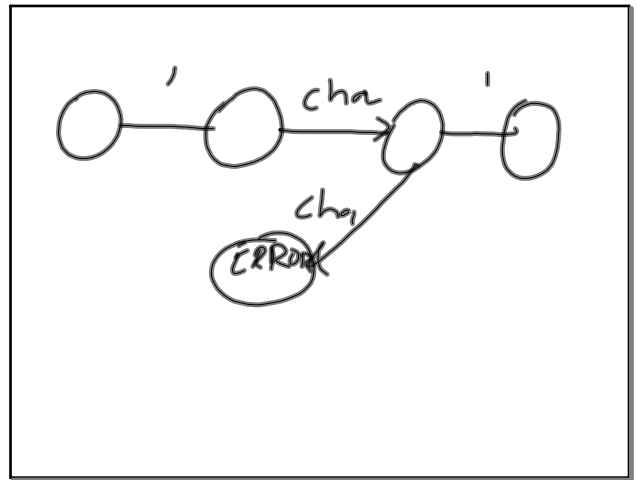

Jun 25-6:19 PM

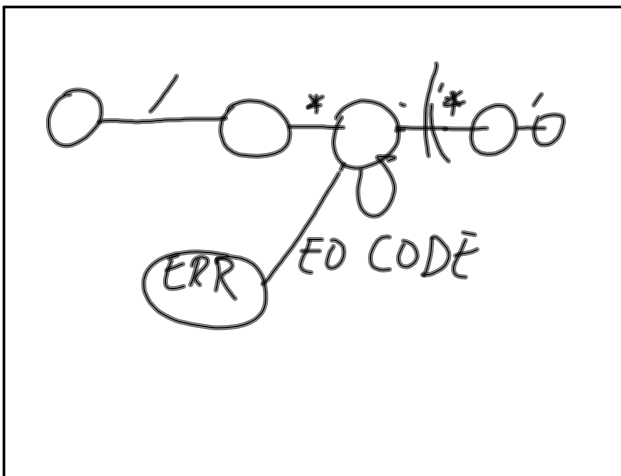

Jun 25-6:20 PM

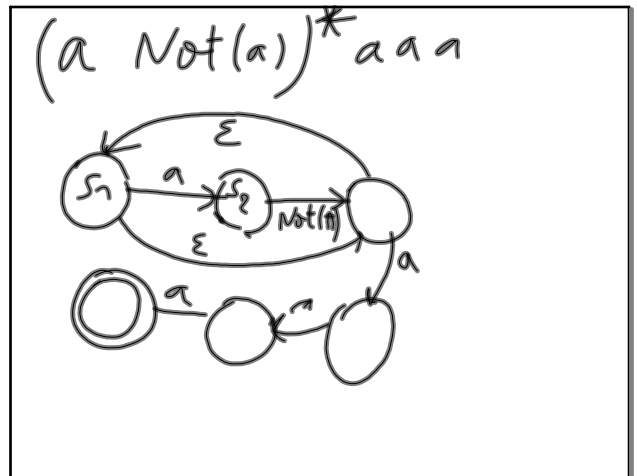

Jun 25-6:26 PM

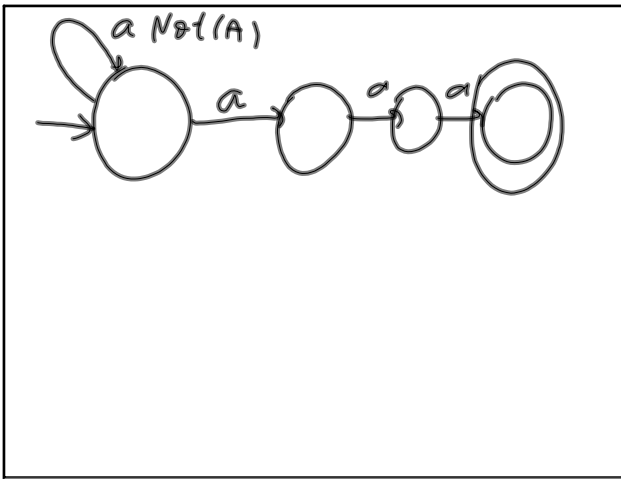

Jun 25-6:29 PM

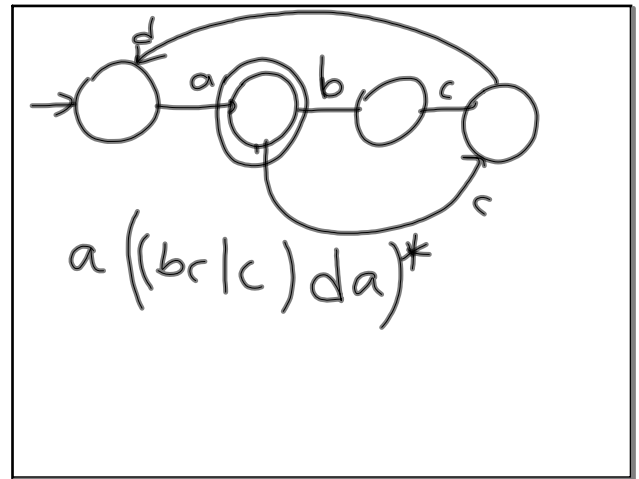

Jun 25-6:32 PM